



Lithium Ion Jump Starter and USB Power Source

OWNERS MANUAL

FOR MODELS

SL1596

SL1610

SL1611

SL1612

PLEASE SAVE THIS OWNERS MANUAL AND READ BEFORE EACH USE. This manual will explain how to use the unit safely and effectively. Please read and follow these instructions and precautions carefully.

CONTENTS

IMPORTANT SAFETY INSTRUCTIONS – SAVE THESE INSTRUCTIONS.....	3
PERSONAL SAFETY PRECAUTIONS	3
FEATURES.....	4
CONTROL PANEL.....	4
CHARGING THE INTERNAL BATTERY OF THE JUMP STARTER.....	4
OPERATING INSTRUCTIONS.....	5
MAINTENANCE AND STORAGE.....	5
TROUBLESHOOTING	5
REPLACEMENT PARTS	5
SPECIFICATIONS	5
BEFORE RETURNING FOR REPAIRS	5
LIMITED WARRANTY	5

Lithium Ion Jump Starter and USB Power Source

OWNERS MANUAL

FOR MODELS

SL1596

SL1610

SL1611

SL1612

PLEASE SAVE THIS OWNERS MANUAL AND READ BEFORE EACH USE. This manual will explain how to use the jump starter safely and effectively. Please read and follow these instructions and precautions carefully.

1. IMPORTANT SAFETY INSTRUCTIONS – SAVE THESE INSTRUCTIONS.

WARNING: RISK OF EXPLOSIVE GASES.

WORKING IN THE VICINITY OF A LEAD-ACID BATTERY IS DANGEROUS. BATTERIES GENERATE EXPLOSIVE GASES DURING NORMAL OPERATION. IT IS IMPORTANT THAT YOU FOLLOW THESE INSTRUCTIONS EACH TIME YOU USE THE UNIT.

To reduce the risk of battery explosion, follow these instructions and those published by the battery manufacturer and the manufacturer of any equipment you intend to use in the vicinity of a battery. Review cautionary markings on these products and on the engine.

WARNING! RISK OF ELECTRIC SHOCK OR FIRE.

- 1.1 Keep out of reach of children.
- 1.2 Do not disassemble the jump starter. Take it to a qualified service professional if service or repair is required. Incorrect assembly may result in fire or electrical shock.
- 1.3 Do not use the jump starter to jump a vehicle while charging the internal battery.
- 1.4 Do not recharge the jump starter with a damaged USB cable.
- 1.5 The jump starter gets hot during charging and must have proper ventilation.
- 1.6 Do not set the jump starter on flammable materials, such as carpeting, upholstery, paper, cardboard, etc.
- 1.7 Place the jump starter as far away from the battery being jumped as the cables will permit.
- 1.8 Do not expose the jump starter to rain or snow.
- 1.9 Never attempt to jump start a frozen battery.
- 1.10 Never place the jump starter directly above battery being jumped.
- 1.11 To prevent arcing, never allow the clamps to touch together or to contact the same piece of metal.
- 1.12 Use of an attachment not recommended or sold by the jump starter manufacturer may result in damage to the unit or personal injury.
- 1.13 Never operate the jump starter if it is damaged.
- 1.14 If someone else uses the jump starter, ensure they are well informed on how to use it safely, and have read and understood the operating instructions.
- 1.15 The jump starter is NOT designed to be installed as a replacement for a vehicle battery.
- 1.16 Use ONLY on vehicles, boats and garden tractors powered with a 12V DC battery system.
- 1.17 If the engine fails to start after the recommended number of attempts, disconnect the unit and look for other problems that may need to be corrected.
- 1.18 Use the jump starter for jump starting lead-acid batteries only. Do not use for dry cell batteries that are commonly used with home appliances.

2. PERSONAL SAFETY PRECAUTIONS

- 2.1 Wear complete eye protection and protective clothing when working near lead-acid batteries. Always have someone nearby for help.
- 2.2 Have plenty of fresh water, soap and baking soda nearby for use, in case battery acid contacts your eyes, skin, or clothing. Wash immediately with soap and water and seek medical attention.
- 2.3 If battery acid comes in contact with eyes, flush eyes immediately and get medical attention.
- 2.4 Neutralize any acid spills thoroughly with baking soda before attempting to clean up.
- 2.5 Remove all personal metal items from your body, such as rings, bracelets, necklaces and watches. A battery can produce a short circuit current high enough to weld a ring to metal, causing a severe burn.
- 2.6 Never smoke or allow a spark or flame in the vicinity of the battery or engine.
- 2.7 **This product contains a lithium ion battery.** In case of fire, you may use water, a foam extinguisher, Halon, CO₂, ABC dry chemical, powdered graphite, copper powder or soda (sodium carbonate) to extinguish the fire. Once the fire is extinguished, douse the product with water, an aqueous-based extinguishing agent, or other nonalcoholic liquids to cool the product and prevent the battery from re-igniting. NEVER attempt to pick up or move a hot, smoking, or burning product, as you may be injured.
- 2.8 Changes or modifications not expressly approved by Schumacher Electric could void the user's authority to operate this device.
- 2.9 **NOTE:** This equipment has been tested and found to comply with the limits for a Class B digital device, pursuant to part 15 of the FCC Rules. These limits are designed to provide reasonable protection against harmful interference in a residential installation. This equipment generates, uses, and can radiate radio frequency energy and, if not installed and used in accordance with the instructions, may cause harmful interference to radio communications. However, there is no guarantee that interference will not occur in a particular installation. If this equipment does cause harmful interference to radio or television reception, which can be determined by turning the equipment off and on, the user is encouraged to try to correct the interference by one or more of the following measures:
 - Reorient or relocate the receiving antenna.
 - Increase the separation between the equipment and receiver.
 - Connect the equipment into an outlet on a circuit different from that to which the receiver is connected.
 - Consult the dealer or an experienced radio/TV technician for help.

3. FEATURES

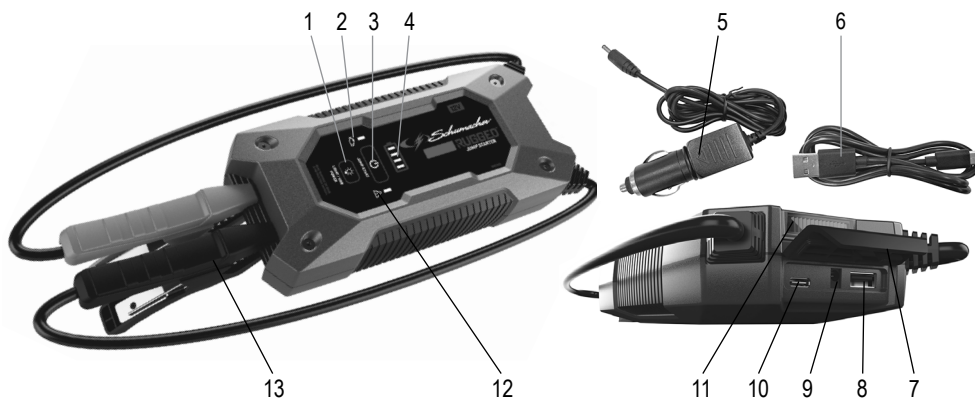

1. Light/USB Power button
2. Ready LED
3. Jump start button
4. Battery status indicators
5. 12V DC car charger
6. USB charging cable
7. Port cover
8. USB output port
9. 12V input port
10. USB input port
11. Built-in work light
12. Fault LED
13. Battery clamps
14. Not shown:
Carry bag

4. CONTROL PANEL

4.1 LED INDICATOR

Battery status LED (WHITE) flashing: The internal battery is charging.

Ready LED (GREEN) solid: The unit is ready to jump start.

Ready LED (GREEN) flashing: The unit is ready to override.

Fault LED (RED) solid: Short circuit connected or clamps reversed.

4.2 FUNCTION BUTTONS

 **Light/USB Power button:** Press the button to turn on the power and check the battery status. Press the button and hold to turn on the work light.

NOTE: The unit will automatically turn off if not used for 30 seconds.

 **Jump start:** Press the button to jump start your vehicle. Press the  **Light/USB Power** and  **Jump Start** buttons and hold for 5 seconds, to jump start your vehicle with low voltage. See section 6.2 for expanded instructions.

5. CHARGING THE INTERNAL BATTERY OF THE JUMP STARTER

IMPORTANT: CHARGE IMMEDIATELY AFTER PURCHASE, AFTER EACH USE AND EVERY 30 DAYS, TO KEEP THE JUMP STARTER'S INTERNAL BATTERY FULLY CHARGED AND PROLONG BATTERY LIFE.

5.1 CHECKING THE LEVEL OF THE INTERNAL BATTERY

Press the  **Light/USB Power** button on the front of the unit. The LEDs will indicate the current charge level as follows:

- ● ● ● 100% charged
- ● ● 75% charged
- ● 50% charged
- 25% charged

Charge the internal battery if the LEDs indicate less than 75%.

5.2 CHARGING THE INTERNAL BATTERY

NOTE: Use a 2A USB charger (not included), or a 2A USB charging port to quickly recharge the jump starter. Using a charger with less than 2A will increase charge time.

1. Plug the  USB end of a charging cable into the input port. Next, plug the USB end of the charging cable into your charger's USB port.
2. Plug your charger into a live AC or DC power outlet.
3. Approximate time to fully charge the jump starter (with 2A charger):

SL1596: 7-8 hours

SL1610: 4-5 hours

SL1611: 5-6 hours

SL1612: 6-7 hours

When the unit is fully charged, all four white LEDs turn solid for a short time, and then shut off.

4. When the battery is fully charged, disconnect your charger from the outlet and then remove the charging cable from the charger and the unit.
5. Charge the unit as soon as possible after use.

5.3 CHARGING THE INTERNAL BATTERY WHILE DRIVING

You may also charge the internal batteries while driving, using the 12V DC car charger (included).

1. Make sure the car is running.
2. Plug the 12V DC adaptor cable into the unit's 12V input socket.
3. Insert the other end of the accessory cable into the vehicle's accessory outlet.
4. Approximate time to fully charge the jump starter:

SL1596: 4 hours

SL1610: 2 hours

SL1611: 3 hours

SL1612: 3.5 hours

When the unit is fully charged, all four white LEDs turn solid for a short time, and then shut off.

5. When the battery is fully charged, disconnect your charger from the power source and then remove the charging cable from the charger and the unit.
6. Charge the unit as soon as possible after use.

NOTE: Completely disconnect the charger cable when the engine is not running.



6. OPERATING INSTRUCTIONS

6.1 JUMP STARTING A VEHICLE

IMPORTANT: Using the jump starter without a battery installed in the vehicle will damage the vehicle's electrical system.

1. Turn the ignition OFF.
2. Lay the DC cables away from any fan blades, belts, pulleys and other moving parts.

NOTE: Make sure all of the vehicle's electrical devices are turned off.

3. For a negative-ground vehicle (as in most vehicles), connect the jump starter's POSITIVE (RED) clamp to the POSITIVE (POS, P, +) battery post. Next, connect the NEGATIVE (BLACK) clamp to the vehicle chassis or engine block, away from the battery.
4. For a positive-ground vehicle, connect the jump starter's NEGATIVE (BLACK) clamp to the NEGATIVE (NEG, N, -) battery post. Next, connect the POSITIVE (RED) clamp to the vehicle chassis or engine block away from the battery.
5. Press the  **Jump start** button to turn on the jump starter. The green **Ready** LED will light.
6. It is best to wait 30 seconds after clamp connection to attempt to start the vehicle. Crank for up to 5 seconds. If engine does not start, wait 30 seconds before cranking again.
7. After the engine starts, press the  **Jump start** button to turn the jump starter off, and then disconnect the black clamp (-) and the red clamp (+), in that order.
8. Recharge the unit as soon as possible after each use. **NOTE:** Recharge the unit when all **Battery Status** LEDs are off.

6.2 STARTING A BATTERY WITH LOW VOLTAGE

If the vehicle's battery voltage is too low for the jump starter to detect that the clamps are connected, there is a manual start procedure to enable the jump start function.

1. Make sure the clamps are correctly connected.
2. Press the  **Jump start** button. Next, press the  **Jump start** and the  **Light/USB Power** buttons. Hold both for 5 seconds to turn on the override mode. The green **Ready** LED will flash.



WARNING! This overrides a safety feature. It will energize the clamps and cause sparking if they are touched together. If the clamp connections are shorted or reversed, damage to the unit, battery and possibly the car's electrical system will occur.

6.3 USING THE USB PORT

The USB port provides up to 2.4A at 5V DC.

1. Ensure the battery clamps are securely clipped on the storage holders.
2. Press the  **Light/USB Power** button on the front of the unit to turn on the power.
3. Plug your device into the USB port.
4. Turn on the USB device, if necessary.
5. When finished using the USB port, turn off the device (if necessary) and unplug the device.
6. Recharge the unit as soon as possible after each use. **NOTE:** Recharge the unit when all **Battery Status** LEDs are off.



6.4 USING THE WORK LIGHT

1. Position the jump starter on a flat, stable surface near the intended work area.
2. Ensure the battery clamps are securely clipped on the storage holders.
3. Hold the  **Light/USB Power** button on the front of the unit for 0.75 second, to cycle through the following modes:
 - Steady glow
 - Flash for an SOS signal
 - Flash in strobe mode
4. When finished using the work light, press and hold the  **Light/USB Power** button for 0.75 second, to turn off the work light.
5. Recharge the unit as soon as possible after each use.

7. MAINTENANCE AND STORAGE

- 7.1 Clean the clips and the case each time you are finished using it.
- 7.2 Charge battery to full capacity before storage.
- 7.3 Store this unit at the temperatures between 14°F to 113°F (-10 °C to 45 °C).
- 7.4 Store clips on their support posts, to ensure they do not come into contact with any metallic surface.
- 7.5 Never completely discharge the internal battery.
- 7.6 Charge after each use.
- 7.7 Charge at least once every month, if not in frequent use, to prevent over-discharge.

8. TROUBLESHOOTING

PROBLEM	POSSIBLE CAUSE	SOLUTION
The jump starter won't jump start my car.	Clamps are not making a good connection to the battery.	Check for poor connection to battery and frame. Make sure connection points are clean.
	Connections are reversed.	Disconnect the jump starter and reverse the clamps.
	The jump starter's battery is not charged.	Press the  Light/USB Power button on the front of the unit. The LEDs will indicate the status of charge.
	The vehicle's battery is defective.	Have the battery checked.
	The jump starter is not turned on.	Press the  Jump start button to turn on the jump starter.
The jump starter will not operate.	The internal battery voltage is too low.	Use the USB adaptor to charge and activate.
The battery in the jump starter won't hold a charge.	The battery is bad (will not accept a charge).	Have the battery checked.

Ready/Fail LED Behavior

Green LED lit solid	Ready to jump start
Green LED flashing	Ready to override
Red LED lit solid and buzzer sounds continuously	Short circuit or reverse polarity protection
No LED lit and no buzzer beep	Battery exhausted
Red LED flashing and buzzer sounds every second	Temperature protection for unit

Battery Status LED Behavior

Four White LEDs flash at the same time.	Temperature protection for unit
---	---------------------------------

9. REPLACEMENT PARTS

USB charging cable	3899004188Z
12V DC car charger	2299002681Z
Carry bag	5899000044Z

10. SPECIFICATIONS

SL1596

Internal battery type	Lithium ion polymer
Battery Capacity	13400mAh
Cranking Current	2500A peak
USB input5V DC, 2A
USB output5V DC, 2.4A
12V DC input	12V DC, 1.5A
Charging temperature	32°F to 113°F (0 °C to 45 °C)
Discharging temperature	-4°F to 140°F (-20 °C to 60 °C)
Storage temperature	14°F to 113°F (-10 °C to 45 °C)

SL1610

Internal battery type	Lithium ion polymer
Battery Capacity	8000mAh
Cranking Current	1000A peak
USB input5V DC, 2A
USB output5V DC, 2.4A
12V DC input	12V DC, 1.5A
Charging temperature	32°F to 113°F (0 °C to 45 °C)
Discharging temperature	-4°F to 140°F (-20 °C to 60 °C)
Storage temperature	14°F to 113°F (-10 °C to 45 °C)

SL1611

Internal battery type	Lithium ion polymer
Battery Capacity	10000mAh
Cranking Current	1500A peak
USB input5V DC, 2A
USB output5V DC, 2.4A
12V DC input	12V DC, 1.5A
Charging temperature	32°F to 113°F (0 °C to 45 °C)
Discharging temperature	-4°F to 140°F (-20 °C to 60 °C)
Storage temperature	14°F to 113°F (-10 °C to 45 °C)

SL1612

Internal battery type	Lithium ion polymer
Battery Capacity	12000mAh
Cranking Current	2000A peak
USB input5V DC, 2A
USB output5V DC, 2.4A
12V DC input	12V DC, 1.5A
Charging temperature	32°F to 113°F (0 °C to 45 °C)
Discharging temperature	-4°F to 140°F (-20 °C to 60 °C)
Storage temperature	14°F to 113°F (-10 °C to 45 °C)

11. BEFORE RETURNING FOR REPAIRS

For REPAIRS OR RETURNS, visit 365rma.com
Visit schumacherelectric.com for Replacement Parts.

12. LIMITED WARRANTY

For information on our one-year limited warranty, please visit schumacherelectric.com or call 1-800-621-5485 to request a copy.
Go to schumacherelectric.com to register your product online.

