

CUSTOMER REFERENCE DRAWING

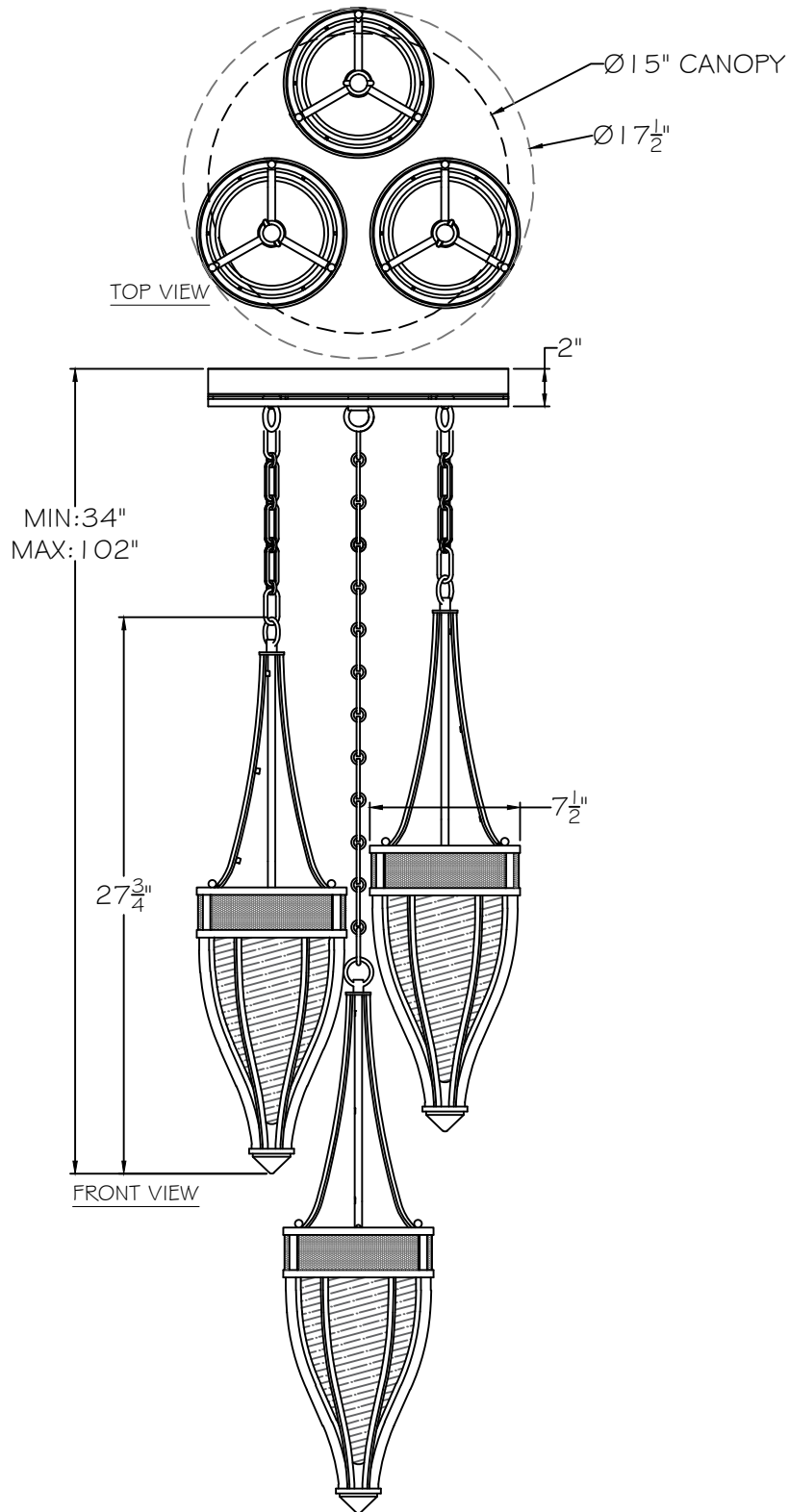

STYLE CONFIGURATIONS:

-1__ (BLCK IRON)	-2__ (BRONZE)	-3__ (GOLD LEAF)	-4__ (SILV. LEAF)	-5__ (SOFT GOLD)	-6__ (CHAMPGN)	-7__ (MID. STEEL)
-.1_ (SATIN BRSS)	-.2_ (SATIN NICKL)					
-. _ 1 (PEBBLE)	-. _ 2 (COCO)	-. _ 3 (BLK KGHT)				



This drawing, specifications and the product depicted are the exclusive property of Fine Art Handcrafted Lighting®. In compliance with US copyright and patent requirements, notice is hereby given that this document and the product depicted shall not be copied, altered or used in any manner without the expressed written consent of Fine Art Handcrafted Lighting®.

www.finearthl.com

Tel:(305) 821-3850
FINE ART LAMPS®

Fax:(305) 513-5736

STYLE NUMBER:

100044

DATE:

3/12/24