

Project Name _____
 Date _____ Part Number _____

PRODUCT

SKU	CLT-BR40-14W-L100-927
Item Number	CLT-30007
Lamp Shape	LED BR40

PRODUCT SPECIFICATION

Wattage	14	Voltage	120V
Lumens	1,000	Replacement Wattage	75W
CCT	2700K	Input Current (A)	-
Dimmable	Yes	Power Factor	> 0.9
Base	E26	CRI	90
Operating Temperature (°F)	-4° to 104°F		
IP Rating	Damp Location		
Rated Life	25,000 hrs		



DIMENSIONS

Diameter (in/mm)	4.72 / 120
Lamp Height (in/mm)	-
Height (in/mm)	6.26 / 259
Weight (lbs/oz)	0.26-lb / 4.16-oz

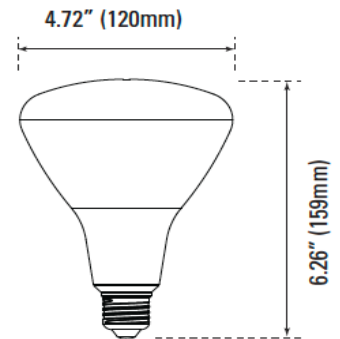

CERTIFICATIONS

DLC/ ENERGY STAR	-
UL/ETL	UL
RoHS	Yes
LM79/LM80	Yes
FCC	Yes

ACCESSORIES

APPLICATIONS

- Residential Lighting
- Decorative Lighting
- Retail Lighting
- Restaurant Lighting