

VASES COLLECTION

SKU:VOMOOD-701-VASES

Vases planter $\varnothing 65 \times 100$

Vases planter $\varnothing 55 \times 45$

Vases planter 130x55x45

Vases nano planter $\varnothing 14 \times 12$

Vases nano planter $\varnothing 18 \times 15$

Vases nano planter $\varnothing 14 \times 28$

Vases nano planter 14x33x12

Vases nano planter $\varnothing 18 \times 36$



VASES Collection, is made up of flowerpots, furniture and lighting designed by the Valencian designer JM Ferrero. It's shapes were inspired by diamond cutting, producing pieces of clear-cut shapes and great style, creating a big visual impact.

Info

Description

Pot made of polyethylene resin by rotational moulding. 100% Recyclable. Item suitable for indoor and outdoor use. Available in different finishes.

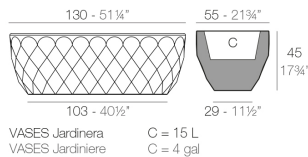
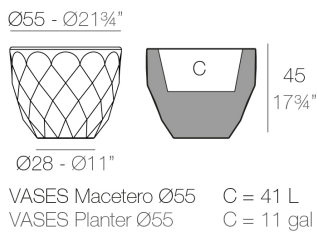
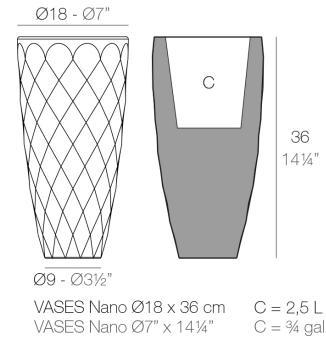
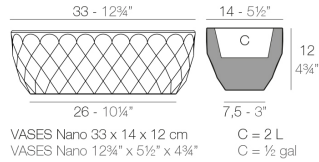
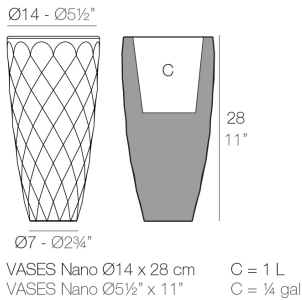
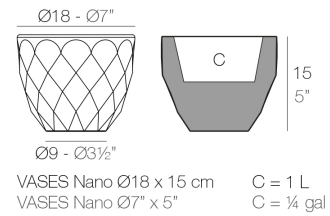
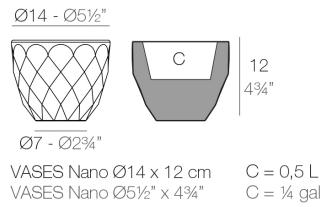
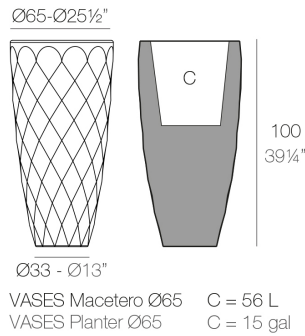

Vases island

by JM Ferrero

VASES Collection, is made up of flowerpots, furniture and lighting designed by the Valencian designer JM Ferrero. It's shapes were inspired by diamond cutting, producing pieces of clear-cut shapes and great style, creating a big visual impact.



Info

Description

Pot made of polyethylene resin by rotational moulding. 100% Recyclable. Item suitable for indoor and outdoor use. Available in different finishes.

Weight: 60 Kg

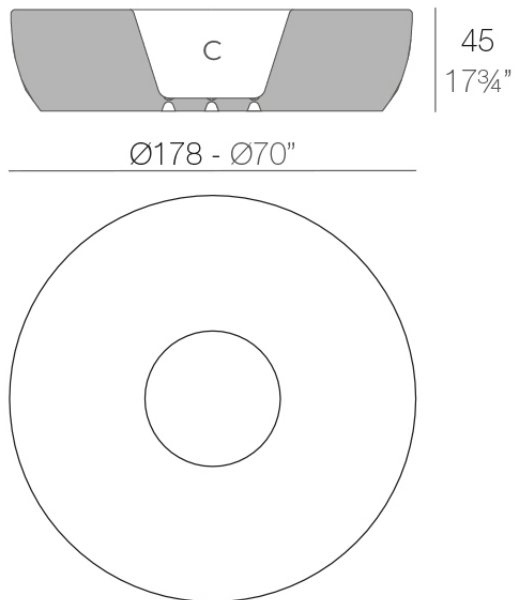

VASES Isla. Grosor Acollchado Isla: 4 cm.

C = Ø69 x 39 cm

VASES Island. Thick Cushion: 4 cm / 1 1/2"

C = Ø27 1/4" x 15 1/4"

Vases floor lamp $\varnothing 38 \times 70$

Vases floor lamp $\varnothing 56 \times 180$

Vases floor lamp $\varnothing 68 \times 220$

Vases lamps $\varnothing 30$

Vases lamps $\varnothing 40$

Vases lamps $\varnothing 60$

VASES Collection, is made up of flowerpots, furniture and lighting designed by the Valencian designer JM Ferrero. It's shapes were inspired by diamond cutting, producing pieces of clear-cut shapes and great style, creating a big visual impact.

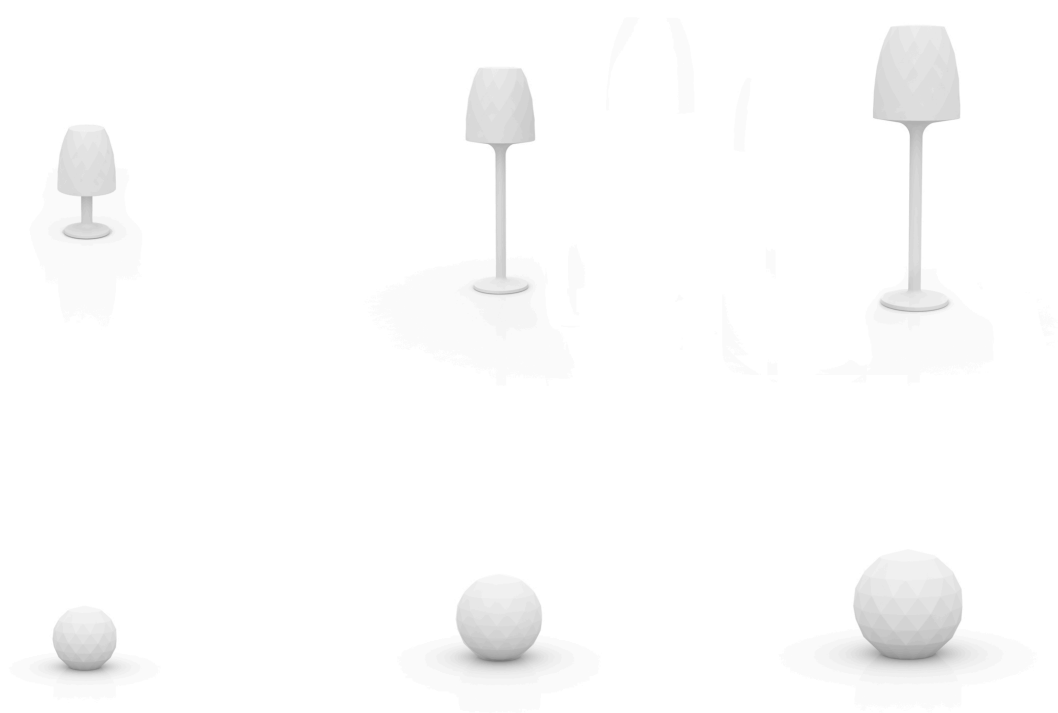

Info

Description

Made of polyethylene resin by rotational moulding. 100% Recyclable. Item suitable for indoor and outdoor use. Available in different finishes.

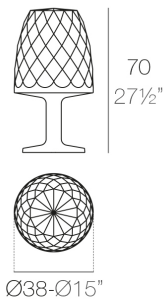

VASES Lámpara 70
VASES Lamp 70

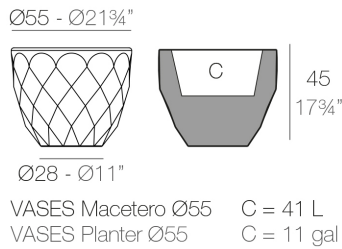

VASES Macetero Ø55 C = 41 L
VASES Planter Ø55 C = 11 gal

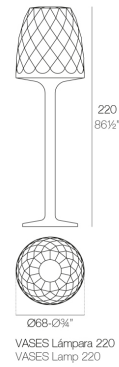

VASES Lámpara 220
VASES Lamp 220

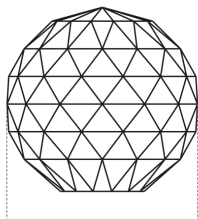

VASES Lámpara
VASES Lamp

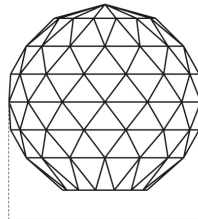

VASES Lámpara
VASES Lamp

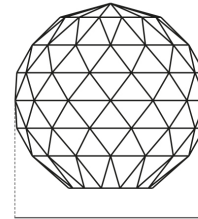

VASES Lámpara
VASES Lamp

Vases table ø60x74 - Vases table 60x60x74

Vases table ø70x74 - Vases table 70x70x74

Vases table 210x100x73

Vases table 100x100x73

VASES Collection, is made up of flowerpots, furniture and lighting designed by the Valencian designer JM Ferrero. It's shapes were inspired by diamond cutting, producing pieces of clear-cut shapes and great style, creating a big visual impact.



Info

Description

Made of polyethylene resin by rotational moulding. 100% Recyclable. Item suitable for indoor and outdoor use. Available in different finishes.

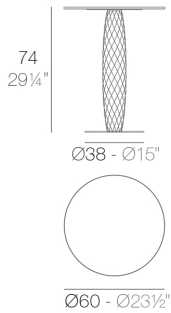

VASES Mesa Redonda Ø60
VASES Round Dining Table Ø23½"

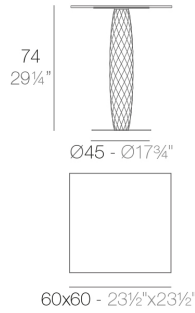

VASES Mesa Cuadrada 60x60
VASES Square Dining Table 23½"x23½"

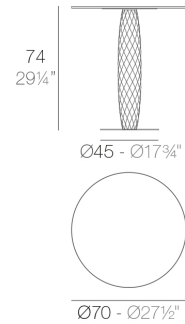

VASES Mesa Redonda Ø70
VASES Round Dining Table Ø27½"

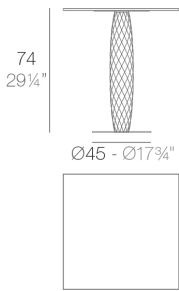

70x70 - 27½"x27½"
VASES Mesa Cuadrada 70x70
VASES Square Dining Table 27½"x27½"

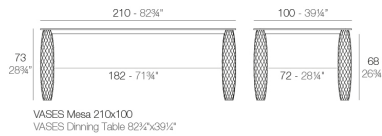

VASES Mesa 210x100
VASES Dining Table 82¾"x39¼"

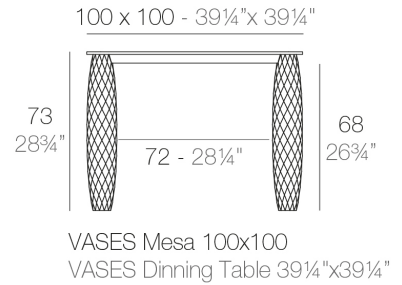

100 x 100 - 39¼"x 39¼"
VASES Mesa 100x100
VASES Dining Table 39¼"x39¼"

Vases armchair

VASES Collection, is made up of flowerpots, furniture and lighting designed by the Valencian designer JM Ferrero. It's shapes were inspired by diamond cutting, producing pieces of clear-cut shapes and great style, creating a big visual impact.



Info

Description

Injected polypropylene with fiber glass. The legs are made in powder coated stainless steel in a colour to match the seat.

Weight: 6.2 Kg

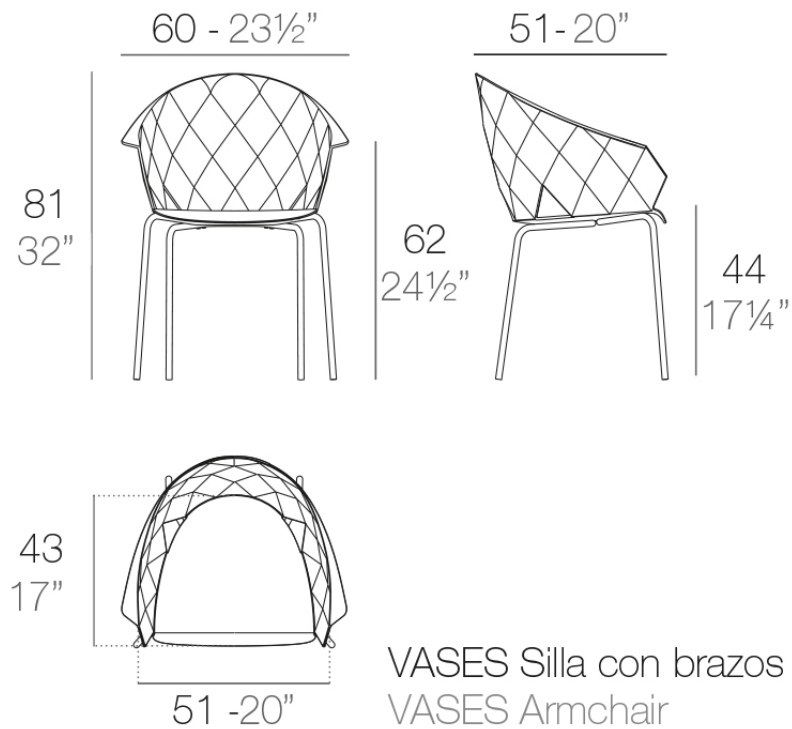

Vases bar stool

by JM Ferrero

VASES Collection, is made up of flowerpots, furniture and lighting designed by the Valencian designer JM Ferrero. It's shapes were inspired by diamond cutting, producing pieces of clear-cut shapes and great style, creating a big visual impact.



Info

Description

Injected polypropylene with fiber glass. The legs are made in powder coated stainless steel in a colour to match the seat.

Weight: 3.36 Kg

