

TABLET COLLECTION

SKU:VOMOOM-701-TABLET

Tablet sofa modular

The outdoor sofa Tablet collection, links new technologies and flexibility to the versatility of a sectional composition, creating a program based on the duality, identity and integration. Its character blends with the space and adapts itself to it.



Description

Modular type sofa, made from flexible polyurethane foam. Completely upholstered, with fabrics that are designed exclusively for outdoor use, but that still maintain the warmth and comfort of a fabric for indoor use.

These fabrics are available in a wide range of colours, which offer the possibility of creating completely unique, particular and comfortable spaces. This collection is suitable in and outdoors.

Modules

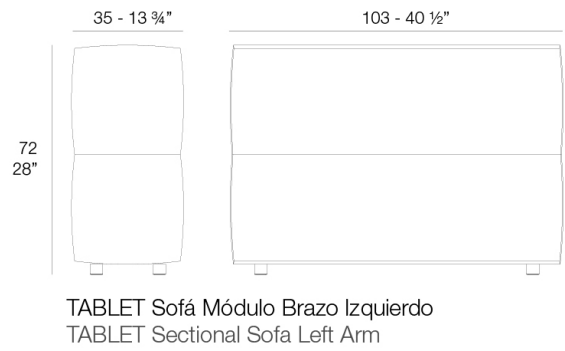
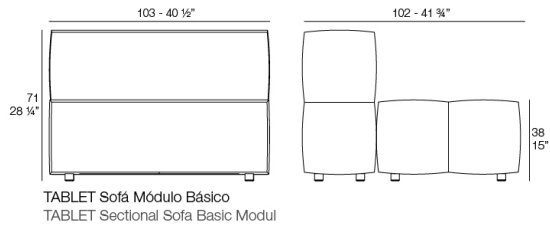
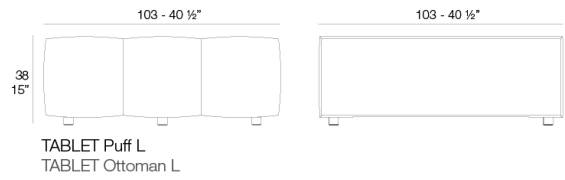
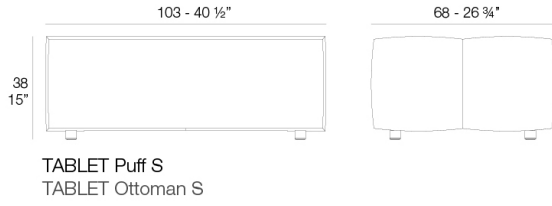

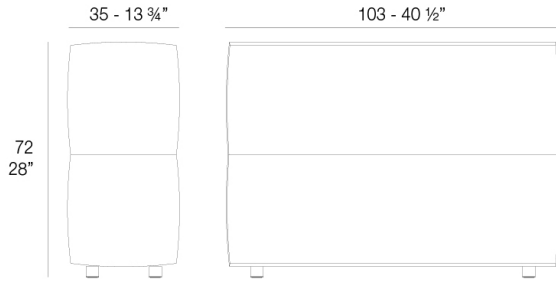

TABLET Sofá Módulo Brazo Derecho
TABLET Sectional Sofa Right Arm

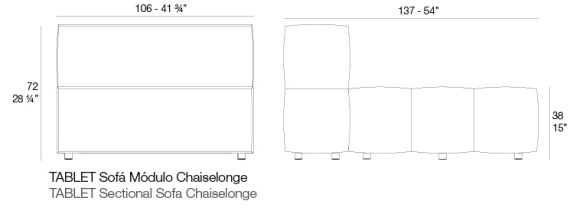

Combinations

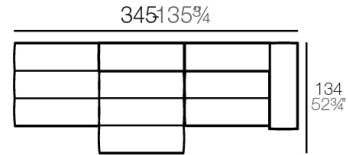
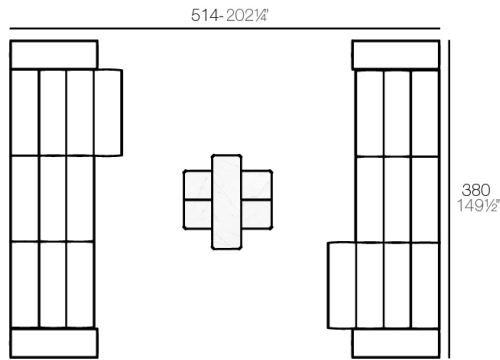

- 4 x 54214 Sofá Módulo Central - Sectional Sofa Armless
- 2 x 54226 Sofá Módulo Central Chaiselongue - Sectional Sofa Armless Chaiselongue
- 2 x 54224 Sofá Módulo Brazo Izquierdo - Sectional Sofa Left Arm
- 2 x 54225 Sofá Módulo Brazo Derecho - Sectional Sofa Right Arm
- 1 x 54219 Mesa Baja 1 - Coffee Table 1
- 1 x 54220 Mesa Baja 2 - Coffee Table 2

- 1 x 54214 Sofá Módulo Central - Sectional Sofa Armless
- 1 x 54226 Sofá Módulo Central Chaiselongue - Sectional Sofa Armless Chaiselongue
- 1 x 54224 Sofá Módulo Brazo Izquierdo - Sectional Sofa Left Arm
- 1 x 54213 Puff L - Ottoman L

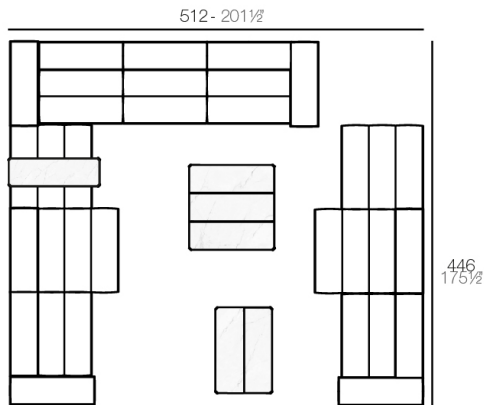

- 5 x 54214 Sofá Módulo Central - Sectional Sofa Armless
- 2 x 54226 Sofá Módulo Central Chaiselongue - Sectional Sofa Armless Chaiselongue
- 2 x 54224 Sofá Módulo Brazo Izquierdo - Sectional Sofa Left Arm
- 2 x 54225 Sofá Módulo Brazo Derecho - Sectional Sofa Right Arm
- 2 x 54213 Puff L - Ottoman L
- 1 x 54219 Mesa Baja 1 - Coffee Table 1
- 1 x 54220 Mesa Baja 2 - Coffee Table 2
- 1 x 54221 Mesa Baja 3 - Coffee Table 3

Tablet lounge chair

The outdoor sofa Tablet collection, links new technologies and flexibility to the versatility of a sectional composition, creating a program based on the duality, identity and integration. Its character blends with the space and adapts itself to it.



Description

Furniture made of flexible polyurethane injected cold. This material possesses a high resilience and durability.

The flexible polyurethane foam has an open cellular structure, it is a very elastic material. It hinders the growth of fungi and bacteria.

Weight: 42.76 Kg

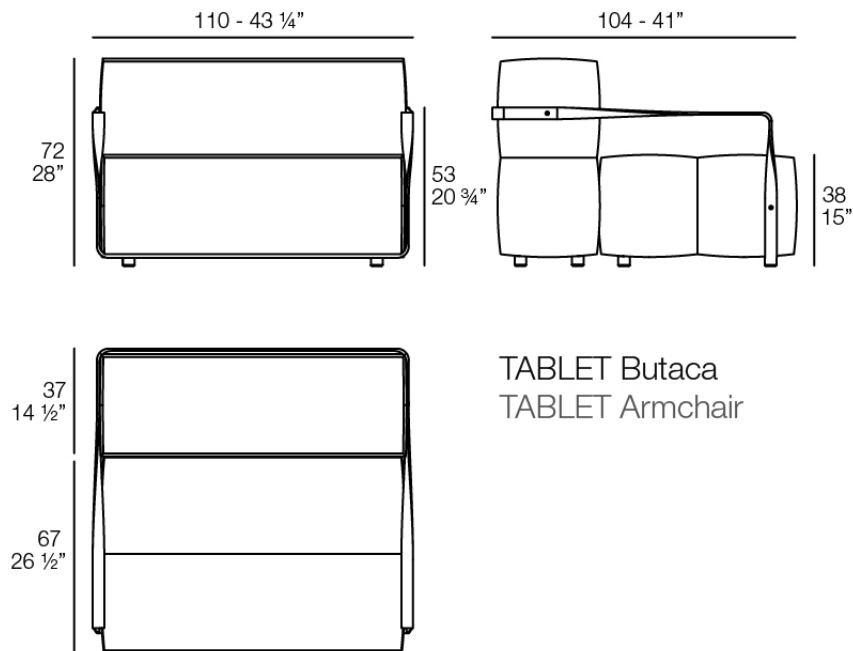

Tablet table 105x35x42cm



Description

Item suitable for indoor and outdoor use.

Weight: 14.77 Kg

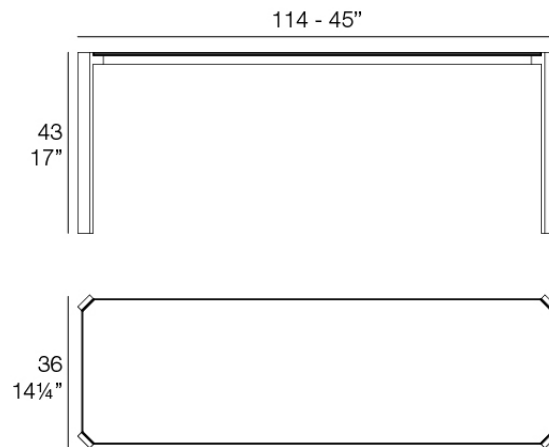

TABLET Mesa Baja 1
TABLET Low Table 1

Tablet table 105x70x40cm



Description

Item suitable for indoor and outdoor use.

Weight: 21.5 Kg

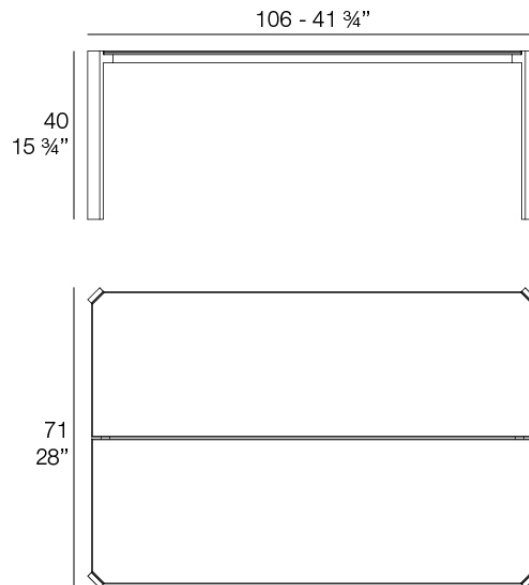

TABLET Mesa Baja 2
TABLET Low Table 2

Tablet mesa 105x105x40cm

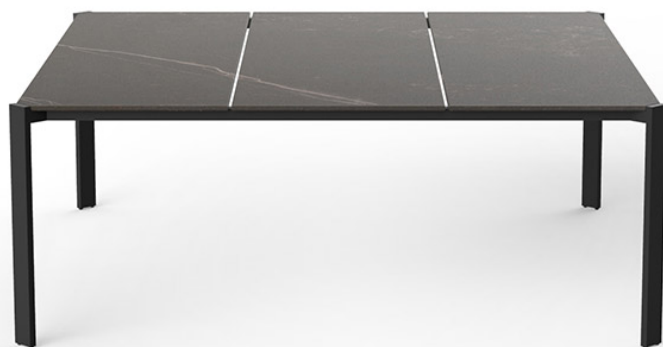

Description

Item suitable for indoor and outdoor use.

Weight: 28.51 Kg

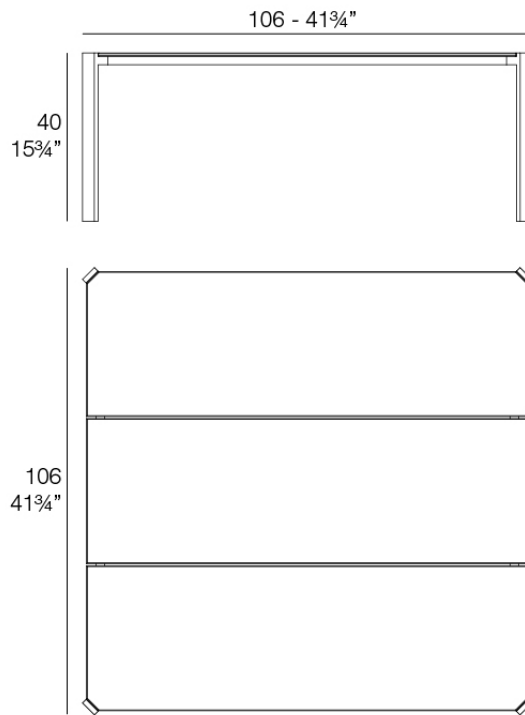

TABLET Mesa Baja 3
TABLET Low Table 3

Combinations

