



Table system is based on a technical minimalist leg solution that does not need a structure and can be attached directly to the table top.

Having no structure and a table top thickness of just 5 mm it acquires great visual lightness. There are endless uses, finishes and formats with this innovative system.

Its "one mile" concept expresses how it can be used for breakfast in the kitchen, then working in the office, for eating in its restaurant version and later on for a meeting around it as a boardroom table and finally for dinner in the evening.

VICTOR CARRASCO



Born in Valencia (Spain) in 1974, Victor Carrasco began his professional career after graduating Cum Laude in Industrial Design Engineering at the Polytechnic University of Valencia.

Shying away from trends and fads, he has developed and positioned international brands with remarkable added value, thanks to his passion for synthesis, sustainable growth and his pragmatic vision of the future.

Since 2007, he has been combining his position as strategic director of Viccarbe with that of Design Director for the prestigious American multinational Coalesse (Steelcase Inc.). Likewise, as an industrial designer, he has collaborated with numerous international companies such as Boffi, Glas Italia, Gandia Blasco, LZF, Vibia and Vaalva, among others.

He was the recipient of the Prince Felipe Award for Business Excellence in 2008.

DIMENSIONS

Different measures for the height of the table

SKU:VIMOB-601-MAA

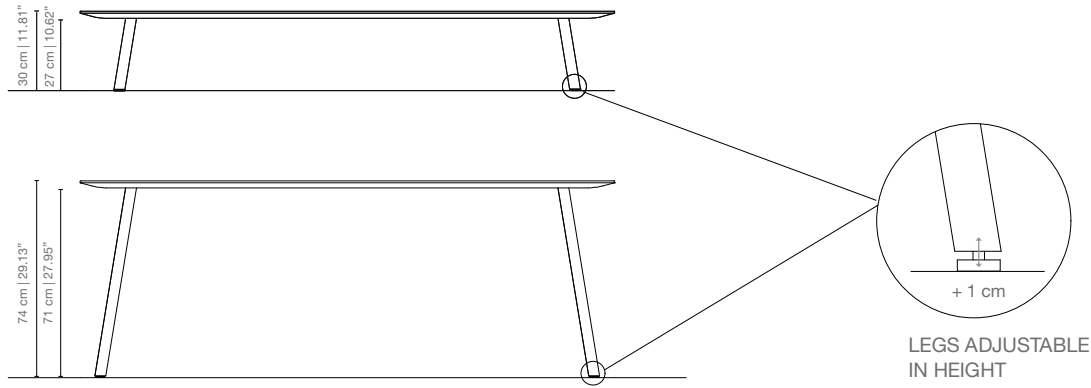

HEIGHT 30

MAAB8 80x80 table

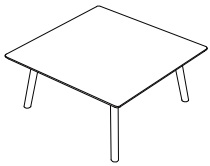

MAAB160 160x80 table

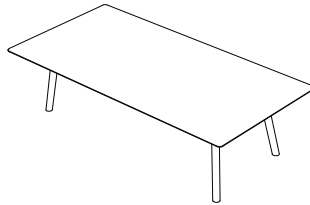

MAAB160_90 160x90 table

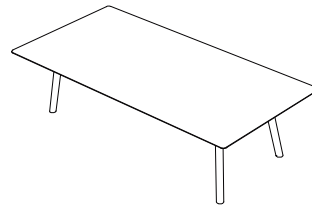

MAAB200_90 200x90 table

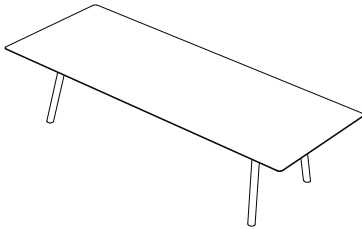

MAABD120 D120 table



MAAAD160 D160 table

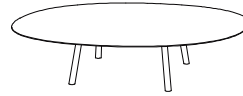

Note: The top is slightly oval-shaped

Note: The top is slightly oval-shaped

HEIGHT 74

MAA180 80x80 table

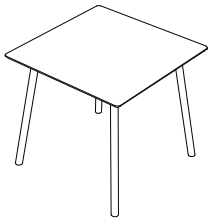

MAA160 160x80 table

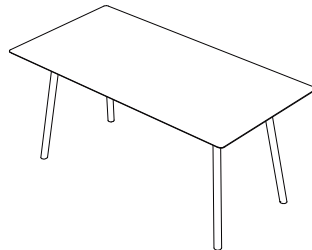

MAA160 160x90 table

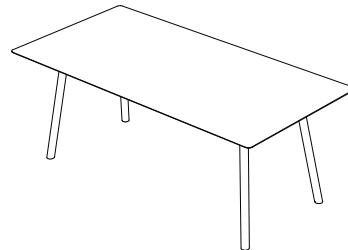

MAA180 180x80 table

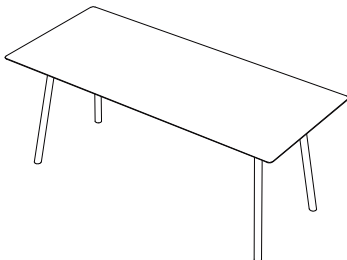

MAA180 180x90 table

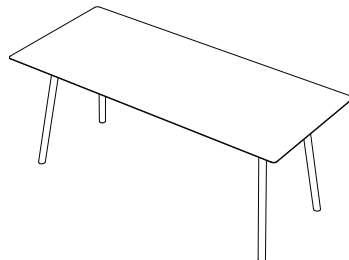

MAA200_90 200x90 table

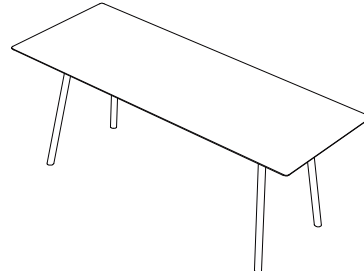

MAAD120 D120 table

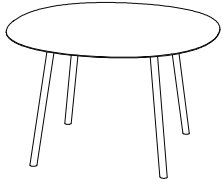

Note: The top is slightly oval-shaped

MAAD120 D120 table

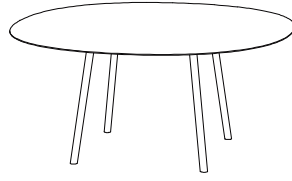

Note: The top is slightly oval-shaped

MAAA180 180x80 return table

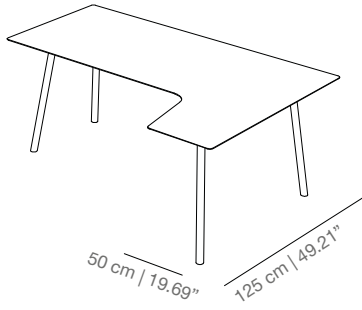

LEANED

MAA160A 160x80 leaned table

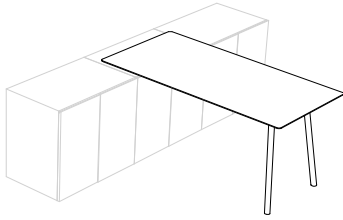

MAA180A 180x80 leaned table

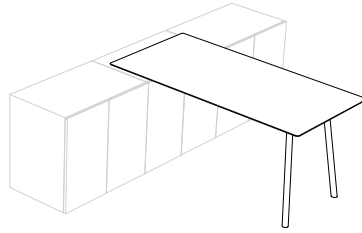

MAA200A 200x80 leaned table

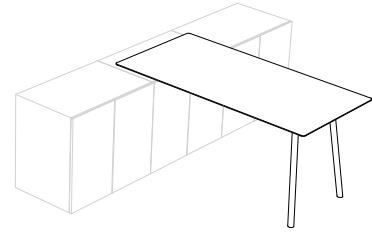

ACCESORIES

BUCS

CARB 2 drawers + filling cabinet

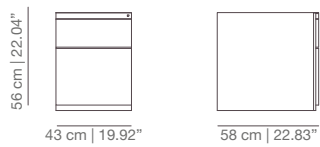

CAJB 3 drawers + filling cabinet

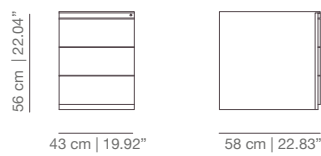

DOCPUP cabinet with door

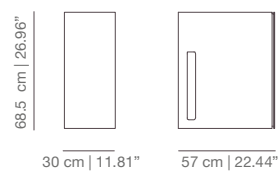

DO800PB 800 cabinet with doors

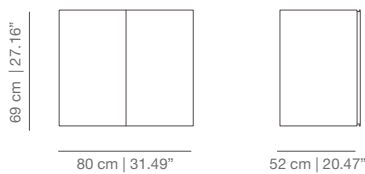

DO800B buc 800 + self

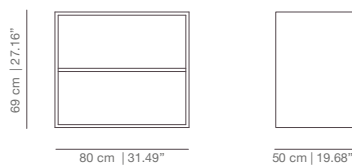

DO800DB storage unit 800 + dividers

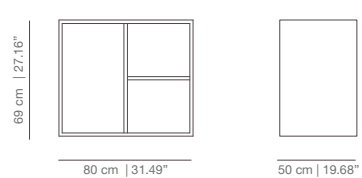

MAAF160 160 width modesty screen

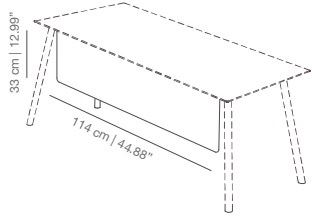

MAAF180 180-200 width modesty screen

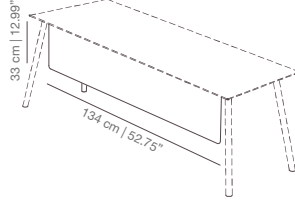

AC03B wirehole

Mechanizing of the board is included

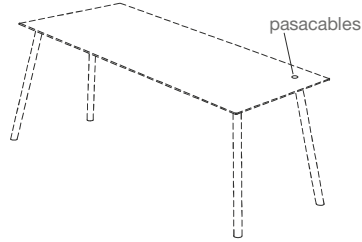

MAARMEC mechanized

Table top with Incision to measure

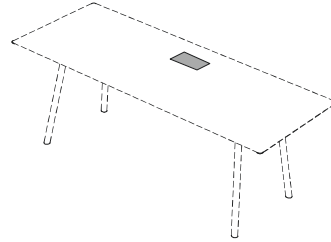

CAP rectangular conduit

Metallic access placket to the lower part of the table. Available in white, black or grey. Does not include electrifications.



CAPP rectangular conduit plus

Metal access placket to the lower part of the table, for wooden table tops. Metal frame available in black or grey and central part in the veneer of the finish of the table. Does not include electrifications.

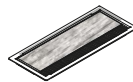

BOX power box for tabletop

Metal placket with 4 plugs or combined with integrated multimedia elements. Available in white, black or grey.

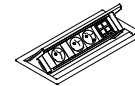

BOXP power box plus for tabletop

Metal placket with 4 plugs or combined with integrated multimedia elements, for wooden table tops. Metal frame available in black or grey and central part in the veneer of the finish of the table.



PROT - tabletop protector in eco leather

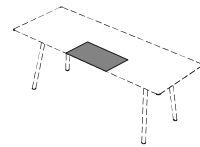

LES-WIRE wire holder for top

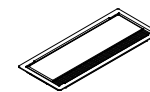

LEWIRES simple wire column
LEWIRED double wire column

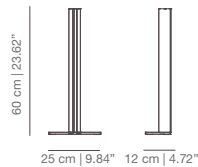
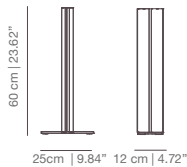

TECHNICAL INFO

Table top 30 mm thick manufactured in technical microtexturized MDF lacquered in the colours of our collection, or in plywood natural oak stained or lacquered. Complements manufactured in technical microtexturized MDF lacquered in the colors of our collection.

Legs in gauged steel thermoset lacquered or calibrated steel with an oak veneer, and adjustable in height available in all collection's polishes. Available the possibility of combining different colours of legs.

FINISHES

TOP

microtexturized MDF lacquered



white
RAL 9003



black
RAL 9005



grey
RAL 9006



sand
NCS 3005Y50R



tobacco
RAL 8028



smoke grey
NCS 4005Y20R



silver
RAL 9006



red
RAL 3001



mustard
RAL 1012



green
RAL 6007



blue
RAL 5024

stained



matt
oak



wenge



cognac



ash

LEGS

lacquered



white
RAL 9003



black
RAL 9005



altea blue
RAL 5000



sand
NCS 3005Y50R



flourescent orange
RAL 2005

CERTIFICATES

UNE EN 527-1:11

UNE EN 527-2-3:03





PROJECTS

L'Antic Colonial Showroom | AA Residence | Progetti