

## Cono Cuadrado Planter Collection

SKU: vomoom-701-Cono cuadrado

# Square cone pot 30x30x30

The most extensive collection of indoor and outdoor planters .Timeless and minimalist designs that allow you to create unique and original atmospheres for homes, restaurants and any space.



## Info

---

### Description

Pot made of polyethylene resin by rotational moulding. 100% Recyclable. Item suitable for indoor and outdoor use. Available in different finishes.

Weight: 1.7 Kg

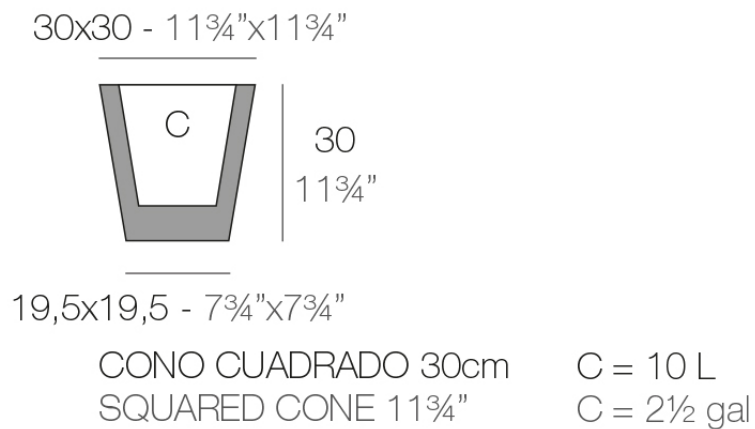

## Square cone pot 40x40x40

The most extensive collection of indoor and outdoor planters .Timeless and minimalist designs that allow you to create unique and original atmospheres for homes, restaurants and any space.



## Info

---

### Description

Pot made of polyethylene resin by rotational moulding. 100% Recyclable. Item suitable for indoor and outdoor use. Available in different finishes.

Weight: 3.2 Kg

40x40 - 15¾"x15¾"

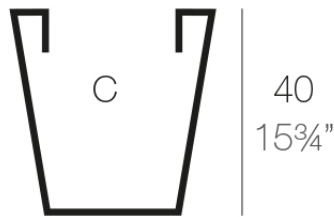

26x26 - 10¼"x10¼"

CONO CUADRADO 40cm  
SQUARED CONE 15¾"

C = 44 L  
C = 11½ gal

## Square cone pot 50x50x50

The most extensive collection of indoor and outdoor planters .Timeless and minimalist designs that allow you to create unique and original atmospheres for homes, restaurants and any space.



## Info

---

### Description

Pot made of polyethylene resin by rotational moulding. 100% Recyclable. Item suitable for indoor and outdoor use. Available in different finishes.

Weight: 5.5 Kg

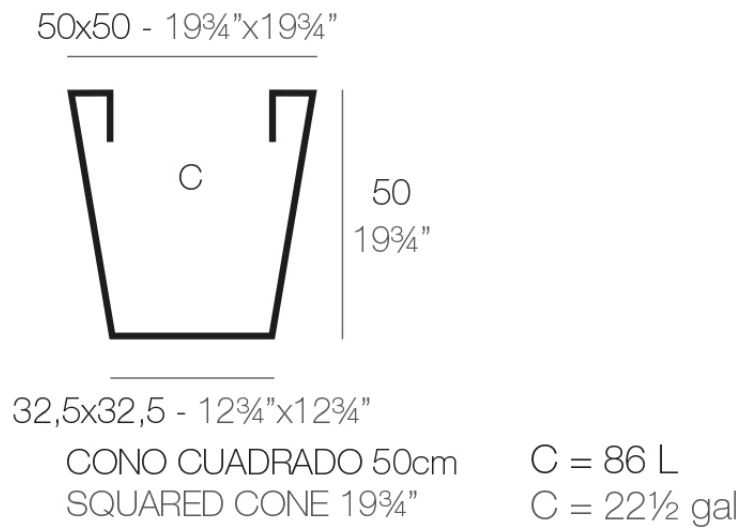

## Square cone pot 60x60x60

The most extensive collection of indoor and outdoor planters .Timeless and minimalist designs that allow you to create unique and original atmospheres for homes, restaurants and any space.



## Info

---

### Description

Pot made of polyethylene resin by rotational moulding. 100% Recyclable. Item suitable for indoor and outdoor use. Available in different finishes.

Weight: 8.4 Kg

60x60 - 23½"x23½"

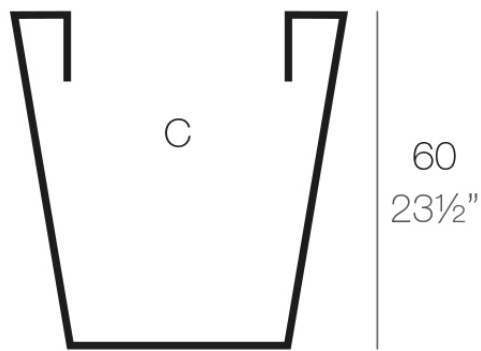

39x39 - 15¼"x15¼"

CONO CUADRADO 60cm  
SQUARED CONE 23½"

C = 150 L  
C = 39½ gal



## Square cone pot 80x80x80

The most extensive collection of indoor and outdoor planters .Timeless and minimalist designs that allow you to create unique and original atmospheres for homes, restaurants and any space.



## Info

---

### Description

Pot made of polyethylene resin by rotational moulding. 100% Recyclable. Item suitable for indoor and outdoor use. Available in different finishes.

Weight: 18 Kg

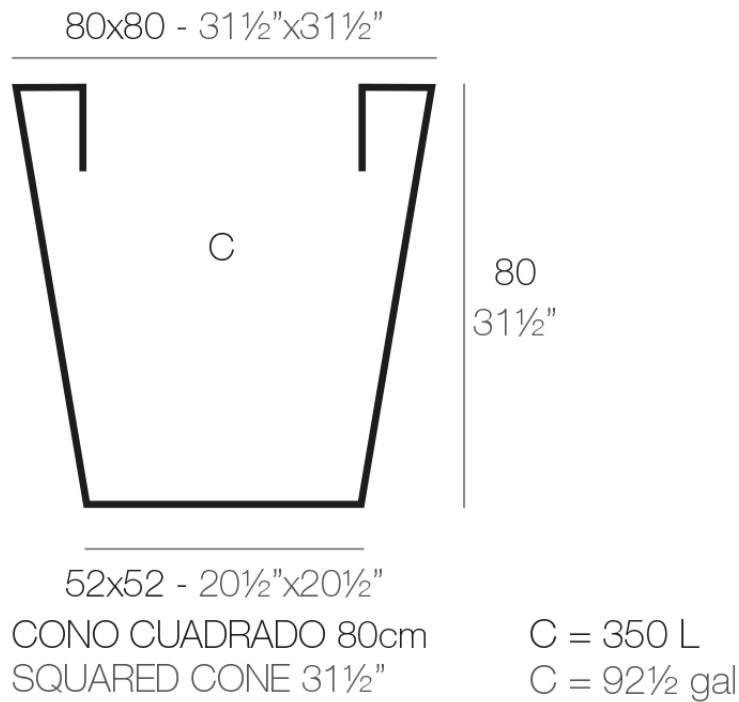

# High square cone 10x10x20

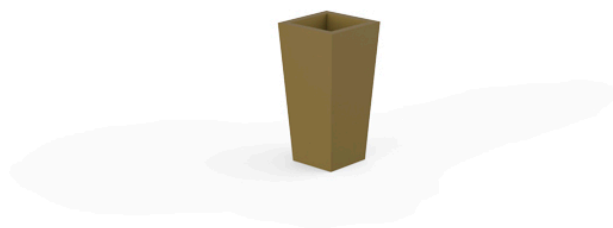

## Info

---

### Description

Pot made of polyethylene resin by rotational moulding. 100% Recyclable. Item suitable for indoor and outdoor use. Available in different finishes.

Weight: 0.3 Kg

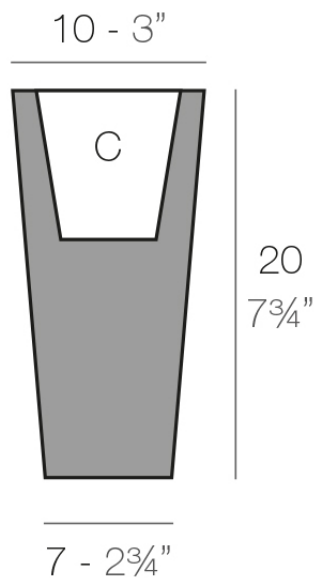

CONO ALTO Nano 10 cm  
HIGH CONE Nano 3"

C = 0,5 L  
C = 1/4 gal

# High square cone 14x14x28



## Info

---

### Description

Pot made of polyethylene resin by rotational moulding. 100% Recyclable. Item suitable for indoor and outdoor use. Available in different finishes.

Weight: 0.7 Kg

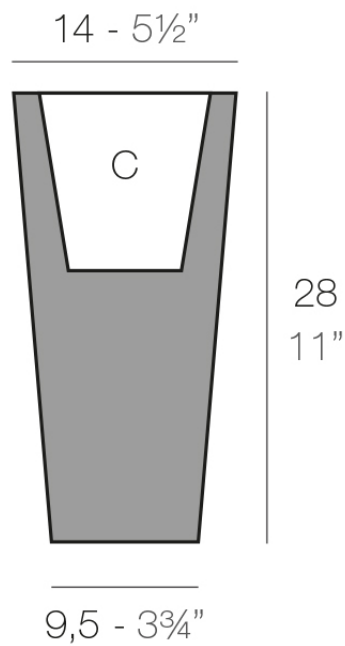

CONO ALTO Nano 14 cm  
HIGH CONE Nano 5 1/2"

C = 1,5 L  
C = 1/2 gal

# High square cone 18x18x36

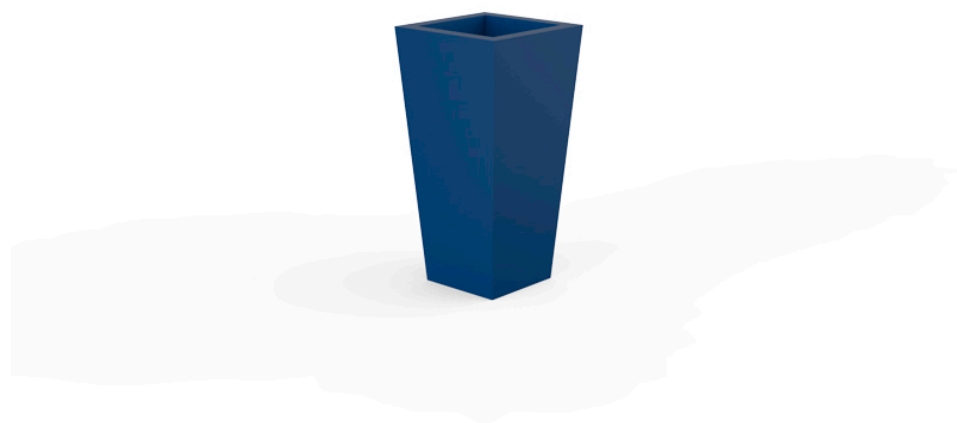

## Info

---

### Description

Pot made of polyethylene resin by rotational moulding. 100% Recyclable. Item suitable for indoor and outdoor use. Available in different finishes.

Weight: 1.4 Kg

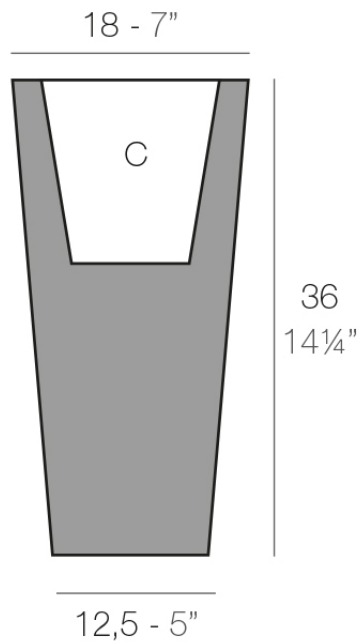

CONO ALTO Nano 18 cm  
HIGH CONE Nano 7"

C = 3 L  
C = 1 gal



# High square cone pot 35x35x100

The most extensive collection of indoor and outdoor planters .Timeless and minimalist designs that allow you to create unique and original atmospheres for homes, restaurants and any space.

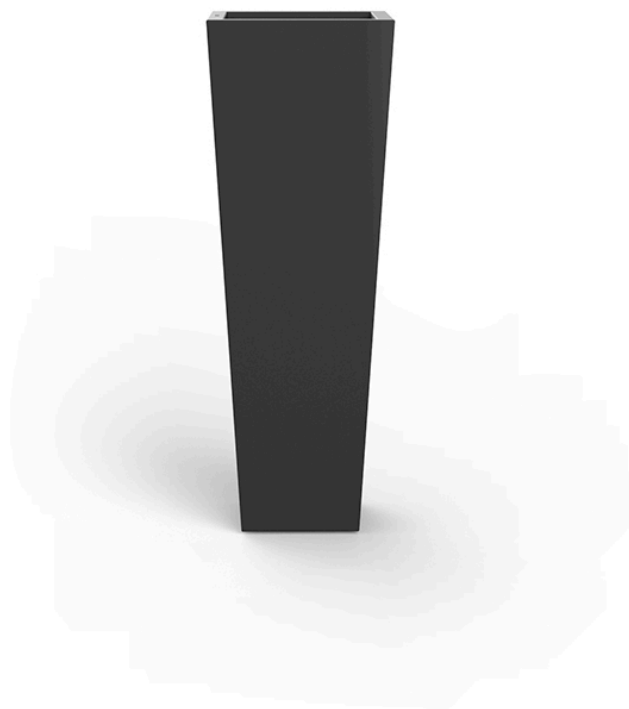

## Info

---

### Description

Pot made of polyethylene resin by rotational moulding. 100% Recyclable. Item suitable for indoor and outdoor use. Available in different finishes.

Weight: 7 Kg

35x35- 13 $\frac{3}{4}$ "x13 $\frac{3}{4}$ "

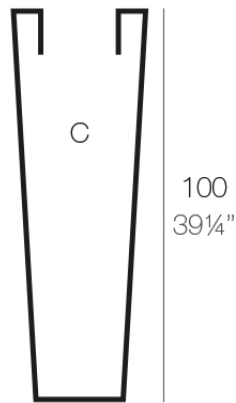

23x23 - 9"x9"

CONO CUADRADO ALTO 35 x 100 cm  
HIGH SQUARE CONE 13 $\frac{3}{4}$ " x 39 $\frac{1}{4}$ "

C = 86 L  
C = 22 $\frac{1}{2}$  gal

## High square cone pot 40x40x52

The most extensive collection of indoor and outdoor planters .Timeless and minimalist designs that allow you to create unique and original atmospheres for homes, restaurants and any space.



## Info

---

### Description

Pot made of polyethylene resin by rotational moulding. 100% Recyclable. Item suitable for indoor and outdoor use. Available in different finishes.

Weight: 1.85 Kg

40x40- 15¾"x15¾"

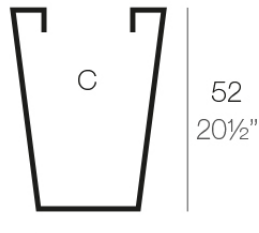

25,5x25,5 - 10"x10"

CONO CUADRADO ALTO 40 x 52 cm  
HIGH SQUARE CONE 15¾" x 20½"

C = 55 L  
C = 14½ gal

## High square cone pot 45x45x68

The most extensive collection of indoor and outdoor planters .Timeless and minimalist designs that allow you to create unique and original atmospheres for homes, restaurants and any space.



## Info

---

### Description

Pot made of polyethylene resin by rotational moulding. 100% Recyclable. Item suitable for indoor and outdoor use. Available in different finishes.

Weight: 7.02 Kg

45x45 - 17<sup>3</sup>/<sub>4</sub>"x17<sup>3</sup>/<sub>4</sub>"

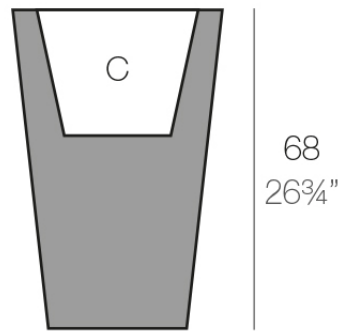

27x27 - 10<sup>3</sup>/<sub>4</sub>"x10<sup>3</sup>/<sub>4</sub>"

CONO CUADRADO ALTO 45 cm  
SQUARE HIGH CONE 17<sup>3</sup>/<sub>4</sub>"

C = 32 L  
C = 8<sup>1</sup>/<sub>2</sub> gal

## High square cone pot 50x50x65

The most extensive collection of indoor and outdoor planters .Timeless and minimalist designs that allow you to create unique and original atmospheres for homes, restaurants and any space.



## Info

---

### Description

Pot made of polyethylene resin by rotational moulding. 100% Recyclable. Item suitable for indoor and outdoor use. Available in different finishes.

Weight: 3.3 Kg

50x50- 19 $\frac{3}{4}$ "x19 $\frac{3}{4}$ "

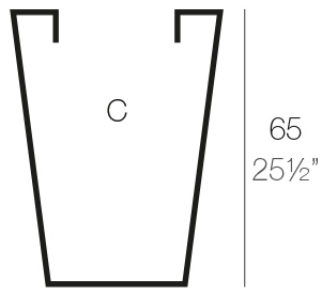

32x32 - 12 $\frac{1}{2}$ "x12 $\frac{1}{2}$ "

CONO CUADRADO ALTO 50 x 65 cm  
HIGH SQUARE CONE 19 $\frac{3}{4}$ " x 25 $\frac{1}{2}$ "

C = 110 L  
C = 29 gal



## High square cone pot 55x55x100

The most extensive collection of indoor and outdoor planters .Timeless and minimalist designs that allow you to create unique and original atmospheres for homes, restaurants and any space.

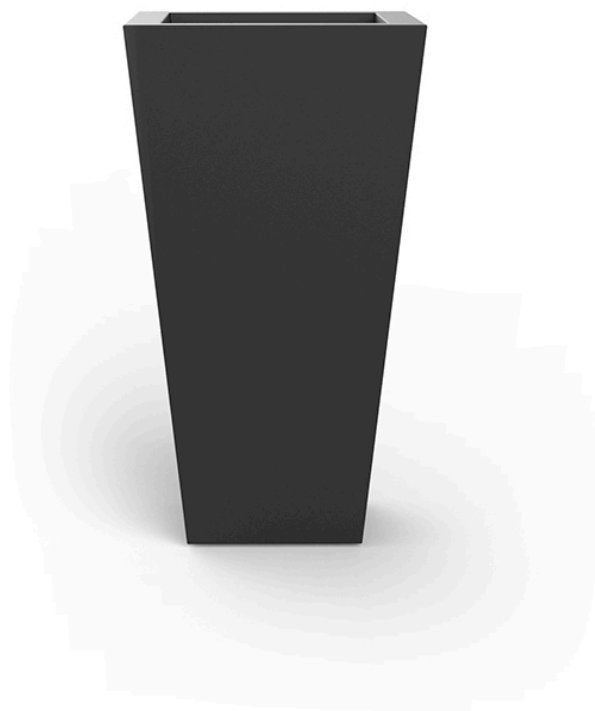

## Info

---

### Description

Pot made of polyethylene resin by rotational moulding. 100% Recyclable. Item suitable for indoor and outdoor use. Available in different finishes.

Weight: 10.5 Kg

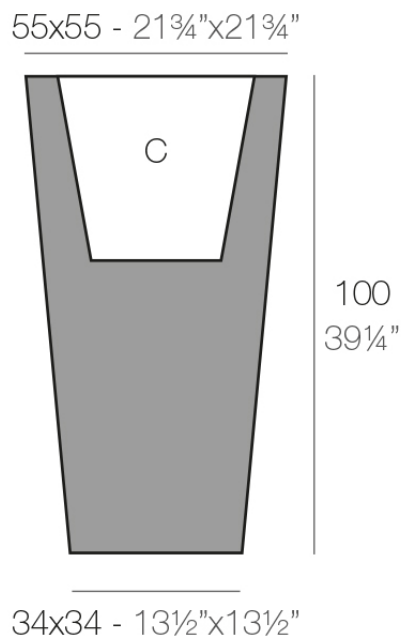

CONO CUADRADO ALTO 55 cm  
SQUARE HIGH CONE 21<sup>3</sup>/<sub>4</sub>"

C = 60 L  
C = 15<sup>3</sup>/<sub>4</sub> gal

## High square cone pot 60x60x78

The most extensive collection of indoor and outdoor planters .Timeless and minimalist designs that allow you to create unique and original atmospheres for homes, restaurants and any space.



## Info

---

### Description

Pot made of polyethylene resin by rotational moulding. 100% Recyclable. Item suitable for indoor and outdoor use. Available in different finishes.

Weight: 5.25 Kg

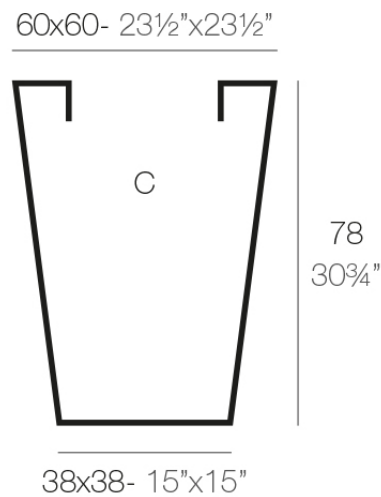

CONO CUADRADO ALTO 60 x 78 cm  
HIGH SQUARE CONE 23½" x 30¾"

C = 190 L  
C = 50 gal