

Burin table



Burin double base H74 L240 cm / H29.13" L94.48"
with powerbox
SKU:VIMOB-601-BUC240



Burin double base H74 1240 cm / H29.13" L94.48"
SKU:VIMOB-601-BUC300



Burin central base H 74 D150 cm / H29.13" D59.05"
with pop-up sockets
SKU:VIMOB-601-BUD120



Burin triple base H74 1350 cm / H29.13" L889"
with pop-up sockets
SKU:VIMOB-601-BUC500

Connectivity



1. Pop-up sockets
2. USB port
3. Powerbox
4. Pop-up sockets

The rules of the game are broken. The boundaries between spaces are blurred. What in the past we were used to understand as work spaces, today have become friendly living rooms or quiet libraries.

The reference boutique hotels and cafes want to be co-working spaces. Households prepare for co-living. And—above all—they take values such as flexibility for granted.

But in all these spaces, in all these places for people, there is a value sine qua non to the condition of the human being. In all of them there is the search for well-being, self-realization and freedom of expression. In all of them, one expects to experience the feeling of comfort. There is therefore a fine line between

the ambition to achieve iconic design and functional design at the same time, a line between the personality of the author and the role that a table should play in a collective or private space.

With Patricia Urquiola, we learned to look for new ways of constructing, to make use of materials that the classic furniture industry would not have contemplated. We also learned to project a continuity within the collection. In Burin's case, it would happen at the time when we were expanding an existing family, but also with the use of rotational polyethylene in the manufacture of its base. The moment when we opened the doors to this material comes to mind: 2006 gave us the Last Minute stool and its seat in this same rotomolded polyethylene.

HEIGHT 74 | 29¹³/₄"

BUD60_
table round 60 | 23⁵/₈"

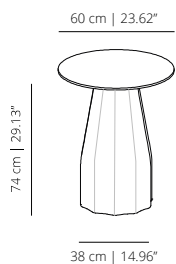

BUD70_
table round 70 | 27⁶/₄"

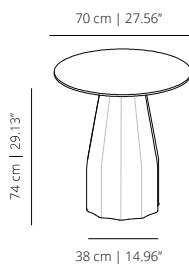

HEIGHT 74 | 29¹³/₄"

BUD80_
table round 80 | 31¹/₂"

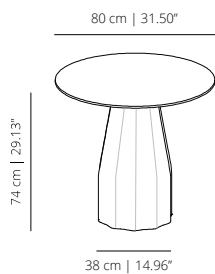

BUD100_
table round 100 | 39³/₈"

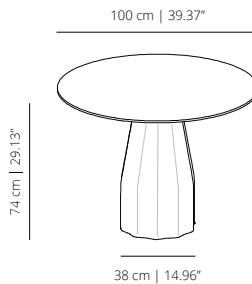

HEIGHT 74 | 29¹³/₄"

BUD120_
table round 120 | 47¹/₄"

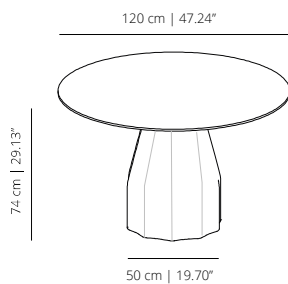

BUD150_
table round 150 | 59¹/₁₆"

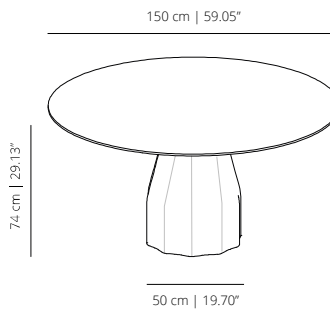

HEIGHT 74 | 29⁹/₆₄"

BUC70_

table 70x70 | 27⁶¹/₆₄ x 27⁶¹/₆₄

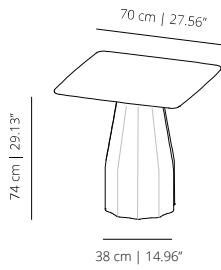

BUC80_

table 80x80 | 31¹/₂ x 31¹/₂

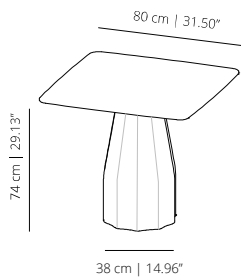

HEIGHT 74 | 29⁹/₆₄"

BUC90_

table 90x90 | 35⁷/₁₆ x 35⁷/₁₆

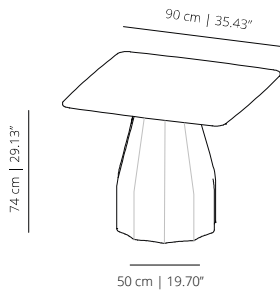

BUC100_

table 100x100 | 39.37" x 39.37"

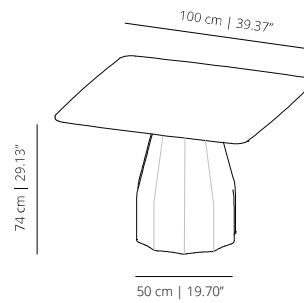

HEIGHT 74 | 29⁹/₆₄"

BUC240_

table 240x120 | 94¹/₂ x 47¹/₄

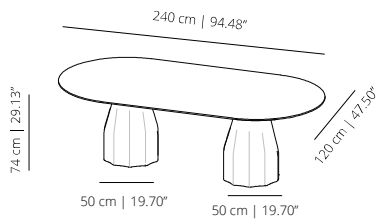

BUC300_

table 240x120 | 118⁷/₆₄ x 59¹/₁₆

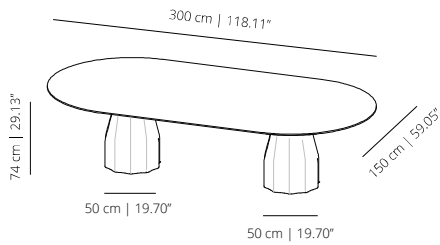

HEIGHT 74 | 29⁹/₁₆

BUC500_
table 500x150 | 196²⁷/₃₂ x 59¹/₁₆

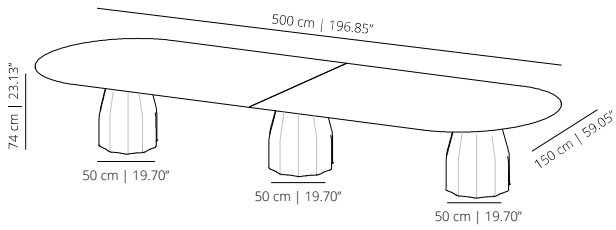

HEIGHT 102 | 40³/₁₆

BUD60H_
table round 60 | 23⁵/₈

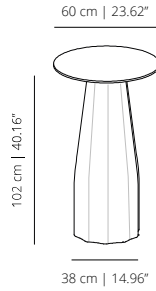

HEIGHT 102 | 40³/₁₆

BUD70H_
table round 70 | 27⁶/₁₆

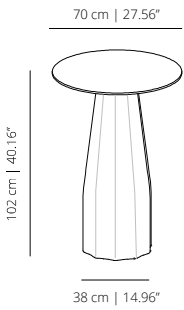

BUD80H_
table round 80 | 31¹/₂

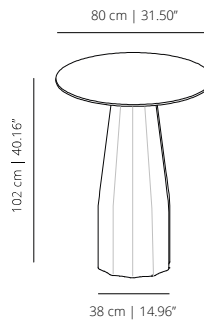

HEIGHT 102 | 40³/₁₆

BUD100H_
table round 100 | 39³/₈

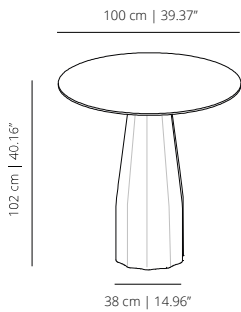

BUC70H_
table 70x70 | 27⁶/₁₆ x 27⁶/₁₆

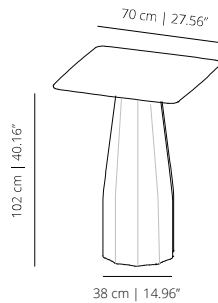

HEIGHT 102 | 40³/₁₆

BUC80H_
table 80x80 | 31¹/₂ x 31¹/₂

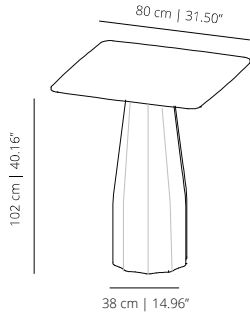

SEATING CAPACITY

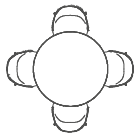

Up to 4
D60 - D100 cm | D23.6" - D39.4"

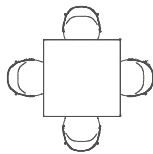

Up to 4
70x70 - 100x100 cm | 27.6x27.6" - 39.4x39.4"

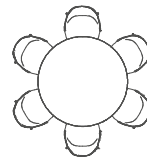

Up to 6
D120 cm | D47.24"

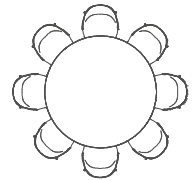

Up to 8
D150 cm | D59"

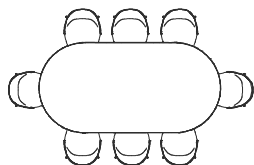

Up to 8
240x120 cm | 94.5x47.24"

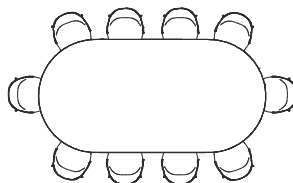

Up to 10
300x150 cm | 118.1x59.1"

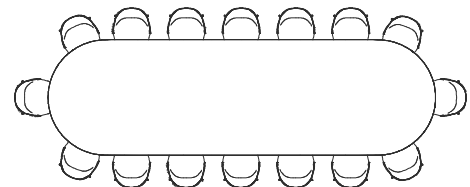

Up to 16
500x150 cm | 196.85x59.1"

**Seats calculated using Aleta chair, might differ when choosing other models*

TABLETOPS MATERIALS

MDF - STAINED & LACQUERED

The 30 mm thick cover or work surface is made with microtextured MDF. It is lacquered with one of our collection's finishes. It also comes with a solid oak veneer, stained in mate, cognac or ash. Available in high resistance materials such as HPL with MDF for heavy contract use.

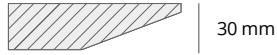

30 mm



bleached stained oak



matt stained oak



cognac stained oak



walnut stained oak



ash stained oak



white
RAL 9003



black
RAL 9005



taupe
RAL 1019



dusty green
RAL 7034



olive green
RAL 0904030



brick
RAL 0505030



dusty pink
RAL 0607020

HPL WITH MDF

High pressure HPL laminate in black or white on a 30 mm thick MDF board with stained edges in transparent.

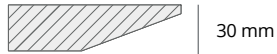

30 mm

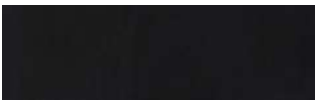

black | soft touch by FENIX®



white

MELAMINE

Melamine (LPL) thickness 19 mm with 1,5 mm PVC edge, in black or white.



19 mm



black



white

COMPACT

12 mm thick compact laminated table top. The edge can be in black or white. With a black edge, the surface of the tabletop can be black or white; for a white edge, it can be white.



12 mm



black



white

BASE OPTIONS

Central support available in roto-moulded polyethylene in white, black or taupe.

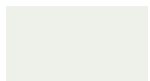

white
RAL 9003



black
RAL 9005



taupe
RAL 1019

Heights and types of bases available:

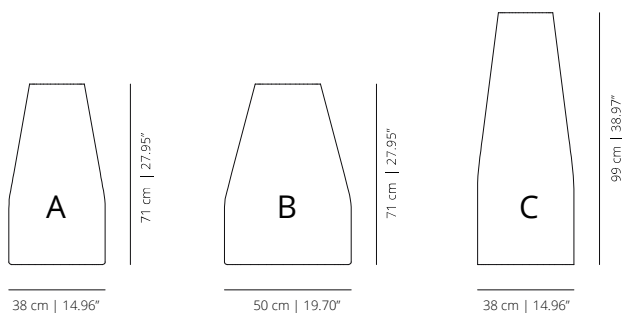

Range of tops for base A: D60 - D100 | 60x60 - 80x80
D23.62" - D39.37" | 23.62"x23.62" - 31.49"x 31.49"

Range of tops for base B: D120 - D150 | 90x90 - 100x100 - 140x140
D47.24" - D59.05" | 39.37"x39.37" - 55.11"x55.11"

Range of tops for base C: D60 - D100 | 70x70 - 80x80
D23.62" - D39.37" | 27.55"x27.55" - 31.49"x 31.49"

Different electrification options:

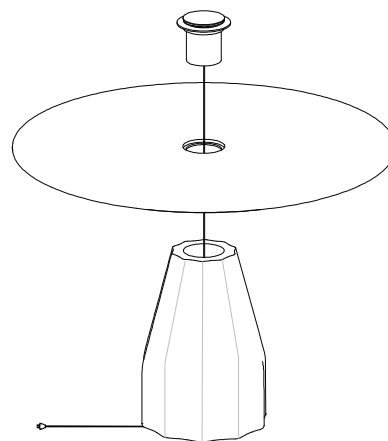

OUTDOOR FINISHES

TABLETOPS MATERIALS

COMPACT

12 mm thick compact laminated table top. The edge can be in black or white. With a black edge, the surface of the tabletop can be black or white; for a white edge, it can be white.



black



white

BASE OPTIONS

Central support available in roto-moulded polyethylene in white, black or taupe.



white
RAL 9003



black
RAL 9005



taupe
RAL 1019

NOTE: Outdoor cover available to protect the product from water, humidity and sunlight.

ACCESSORIES & ELECTRIFICATIONS



Cut out. Table top custom cut out.



Table top hatch. Metallic hatch access to the lower part of the table. Available in white, black or grey. Does not include power options. Dimensions: 32x15 cm | 12.59"x5.90".



Table top hatch plus. Metallic hatch access to the lower part of the table for wooden table tops. Metal frame available in black or grey and central part in the veneer of the finish of the table. Does not include power options. Dimensions: 32x15 cm | 12.59"x5.90"



Table top hatch powerbox. Metallic hatch with 4 sockets or combined with built-in multimedia devices. Available in white, black or grey. Dimensions: 32x15 cm | 12.59"x5.90"



Power box for table top plus. Metallic hatch with 4 sockets or combined with built-in multimedia devices. Available in white, black or grey. Dimensions: 32x15 cm | 12.59"x5.90"



USB hub with battery. USB hub with two USB device charging ports without being plugged into electric current. It's needed to buy the battery charging tray to charge the USB hub battery.



USB port. Built-in USB hub for charging electronic devices. Available in black or white. Dimensions: Ø 3 cm | 1.18"



Under table powerbox. Powerbox available with 2 sockets or combined with built-in multimedia devices.



Pop-up sockets. Built-in pop-up socket cylinder made of stainless steel can have 2 Schuko sockets or 1 Schuko socket + 2 USB hubs. For different configurations, contact the sales department. The cylinder is hidden and pops up by gently pressing on it, offering the possibility of connection on four sides.