

Detroit Speed
C2/C3 IRS DECAlink
1963-82 Corvette
P/N: 041740DS - 041745DS

The Detroit Speed Corvette IRS DECAlink rear suspension features Detroit Speed's exclusive no-compromise suspension geometry for superior handling and ride quality. All suspension link lengths are adjustable and have adjustments for rear anti-squat geometry and roll center height. It utilizes modern CV axle shafts and hub bearings so that suspension loads are no longer transmitted to the axle shafts. The two-piece aluminum/steel cradle assembly allows for easy differential housing removal. The suspension is offset inboard to allow for additional tire clearance.

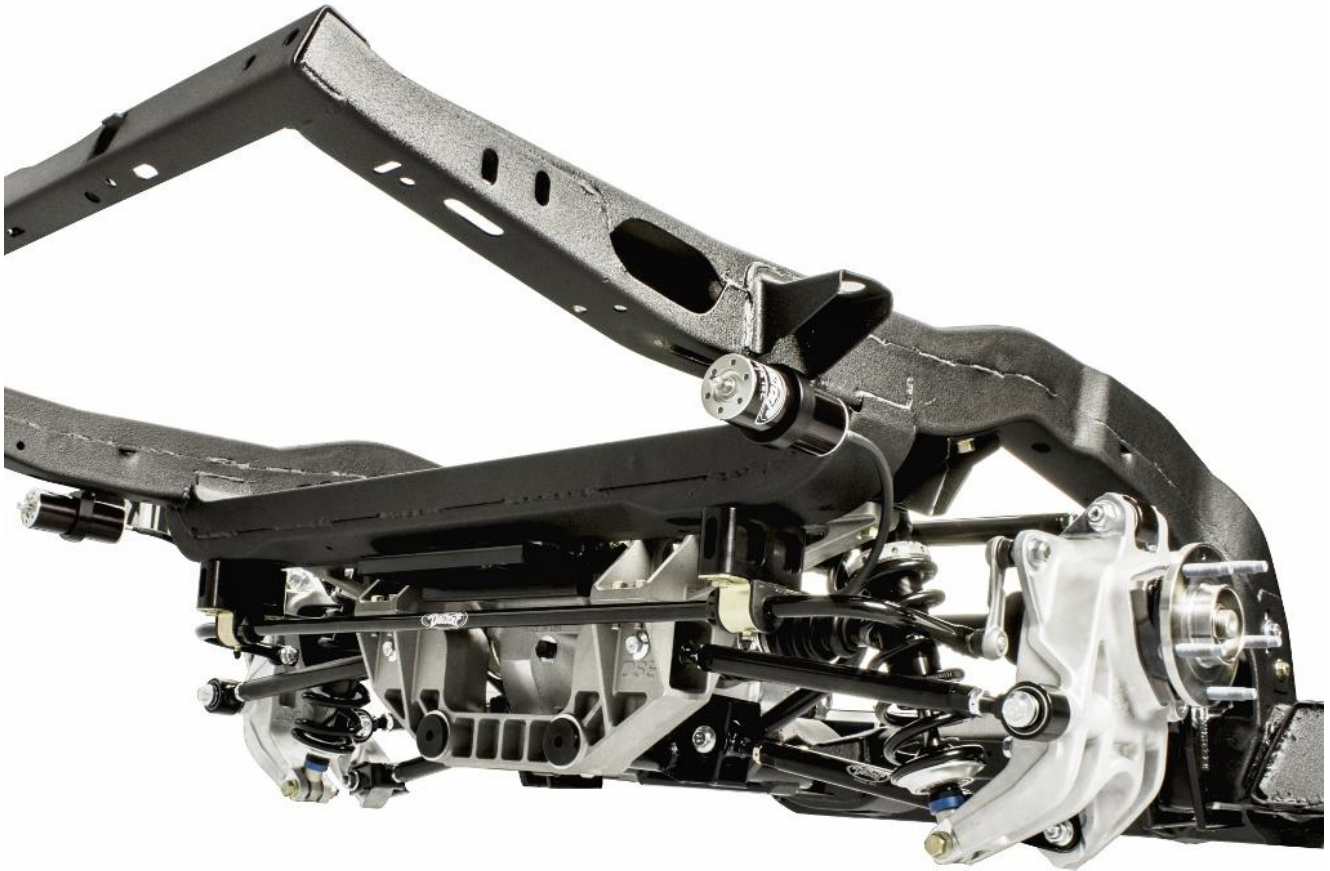

IMPORTANT

All work should be performed by a qualified welder and technician. Please read the entire set of instructions and fully understand all of the steps involved before beginning the project. Always make sure to wear the appropriate safety equipment for the job and properly support the vehicle. If you have any questions before, during, or after the installation, feel free to contact Detroit Speed by phone at (704) 662-3272 or by email at tech@detroitsspeed.com.

Item #	Description	Quantity
1	IRS Upper Cradle Assembly	1
2	IRS Lower Cradle Assembly	1
3	IRS Trailing Arm Bracket Assembly, LH and RH	2
4	IRS Cradle Tie Brace, LH and RH	2
5	IRS Trailing Link Assembly	4
6	IRS Lateral Link Assembly, Upper and Lower	4
7	IRS Toe Link Assembly	2
8	Differential Bracket Assembly, Upper and Lower	2
9	Forged Aluminum Upright Assembly, LH and RH	2
10	IRS Tubular 3/4" Sway Bar	1
11	Coilover Shock	2
12	Coilover Spring	2
13	Rear Half-shafts	2
14	Differential Stub Axle (P/N: 041740DS - 041742DS Only)	2
15	Hardware Kit	1
16	Instructions	1

NOTE: There is an installation video available through the DSE website under install video shown here: detroitsspeed.com/1963-82-corvette-installation-videos.

NOTES:

1. For 1963-67 vehicles, the area of the fiberglass body above the storage/battery compartments will need to be modified to clear the IRS DECALink. You will need to cut two holes to allow clearance for the top of the IRS cradle tie braces. You may also want to clearance the body right above the hole cutouts. One some applications, the DECALink crossmember could interfere with the body (Figure 1).



Figure 1 - C2 Body Modifications

2. For 1980-82 vehicles, the stock differential cannot be used with the IRS DECALink. You can use a stock differential from a 1968-79 vehicle or purchase a Hammerhead rear differential from Detroit Speed. You will also need to weld or bolt in the rear crossmember from a 1968-79 vehicle into your 1980-82 frame. Call Detroit Speed (704-662-3272) for further details.
3. Detroit Speed recommends installing the IRS DECALink with the body off the chassis however you can install this system with the body on the chassis. It is more difficult and will take more time to

install. Make sure you have the correct tools for this installation with the body on the chassis before you begin.

4. In order to install the Detroit Speed IRS DECALink, you will need the following additional tools:
 - Air Chisel
 - 90° Drill
 - Dyna-file
 - 29/64" Transfer Punch
 - 15/32" Transfer Punch
 - 18mm Socket/Wrench
 - 21mm Socket/Wrench
 - 1-5/16" Socket

5. If you have purchased Detroit Speed P/N: 041741DS or 041742DS, you will need to contact GearFX Driveline (704-799-0955) in order to use the provided 30-spline stub axles.

Specifications - Detroit Speed C2/C3 IRS DECALink	
Total Suspension Travel	6"
Ride Height*	3.0" ±1.0"
Static Camber	-.3 ±.2°
Static Toe	0° ±.1°
Total Bump Steer [20" toe span]	.027"
*Measured from bottom edge of upper cradle outer frame mount bracket to center of hub.	

Wheel & Tire Fitment (C2/C3 Stock Body)					
Diameter (in.)	Width (in.)	Backspacing (in.)	Lug Nut Thread Pitch	Recommended Tire Size	Comments
17*	8.0	4.00	5 X 4.75" M12x1.5	245/45R17	
	9.0	4.50		255/40R17	Max Width Recommended
18	8.0	4.00		245/40R18	
	9.0	4.50		255/35R18	
	10.0	5.50		275/35R18	Max Width Recommended
Wheel & Tire Fitment (C2/C3 w/Fender Flares)					
18	11.5	5.50	5 X 4.75" M12x1.5	315/30R18	
	12.5	5.50		335/30R18	Max Width Recommended
Wheel & Tire Fitment (Detroit Speed Fender Flares P/N: 010113)					
18	12.5	5.50	5 X 4.75" M12x1.5	335/30R18	Max Width Recommended
19	13	5.50		355/30R19**	

* 17" wheels require a minimum inside wheel diameter of 16.250"

Caution: Some brake applications will not work with 17" wheels. Flush mount valve stems may also be required on wheels with a behind center valve stem location.

**Due to the overall tire diameter, minor modification to the frame rail is required.

Optional Wheel Stud Kit - ARP 100-7708 - M12-1.5 x 2.5" L GM Wheel Stud Kit

Hardware Checklist – Detroit Speed C2/C3 IRS DECAlink			
Part Number	Description	Quantity	Check
9304336	Sway Bar Hardware Bag	1	
99040196	Sway Bar Frame Mount Bushing Bracket	2	
99040342	3/4" ID Polyurethane Sway Bar Bushing, Black	2	
99040009	Super Grease	1	
99040574	Sway Bar Bracket Spacer	2	
9303220	Sway Bar End Link Assembly	2	
9304193	3/4" Double Split Lock Collar Assembly	2	
9304335	ARB Bracket Mount Nut Plate Assembly	2	
950027FS	3/8"-16 x 3/4" L Hex Head Cap Screw, Yellow Zinc	4	
950108FS	3/8"-16 x 2-3/4" L Socket Head Cap Screw	4	
960081FS	M12-1.75 Flange Lock Nut, Clear Zinc	4	
970034FS	3/8" SAE Washer, Yellow Zinc	4	
970045FS	1/4" USS Washer, Clear Zinc	2	
980094FS	1/4"-28 x 1/2" L Hex Head Bolt, Clear Zinc	2	
9304337	Cradle Hardware Bag	1	
9304332	Lower Cradle Frameraill Mount Nut Plate Assembly	2	
9304333	Inboard Cradle Frameraill Mount Nut Plate Assembly	2	
9304334	Cradle Crossmember Mount Nut Plate Assembly	1	
920009FS	1/8" Thick, 1/2" Slot, 11/8" x 11/8" Shim	6	
920035FS	1/16" Thick, 1/2" Slot, 11/8" x 11/8" Shim	6	
920051FS	1-1/4" Recessed Head Button Plug	2*	
950109FS	8-32 x 1/2" L Flat Head Cap Screw	6	
960064FS	7/16"-14 Flange Lock Nut, Yellow Zinc	10**	
980097FS	7/16"-14 x 1-1/2" L Flange Head Hex Bolt, Yellow Zinc	8	
980073FS	7/16"-14 x 1" L Hex Head Bolt, Yellow Zinc	2	
980121FS	7/16"-14 x 3/4" L Hex Head Bolt, Yellow Zinc	2***	
970042FS	7/16" SAE Washer, Yellow Zinc	2	
980099FS	1/2"-13 x 1-1/4" L Flange Head Hex Bolt, Yellow Zinc	4	
980120FS	1/2"-13 x 1-3/4" L Flange Head Hex Bolt, Yellow Zinc	2	
9304338	Shock Hardware Bag	1	
9303244	Steel Bushing, 3/4" OD x 1/2" ID x 7/8" L, Yellow Zinc	2	
99030339	Tapered Spacer, Upper Shock Mount	4	
960063FS	1/2"-13 Flange Lock Nut, Yellow Zinc	2	
980058FS	1/2"-20 x 3" L Hex Head Bolt, Yellow Zinc	2	
980065FS	1/2"-13 x 3" L Flange Head Hex Bolt, Yellow Zinc	2	
031060	Detroit Speed/JRi Spanner Tool	1	
031062	Torrington Bearing Set	1	
9304339	Upper Differential Mount Hardware Bag	1	
960004FS	1/2"-20 Nylock Nut, Yellow Zinc	2	
970037FS	1/2" SAE Washer, Yellow Zinc	4	

970042FS	7/16" SAE Washer, Yellow Zinc	4	
980058FS	1/2"-20 x 3" L Hex Head Bolt, Yellow Zinc	2	
980073FS	7/16"-14 x 1" L Hex Head Bolt	4	
980095FS	M10-1.5 x 60mm, 12-point Bolt, Clear Zinc	12	
Hardware Checklist - Detroit Speed C2/C3 IRS DECAlink			
Part Number	Description	Quantity	Check
9304340	Lower Differential Mount Hardware Bag	1	
99040572	Frame Side Spherical Washer	2	
920037FS	3/4" ID x 1-1/2" OD x 0.048" Thick Shim	2	
920038FS	3/4" ID x 1-1/2" OD x 0.075" Thick Shim	1	
960004FS	1/2"-20 Nylock Nut, Yellow Zinc	2	
960017FS	7/16"-14 Nylock Nut, Yellow Zinc	2	
960097FS	5/8"-18 Flange Lock Nut, Yellow Zinc	1	
970037FS	1/2" SAE Washer, Yellow Zinc	4	
970042FS	7/16" SAE Washer, Yellow Zinc	4	
980058FS	1/2"-20 x 3" L Hex Head Bolt, Yellow Zinc	2	
980089FS	7/16"-14 x 4-1/4" L Hex Head Bolt, Yellow Zinc	2	
980100FS	5/8"-18 x 1-3/4" L Flange Head Hex Bolt, Yellow Zinc	1	
9304341	Trailing Arm Link Bracket Hardware Bag	1	
9304331	Trailing Link Bracket Frame Mount Nut Plate Assembly	2	
99020115	1/8" x 6" L Extension Drill Bit	1	
99020117	19/32" Reduced Shank Drill Bit	1	
99040566	Trailing Arm Bracket Frame Doubler	4	
99040583	Trailing Arm Bracket Drill Guide	1	
99040567	1/8" Trailing Arm Bracket Shim	4	
99040568	1/16" Trailing Arm Bracket Shim	2	
99040569	1/32" Trailing Arm Bracket Shim	2	
99040570	Trailing Link Bracket Collapsible Crush Sleeve, Female Side	2	
99040571	Trailing Link Bracket Collapsible Crush Sleeve, Male Side	2	
950109FS	8-32 x 1/2" L Flat Head Cap Screw	2	
960017FS	7/16"-14 Nylock Nut, Yellow Zinc	2	
960037FS	7/16"-14 Hex Nut, Yellow Zinc	2	
970042FS	7/16" SAE Washer, Yellow Zinc	4	
980097FS	7/16"-14 x 1-1/2" L Flange Head Hex Bolt, Yellow Zinc	4	
980101FS	7/16"-14 x 4-1/2" L Hex Head Bolt, Yellow Zinc	2	
9304342	Link Hardware Bag	1	
960098FS	M14-2.0 Flange Lock Nut, Clear Zinc	12	
980102FS	M14-2.0 x 70mm Flange Head Hex Bolt, Clear Zinc	6	
980103FS	M14-2.0 x 80mm Flange Head Hex Bolt, Clear Zinc	8	
980104FS	M14-2.0 x 90mm Flange Head Hex Bolt, Clear Zinc	2	
980105FS	M14-2.0 x 100mm Flange Head Hex Bolt, Clear Zinc	2	
980106FS	M14-2.0 x 120mm Flange Head Hex Bolt, Clear Zinc	2	

* If you are installing with the body off the chassis, you will not use the button plugs.

** If you are installing with the body off the chassis, you will only need 8 lock nuts.

*** If you are installing with the body off the chassis, you will not use the 3/4" long bolts.

Fastener Torque Specifications - Detroit Speed C2/C3 IRS DECALink		
Application	Torque (ft-lb)	Threads
Weld Nut Plate Retaining Screws	2	Blue Loctite 242
Upper Cradle to Frame (1/2" Bolts)	70	Blue Loctite 242
Upper Cradle to Frame (7/16" Bolts)	50	Blue Loctite 242
Differential Housing/Cover to Mounting Bracket Bolts	50	Blue Loctite 242 (Cover Bolts)
Differential Bracket Bushing Bolts	70	Anti-Seize
Differential Cover to Housing	20	Black Silicone
Front Lower Cradle to Frame Bracket Bolt	150	Anti-Seize
Upper to Lower Cradle Mounting Bolts	50	Anti-Seize
Trailing Arm Bracket (7/16" Bolts)	40	Anti-Seize
Suspension Link M14 Attachment Bolts	120	Blue Loctite 242 (blind holes only)
Inner CV Joint to Stub Axle Flange Bolts	57	Blue Loctite 242
Outer CV Joint to Hub Nut	140	Red Loctite 262
Coilover Shock Mounting Bolts	60	Blue Loctite 242 (Upper Bolt), Anti-Seize (Lower Bolt)
Sway Bar Bracket Spacer Bolts	40	Blue Loctite 242
Sway Bar Bushing Bracket Mounting Bolts	35	Blue Loctite 242
Sway Bar Shaft Clamp Screw	12	Blue Loctite 242
Sway Bar Link Nuts	45	
Suspension Link Adjuster Jam Nuts	55	
Wheel/Hub Bearing Mounting Bolts	95	Red Loctite 272
Rear Brake Caliper Mounting Bracket Bolts	125	Red Loctite 272
Wheel Stud Nuts	100	
Upper Cradle Casting 5/16" Bolts	24	Blue Loctite 242
Upper Cradle Casting 7/16" Bolts	50	Blue Loctite 242

CAUTION:

The Detroit Speed serial number tag is the best identification record of your subframe when contacting DSE to determine when your IRS system was assembled for any warranty issues should you need them (Figure 2). Detroit Speed does not recommend powder coating the rear cradle crossmember as that will cause permanent damage to your serial tag number. If it is damaged it would be much more difficult to properly ID, your Detroit Speed IRS DECALink.



Figure 2 – Serial Tag

Installation:

1. Remove all the factory rear suspension from the frame including the rear differential. Remove the frame crossmember and cut off the mounting brackets off both sides of the frame (Figure 3). Grind the remaining weld left on the frame for a smooth, clean finish.

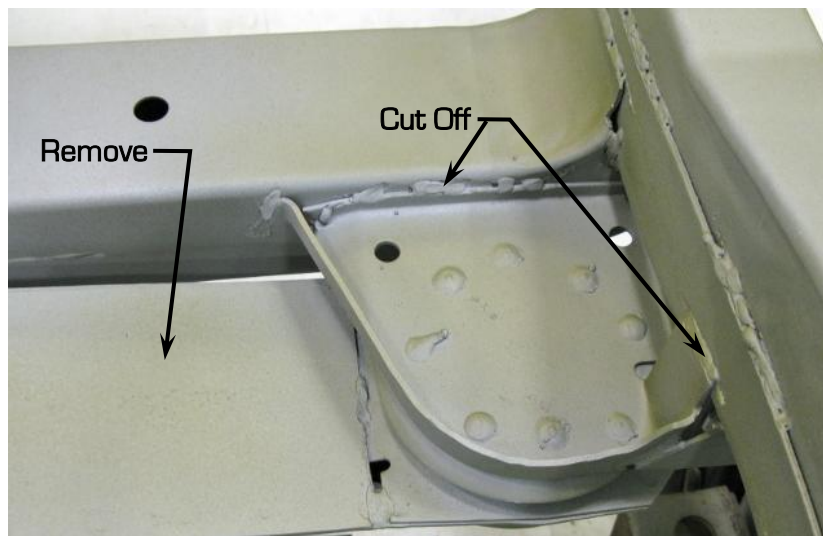

Figure 3 – Remove Frame Crossmember Brackets

2. Cut off the frame bumper brackets on both sides of the frame along with the upper shock mount brackets (Figure 4). Grind the bottom of the framerail smooth for a clean finish.

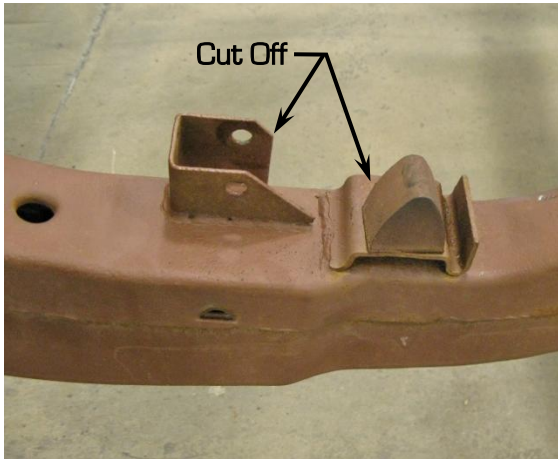

Figure 4 – Remove Frame Bumper and Upper Shock Mount Brackets

3. Cut off the brake line brackets from the frame. Also remove the trailing arm bolt doubler from the inside and outside of each framerail (Figure 5). Grind any excess weld smooth for a clean finish.

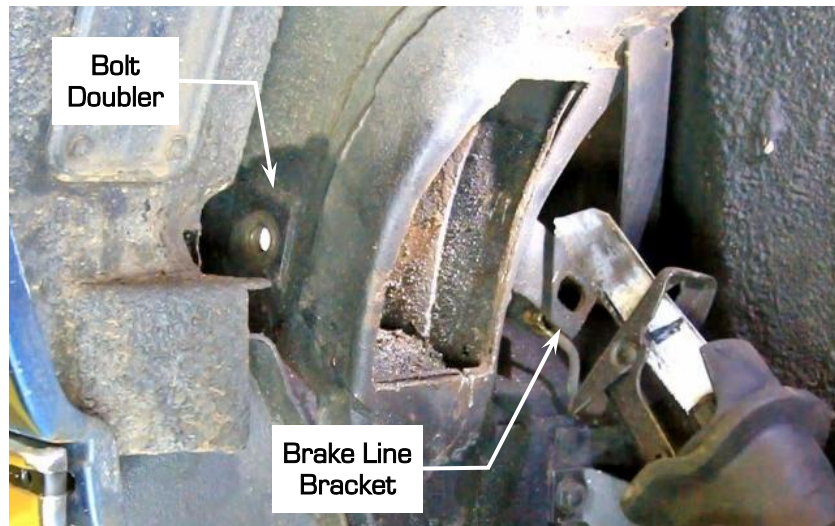

Figure 5 – Remove Park Brake Cable Bracket and Trailing Arm Bolt Doubler

4. For the later year applications, the trailing arm pocket doubler plate located inside the trailing arm pocket will need to be removed from the frame (Figure 6). Grind any excess weld smooth for a clean finish.

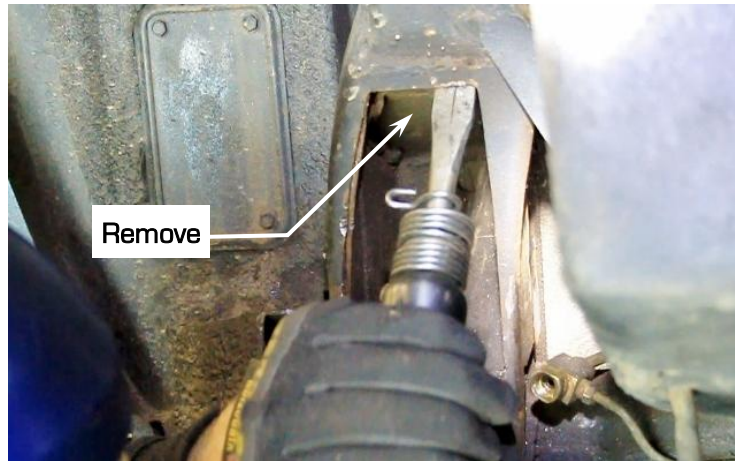

Figure 6 - Remove Doubler Plate

5. With the frame on jack stands or on a lift, record the angle of the frame along the bottom side of the frame rail, underneath the trailing link pocket. (Figure 7).



Figure 7 - Level Frame

6. Place the provided trailing arm bracket frame drill guides on the outside and the inside of each framerail. Install the provided $7/16$ "-14 x $4-1/2$ "L hex head bolt and washer through the inside drill guide, through the trailing arm bolt hole and through the outside drill guide. Using the angle of the frame recorded in step 5, level and match the bottom edge of the drill guides with the angle of the frame. Hold in place by tightening the provided $7/16$ "-14 hex nut (Figure 8).



Figure 8 - Level Frame Doubler Plates

7. Trace the bottom and back edge of the inner and outer frame drill guides with a marker (Figure 9). Remove the frame drill guides from the frame.

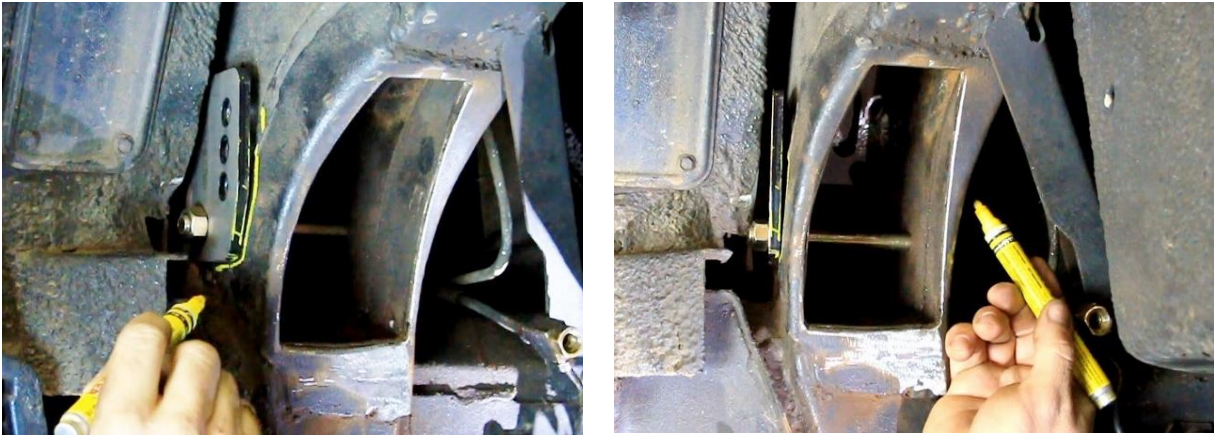

Figure 9 – Trace Outer and Inner Frame Doubler Plates

8. You will need to cut and grind away some of the factory frame rail layers/weld to allow the frame doubler plates to sit flat on both sides of the frame rail (Figure 10). **CAUTION:** Be careful not to cut too much away or you will need to fill in any gaps left over between the doubler plate and the frame.

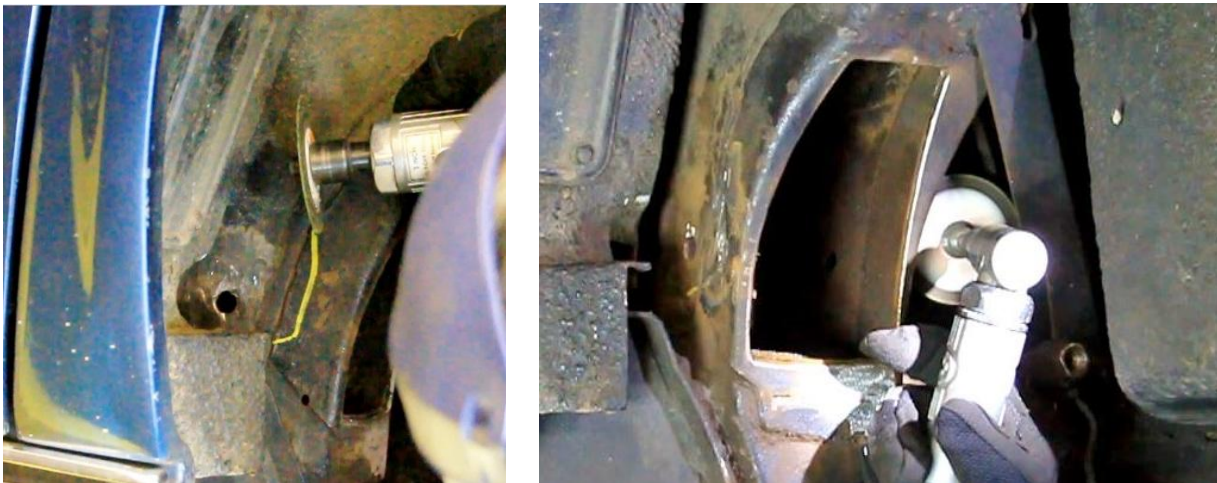

Figure 10 – Trim Frame for Doubler Plates

9. Remove and grind any excess weld smooth for a clean finish on both sides of the frame rail. Install the 7/16"-14 hardware from step 6 and place the outer and inner frame drill guides against the frame rail. Verify that both drill guides will sit flat and level to the frame rail (Figure 11).



Figure 11 – Verify Frame Rail Modification

NOTE: If you are installing this kit with the body off the frame, you can now transfer punch the 3 upper link holes to the frame rail using the outer drill guide.

10. Remove the drill guides from the frame rail. Using the 7/16"-14 hardware and one of the provided doubler plates, level the outer frame doubler plate to the frame rail and tack weld in place in a few spots (Figure 12).



Figure 12 - Tack Weld Doubler Plate

11. Remove the rear body mount cover to gain additional room to drill the trailing link holes. Mark the center of the 3 doubler plate holes and snap punch all 3 locations (Figure 13).



Figure 13 - Center Punch Trailing Link Holes

12. Starting with a 1/8" drill bit, drill all 3 trailing link holes. Gradually step up in drill size and use the provided 19/32" drill bit for the final hole size to match the hole size in the outer frame doubler plate (Figure 14).



Figure 14 – Drill Trailing Link Holes

13. Remove any burrs left from drilling by grinding the outer doubler plate smooth for a clean finish (Figure 15).



Figure 15 – De-burr Doubler Plate

14. Use the provided 7/16"-14 x 1-1/2"L flange head bolt and nut, install the frame rail drill guide on the inside of the inner frame rail. Level the drill guide in the frame rail to match the frame and tighten the 7/16"-14 hardware. Mark the bottom edge of the drill guide for a reference line (Figure 16).



Figure 16 – Level Drill Guide

NOTE: If you are installing this kit with the body removed from the frame, you can now transfer punch the 3 upper link holes to the frame rail using the outer drill guide.

15. Using the provided 19/32" drill bit, locate all 3 holes on the inner frame rail passing the drill bit through the outer frame doubler plate to the inner drill guide. Remove the drill guide from inside the frame rail and snap punch the 3 hole locations on the inside frame rail (Figure 17)

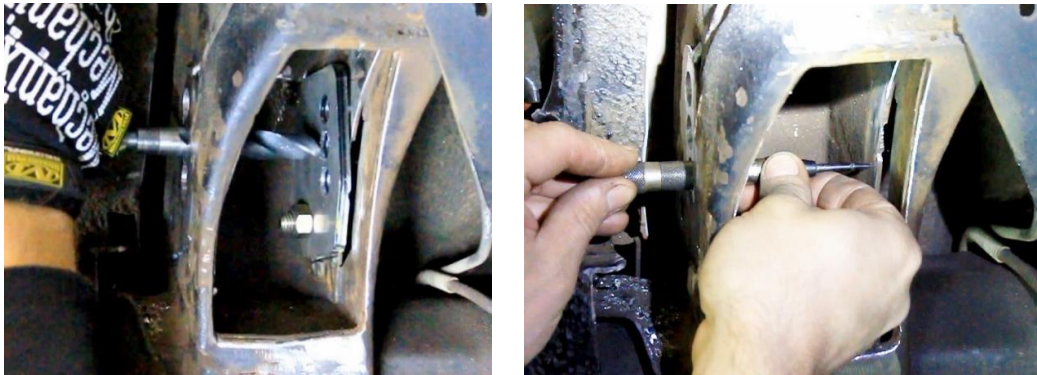

Figure 17 - Center Drill Inner Frame Rail

16. Place the provided extended length 1/8" drill bit through the middle link hole in the outer doubler plate. Locate the drill bit to the center mark made in the previous step. Drill a pilot hole through the inside frame rail. Gradually step up in drill size and use the provided 19/32" drill bit for the final hole size to match the hole size in the outer frame doubler plate (Figure 18). Grind any burrs on the inner frame rail smooth for a clean finish.

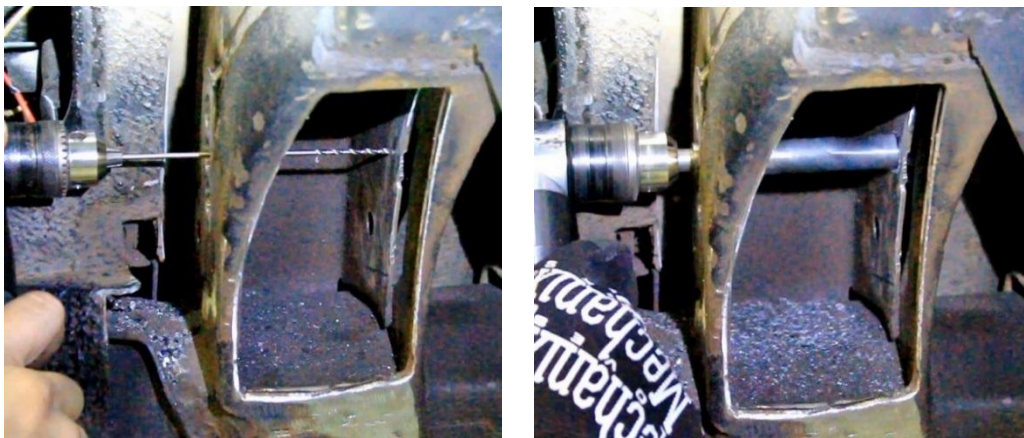

Figure 18 - Drill Inner Frame Rail

17. Install the inner frame rail doubler plate using the provided 7/16"-14 hex head bolt and nut through the inboard side of the frame rail. Place one of the M14-2.0 bolts from the link hardware kit through the middle link hole in the inner doubler plate to verify that the doubler plates are lined up (Figure 19).

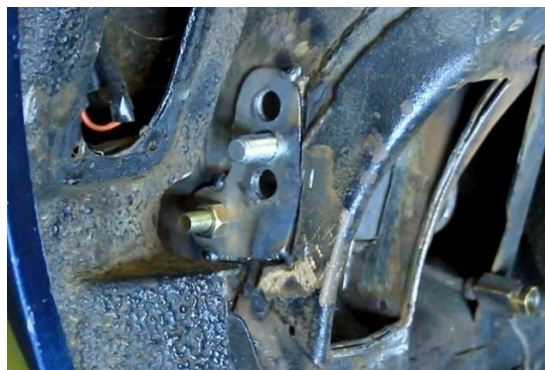

Figure 19 - Locate Inner Doubler Plate

18. Weld the inner doubler plate to the inner frame rail inside the trailing link pocket where the frame rail was cut for the doubler plate. Grind smooth for a clean finish (Figure 20)



Figure 20 – Weld Inner Frame Rail

19. Place the extended length 1/8" drill bit through the upper and lower link hole in the outer doubler plate. Locate the drill bit to the center mark made in Step 15. Drill a pilot hole through the inside frame rail. Gradually step up in drill size and use the provided 19/32" drill bit for the final hole size to match the hole size in the outer frame doubler plate. Grind any burrs on the inner frame rail smooth for a clean finish (Figure 21).

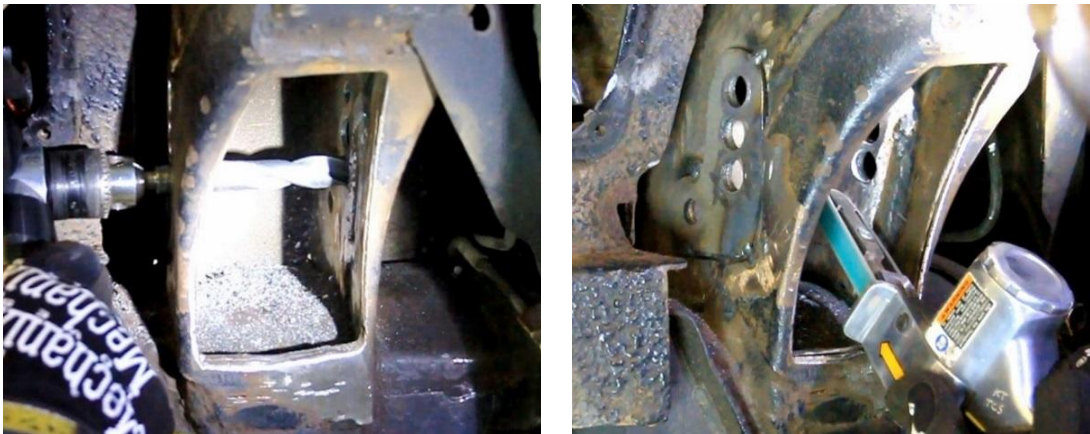

Figure 21 – Drill Upper & Lower Link Holes

20. Finish weld around the perimeter of the inner and outer frame doubler plates to the frame rail. Grind smooth for a clean finish (Figure 22). Repeats **steps 6-20** for the opposite side of the vehicle.



Figure 22 - Finish Weld Doubler Plates

21. Install the IRS trailing link bracket assembly into the framerrail using the provided 7/16"-14 x 4-1/2"L hex head bolt, washers and hex nut that have been used in the previous steps. Make sure you have the correct side trailing link bracket as the lower link attachment will be offset towards the center of the vehicle. Place the collapsible crush sleeve inside the trailing arm frame pocket on the 7/16"-14 hex head bolt (Figure 23). **NOTE:** Detroit Speed recommends greasing the collapsible crush sleeve before it is installed.

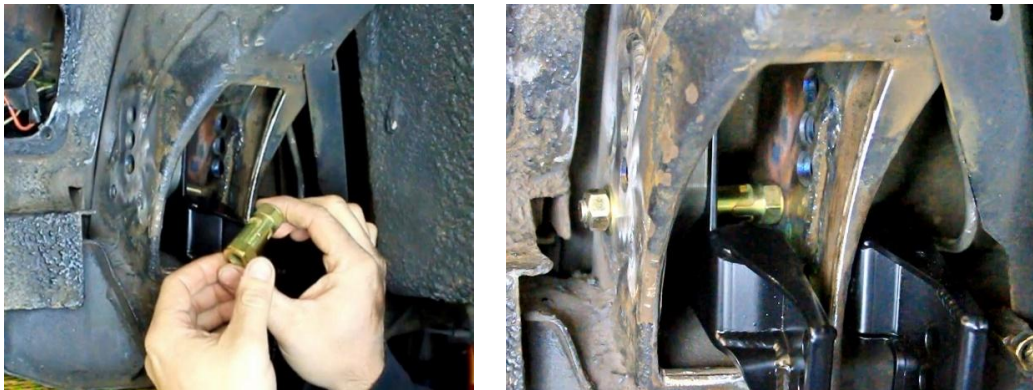

Figure 23 - Trailing Link Bracket

22. Install the M14-2.0 x 120mm flange head bolt, through the top link hole to keep the trailing link bracket assembly from moving. Then, expand the crush sleeve on the 7/16"-14 hex head bolt with two 3/4" wrenches (Figure 24).



Figure 24 - Expand Crush Sleeve

23. Transfer punch the 2 bottom frame mounting holes with a 29/64" transfer punch, using the trailing arm bracket assembly as a template (Figure 25). Remove the trailing link bracket assembly.



Figure 25 - Transfer Punch & Drill the Frame

24. Take one of the trailing link bracket shims from the hardware kit and place it over the holes that were just punched. Some frames may need the gusset trimmed back so the shim can lay flat against the frame (Figure 26).

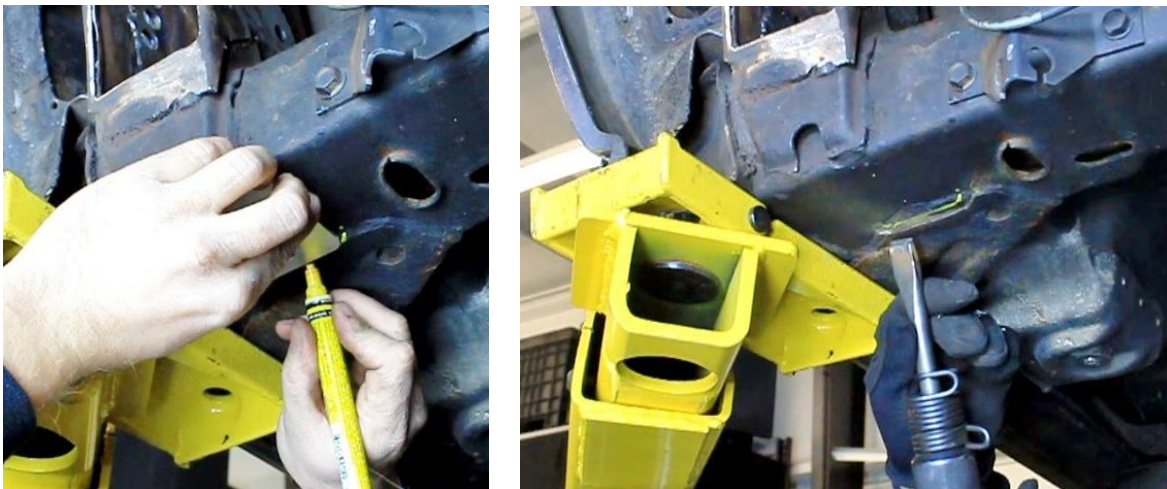

Figure 26 - Trim Frame Gusset

25. Once the gusset has been trimmed, Detroit Speed recommends welding the gusset where it was trimmed to the framerail. Grind smooth for a clean finish (Figure 27).



Figure 27 – Weld & Grind Gusset

26. Snap punch 2 marked drill locations from Step 23. Start with a 1/8" pilot drill and drill into the frame (Figure 28). Gradually step up your drill size until you have a 15/32" final drill size. Chamfer the holes as needed.



Figure 28 – Drill Trailing Arm Bracket Mounting Locations

27. Install the provided 7/16"-14 x 1-1/2"L flange head bolts into the trailing link bracket nut plate. **NOTE:** You may want to run a 7/16"-14 and 8-32 tap through the nut plate to make sure the threads are clean for the fasteners. Wrap the threads of the bolts in masking tape and place the nut plate with the bolts installed into the holes that were drilled in step 23. Holding the nut plate in place, transfer punch the small hole in between the 2 bolts to the frame. Remove the nut plate and snap punch the marked location. Drill a hole using an 11/64" final drill bit size for the 8-32 fastener. Chamfer the hole using a large drill bit or chamfer tool until the 8-32 x 1/2"L flat head cap screw sits flush with the bottom of the frame (Figure 29).



Figure 29 – Trailing Link Bracket Nut Plate

28. Fabrication is now complete on the frame to the point where you can powdercoat your frame. If you are doing a body on install, you can paint the areas that have been modified to prevent the bare metal from rusting (Figure 30).



Figure 30 – Paint Modified Frame Rails

29. Place the trailing link bracket nut plate inside the frame through the slot in the frame (Figure 31 on the next page) using a wire and/or magnet to locate it in place. **NOTE:** Once you get the nut plate close to the holes it may be easier to thread in one of the 7/16"-14 flange head bolts into the nut plate to hold it while you install the 8-32 flat head cap screw. Use medium strength blue Loctite 242 on the threads of the screw and tighten. Remove the 7/16"-14 flange head bolts from the nut plate. Repeat **steps 21-29** for the opposite side of the vehicle.

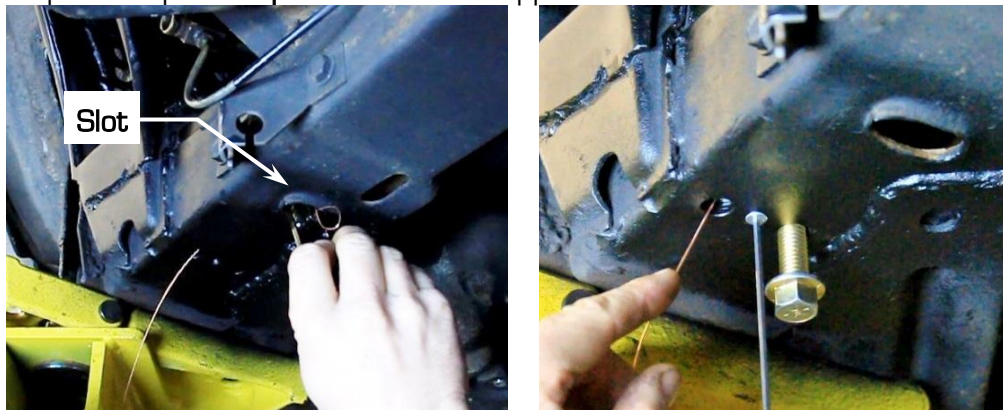

Figure 31 – Install Trailing Link Bracket Nut Plate

30. Install the 7/16"-14 x 4-1/2"L hex head bolt and washer from the inside of the framerail through the factory trailing link hole in the frame and through the trailing link bracket. Slide the collapsible crush sleeve onto the 7/16"-14 bolt and pass it through the outside of the framerail. Install the provided 7/16"-14 Nylock nut and washer on the 7/16"-14 hex head bolt by hand.

31. Install the M14-2.0 trailing link bolts through the center hole in the trailing link brackets. Expand the crush sleeves with two 3/4" wrenches (Figure 32). Leave the hardware loose until after the links are installed.



Figure 32 - Install Trailing Link Bracket

32. Measure the gap between the trailing arm bracket and the bottom of the frame crossmember. Use the provided shims and install them between the trailing link bracket and the bottom of the crossmember. Install and tighten the 7/16"-14 x 1-1/2"L flange head bolts through the trailing link bracket and into the nut plate. (Figure 33). Repeat this steps 30-32 for the opposite side of the vehicle. **NOTE:** Do not torque the hardware at this time.

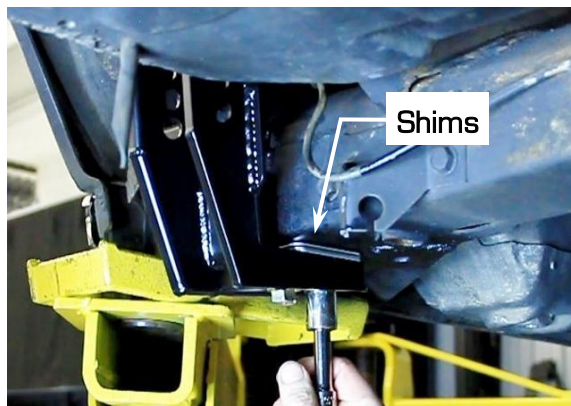

Figure 33 - Install Trailing Arm Bracket Assembly

33. Next, install the cradle crossmember mount nut plate assembly to the frame crossmember. Install the 1/2"-13 x 1-3/4"L flange head hex bolts into the nut plate assembly. **NOTE:** You may want to run a 1/2"-13 tap through the nut plate to make sure the threads are clean for the fasteners. Wrap the threads of the bolts in masking tape and place the nut plate with the bolts installed, into the existing holes in the frame crossmember. Holding the nut plate in place, mark the 2 small holes in the nut plate to the frame crossmember. Remove the nut plate (Figure 34).



Figure 34 - Cradle Crossmember Nut Plate Location

34. Snap punch and drill out these 2 holes using an 11/64" final drill bit size for the 8-32 fastener. Chamfer the holes using a large drill bit or chamfer tool until the 8-32 x 1/2"L flat head cap screws sit flush with the bottom of the frame (Figure 35).



Figure 35 - Drill & Chamfer Holes

35. Bend the crossmember nut plate slightly at the v-notch in the middle just enough to fit inside the frame crossmember at the large hole at either end. Use a wire and/or magnet to position the nut plate in the crossmember (Figure 36).



Figure 36 - Bend Crossmember Nut Plate

36. Position the nut plate in the crossmember so you can thread one of the 1/2"-13 x 1-3/4"L flange head hex bolts into the nut plate. Use a drift or a punch in the open hole of the nut plate to get the other fastener installed. Tighten both 1/2"-13 bolts so that the nut plate straightens out inside the crossmember. **NOTE:** You may want to back off the 1/2"-13 fasteners and run an 8-32 tap through the nut plate to make sure the threads are clean for the fasteners (Figure 37).



Figure 37 – Straighten Nut Plate & Clean Threads

37. Install the 8-32 x 1/2"L fasteners using medium strength blue Loctite 242 on the threads of the screws and tighten (Figure 38). Remove the 1/2"-13 fasteners.



Figure 38 – Install Crossmember Nut Plate

38. Next, in order to install the cradle mount assembly nut plates, you will need to assemble the IRS upper cradle assembly to the IRS lower cradle assembly and position it to the frame. Use the 8 provided 7/16"-14 x 1-1/2"L flange head hex bolts and flange lock nuts to assemble the IRS cradle using anti-seize on the threads (Figure 39). **NOTE:** The bolts should be pointing down (head of the bolts pointing up). Do not torque the bolts at this time.

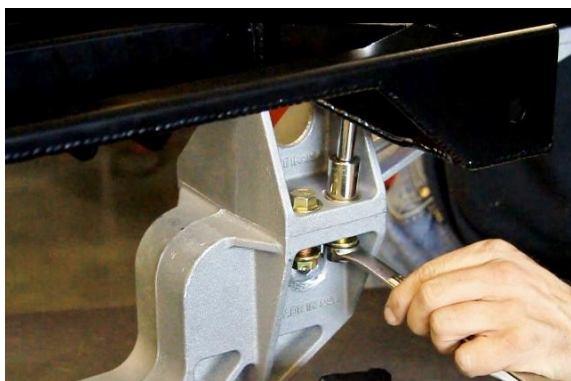

Figure 39 – Assemble the IRS Cradle

39. Before the IRS cradle is installed, make sure the upper shock mounting holes on both sides of the cradle are clean and free of any powdercoat so the coilover shock bolts and spacers slide into the mounts (Figure 40).

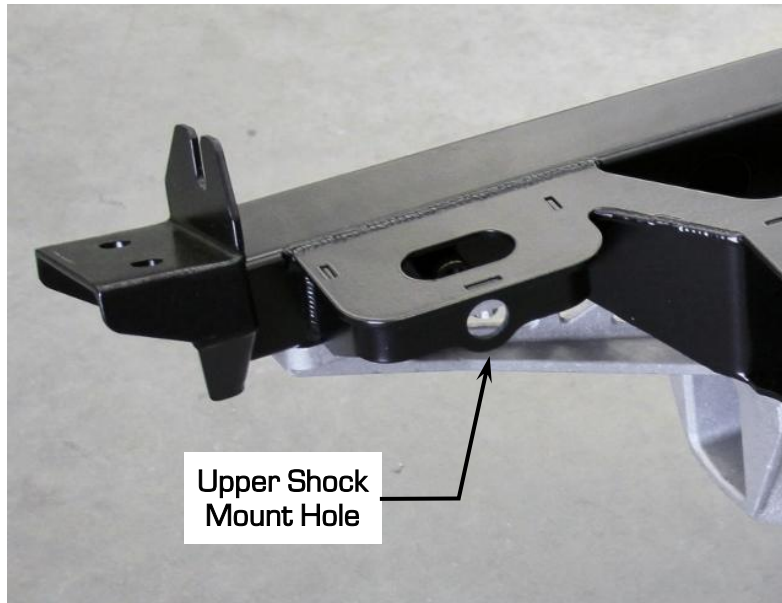

Figure 40 – Upper Shock Mount

40. Position it under the frame so that the lower cradle differential mount lines up with the differential mount on the frame. Use the provided 5/8"-18 x 1-3/4"L flange head hex bolt and flange lock nut to bolt the lower cradle differential mount to the mount on the frame. **NOTE:** One set of the frame side and misalignment side spherical washers will be used under the bolt head and between the differential mount on the frame. The other set will be used between the differential mount on the frame and the lower cradle differential mount (Figure 41). Install the 5/8"-18 flange lock nut loosely onto the bolt.

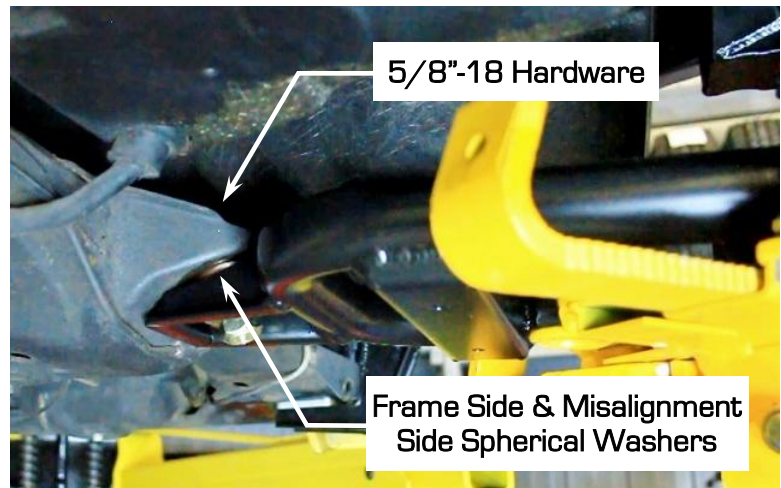
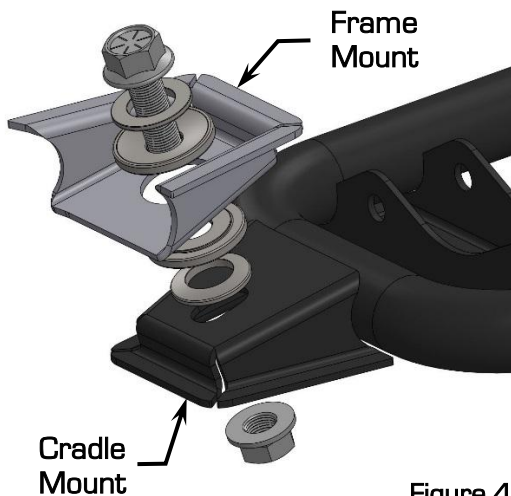

Figure 41 – Bolt Lower Cradle to Frame

41. Install the 2 provided 1/2"-13 x 1-3/4"L flange head bolts through the back of the IRS cradle assembly and into the crossmember nut plate. Use the slotted shims to level the IRS cradle to the crossmember. Center and level the IRS cradle assembly to the frame. The lower cradle differential mount has a slotted hole for adjustment as well as the provided shims. **NOTE:** The distance from the back edge of the IRS cradle crossmember to the front edge of the frame crossmember should be 2-3/8" ± 1/16" (Figure 42 on the next page).



Figure 42 - Level IRS Cradle to the Frame

42. Once the IRS cradle is centered and leveled, tighten the 5/8"-18 x 1-3/4"L flange bolt along with the 1/2"-13 flange head bolts in the crossmember. Verify the IRS cradle is centered.
43. Transfer punch both holes on both sides of the frame in the IRS cradle crossmember onto the bottom side of the frame using a 1/2" transfer punch (Figure 43). The holes in the crossmember are slightly over 1/2" so you may need to wrap some tape around the 1/2" transfer punch.



Figure 43 - Transfer Punch Frame for IRS Cradle

NOTE: If you are installing the DECALink with the body off the chassis, continue onto the next step. If you are installing this kit with the body on the chassis, skip to Step 50.

44. Transfer punch the inside hole onto the inside of the frame using a 15/32" transfer punch (Figure 44). For both sides of the frame, you should transfer punch a total of 6 hole locations.



Figure 44 – Transfer Punch Frame for IRS Cradle

45. Center punch all locations and drill the 4 holes on the bottom side of the frame rail. Start with a 1/8" pilot drill and gradually step up to a final drill size of 1/2" (Figure 45). Center punch and drill the 2 holes on the inside surface of the frame rail. Start with a 1/8" pilot drill and gradually step up to a final drill size of 15/32". **CAUTION:** Make sure the drill does not walk as these holes are critical for the upper IRS cradle crossmember to be bolted to the frame. If the frame holes do not line up with the IRS crossmember, it will not bolt into the frame during final installation.



Figure 45 – Drill IRS Cradle Mount Locations

46. Once all 6 holes are drilled on both frame rails, remove the IRS cradle from the frame. Install the provided 1/2"-13 x 1-1/4"L flange head hex bolts into the lower cradle framerail mount nut plate assembly and install the provided 7/16"-14 x 1-1/2"L flange head hex bolts into the inboard cradle framerail mount nut plate assembly. **NOTE:** You may want to run a 1/2"-13 or 7/16"-14 and 8-32 tap through the nut plates to make sure the threads are clean for the fasteners. Wrap tape around the threads of the bolts if needed and place the nut plate assemblies on the frame with the bolts fitting into the holes that were drilled in the previous step. Mark the hole locations for the 8-32 fasteners (Figure 46).



Figure 46 – Framerail Nut Plate Location

47. Remove the nut plate assemblies and drill out these 4 holes using an 1 1/64" final drill bit size for the 8-32 fastener. Chamfer the holes using a large drill bit or chamfer tool until the 8-32 x 1/2"L flat head cap screws sit flush with the frame (Figure 47).

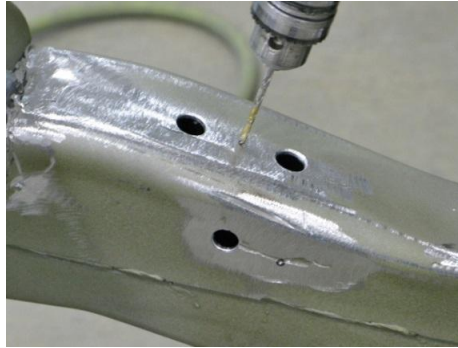

Figure 47 – Drill & Chamfer Nut Plate Locators

48. Once the 8-32 fasteners will sit flush with the frame, the nut plate assemblies will need to be mounted inside the framerail. They can be pulled through the frame by looping wire through the nut plates and pulling them up to the mounting location in the frame (Figure 48). **NOTE:** A magnet can also be helpful to line up the nut plate assemblies.



Figure 48 – Position Nut Plate Assemblies

49. You can also use the 7/16"-14 or 1/2"-13 hardware to help hold the nut plates in place while you install the 8-32 x 1/2"L flat head cap screws. Use medium strength blue Loctite 242 on the threads of the screws and tighten (Figure 49). Install all 4 nut plate assemblies into both framerails. **Continue on to Step 61.**



Figure 49 – Install Nut Plate Assemblies

50. Scribe the inside mounting hole location onto both sides of the inner frame using the IRS cradle crossmember as your template (Figure 50).



Figure 50 - Scribe Inside Mounting Hole Location

51. Snap punch and drill the four holes on the bottom side of both frame rails. Start with a 1/8" pilot drill and gradually step up to a final drill size of 1/2" (Figure 51). **CAUTION:** Make sure the drill does not walk as these holes are critical for the upper IRS cradle crossmember to be bolted to the frame. If the frame holes do not line up with the IRS crossmember, it will not bolt into the frame during final installation. Remove the IRS cradle assembly from the vehicle.



Figure 51 - Drill Bottom Side of Frame

52. Use a marker to locate the hole center from the scribed mark you made in **Step 50** on both frame rails. Snap punch both marked locations. Measure the distance from the bottom of the frame rail up to your center mark location. Then measure the distance from the front side of the frame crossmember to your center mark location (Figure 52).



Figure 52 - Locate Inside Mounting Holes

53. Locate the inside mounting hole locations to the outside frame rail to be used as an access hole using the measurements from the previous step (Figure 53).



Figure 53 – Locate Access Holes

54. Snap punch and drill a 1/8" pilot hole at your center mark on the outside of the framerail. Line up the drill through the outside frame rail to the inside frame rail so that when you drill through you will line up with the mark made on the inner frame rail from Step 52 (Figure 54).



Figure 54 – Drill through Frame Rail

55. Using a rotor broach or a hole saw, open up the outside frame rail access hole to a 1-1/4" diameter at your center mark location (Figure 55). Chamfer the hole as needed.



Figure 55 – Access Hole

56. Line up the drill bit to locate with your pilot hole on the inside frame rail. Gradually step in drill sizes up to a final drill size of 15/32" (Figure 56). **CAUTION:** Make sure the drill does not walk as these holes are critical for the upper IRS cradle crossmember to be bolted to the frame. If the frame holes do not line up with the IRS crossmember, it will not bolt into the frame during final installation. Chamfer the drilled hole as needed. Repeat **steps 54-56** for the opposite side of the vehicle.



Figure 56 – Drill Inner Mounting Hole

57. Once a total of 6 holes are drilled on both frame rails, install the provided 1/2"-13 x 1-1/4"L flange head hex bolts into the lower cradle framerail mount nut plate assembly. **NOTE:** You may want to run a 1/2"-13 and 8-32 tap through the nut plate to make sure the threads are clean for the fasteners. Wrap tape around the threads of the bolts if necessary and place the nut plate assembly on the frame with the bolts fitting into the holes. Mark the hole locations for the 8-32 fasteners on both framerails (Figure 57).



Figure 57 – Framerrail Nut Plate Location

58. Remove the nut plate assemblies. Snap punch and drill out these two holes using an 11/64" final drill bit size for the 8-32 fastener. Chamfer the holes using a large drill bit or chamfer tool until the 8-32 x 1/2"L flat head cap screws sit flush with the frame (Figure 58).

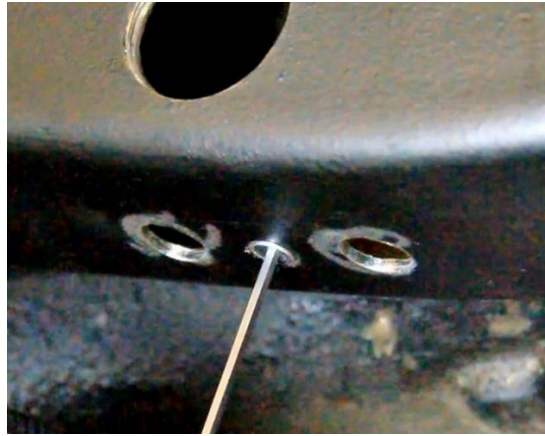

Figure 58 – Drill & Chamfer Nut Plate Locators

59. Install the lower cradle frame rail mount nut plate assemblies into both sides of the frame rail. They can be pulled through the frame by looping wire through the nut plates and pulling them up to the mounting location in the frame through the trailing link pocket (Figure 59). **NOTE:** A magnet can also be helpful to line up the nut plate assemblies.



Figure 59 – Locate Lower Cradle Nut Plate

60. Use the 1/2"-13 hardware to help hold the nut plates in place while you install the 8-32 x 1/2"L flat head cap screws. Use medium strength blue Loctite 242 on the threads of the screws and tighten (Figure 60). Repeat **steps 57-60** for the opposite side of the vehicle.



Figure 60 – Install Nut Plate Assemblies

61. The last nut plate assembly to be installed will be for the sway bar. Using the existing outer most hole in the rear frame crossmember, find the center of the hole and draw extension lines outward from the center using a straight edge. (Figure 61).



Figure 61 - Sway Bar Nut Plate Location

62. Place the sway bar bracket mount nut plate assembly on the rear crossmember with tape and center the 1/4"-28 tapped hole to the existing hole in the rear crossmember using the drawn extension lines. Transfer punch two hole locations using a 5/16" transfer punch (Figure 62). Remove the nut plate.

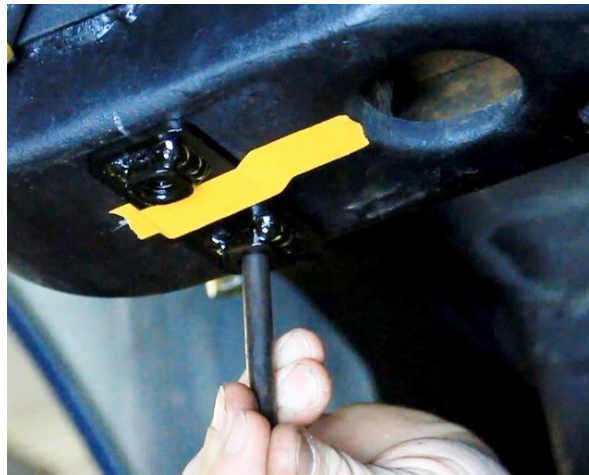

Figure 62 - Transfer Punch Nut Plate Location

63. Snap punch your 2 locations and start with a 1/8" pilot drill and gradually step up to a final drill size of 3/8" (Figure 63). Chamfer the drilled holes as needed. Spray paint this area if needed to keep any bare metal from rusting.



Figure 63 - Drill Sway Bar Nut Plate Location

64. Place the nut plate assembly through the large existing hole in the frame crossmember and locate the nut plate to the 3/8" holes that were drilled. **NOTE:** You may want to run a 3/8"-16 and 1/4"-28 tap through the nut plate to make sure the threads are clean for the fasteners. Use the provided 3/8"-16 x 2-3/4"L socket head cap screws to help locate the nut plate (Figure 64).



Figure 64 - Locate Sway Bar Nut Plate

65. Install the 1/4"-28 x 1/2"L long hex head bolt and washer into the nut plate assembly. Use medium strength blue Loctite 242 on the threads and tighten (Figure 65). Remove the 3/8"-16 hardware.



Figure 65 - Install Sway Bracket Nut Plate Assembly

66. Next install the sway bar aluminum bracket spacers to the rear crossmember using the provided 3/8"-16 x 2-3/4"L socket head cap screws using a 5/16" hex drive bit. Use medium strength blue Loctite 242 on the bolts and torque to 40 ft-lbs. (Figure 66). Repeat **steps 61-66** for the opposite side of the frame crossmember.



Figure 66 – Install Sway Bracket Spacer

67. If you are using the stock differential housing, install the provided stub axle shafts into the rear differential (Figure 67). If you have purchased a ZR12 rear differential (P/N: 070650), proceed to **Step 74**.

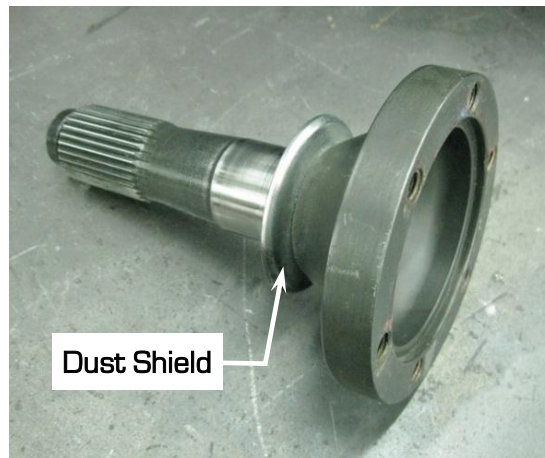

Figure 67 – Stub Axle Shafts

68. In order to install the Detroit Speed stub axles, first remove the stock stub axles from the rear differential. Drain the fluid from the rear differential and remove the rear cover (Figure 68).

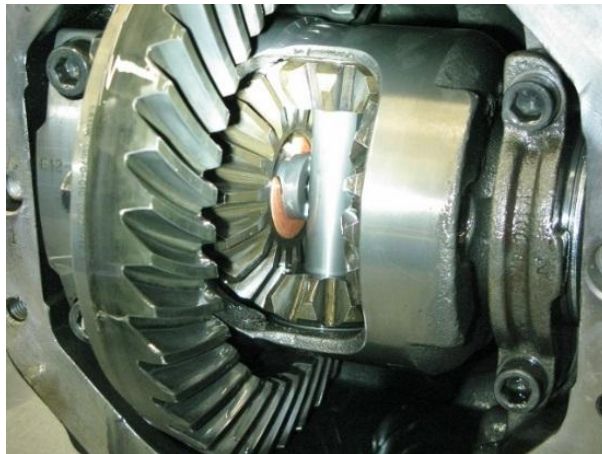

Figure 68 – Remove the Rear Cover

69. Remove the cross shaft bolt pin from the carrier and push the cross shaft out of the carrier (Figure 69). **NOTE:** There is a shim under the pinion gear inside the carrier that the cross shaft goes through (Figure 70). This shim can slide out of alignment or even fall into the carrier. Make sure the shim does not move when the cross shaft is re-installed in step 73.

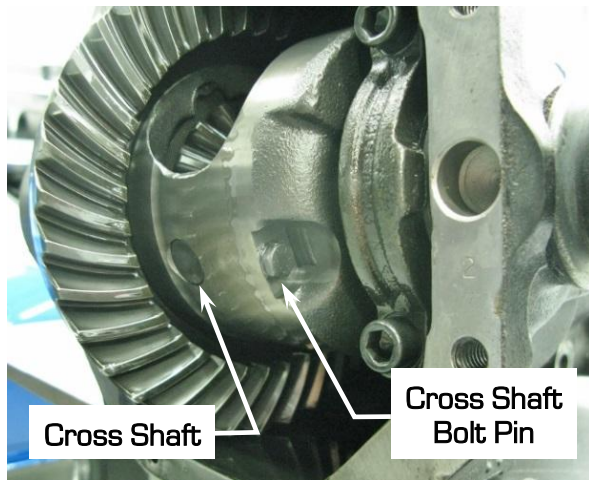

Figure 69 - Cross Shaft & Cross Shaft Bolt Pin

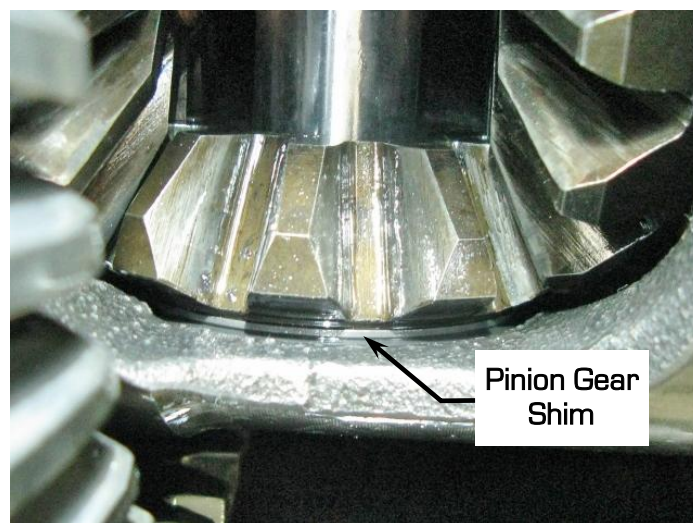

Figure 70 - Pinion Gear Shim

70. With the cross shaft out of the carrier, slide the stub axles into the differential in order to remove the C-clips or snap rings. Figure 71 shows a stock 17-spline stub axle with the snap ring removed. Figure 72 shows the 30-spline stub axle with the C-Clip before removal.

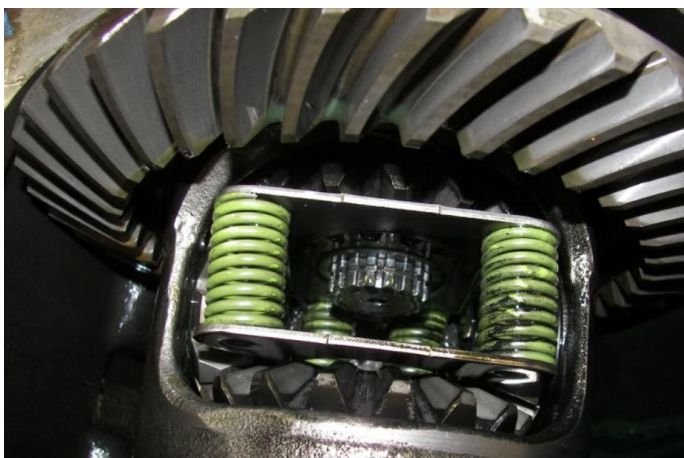

Figure 71 - Remove Snap Rings



Figure 72 - 30-Spline C-clip

71. Slide the stub axles with the dust shields out of the differential (Figure 73). **NOTE:** The stock stub axle ends may be worn and mushroomed over. You may have to tap or hit the stub axles to get them out of the carrier. The dust shields will be replaced as well as the stub axles in this kit.

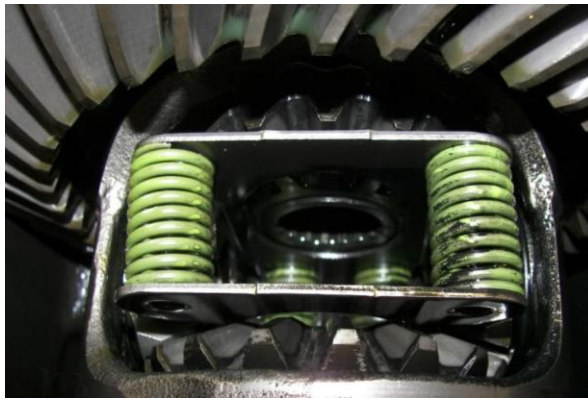

Figure 73 - Remove Stock Stub Axles

72. Slide the Detroit Speed stub axles with the new provided dust shields into the rear differential. Re-install the snap rings or C-clips onto the new stub axles. Verify that they are located in the grooves correctly. Slide them out against the snap rings or C-clips (Figure 74).

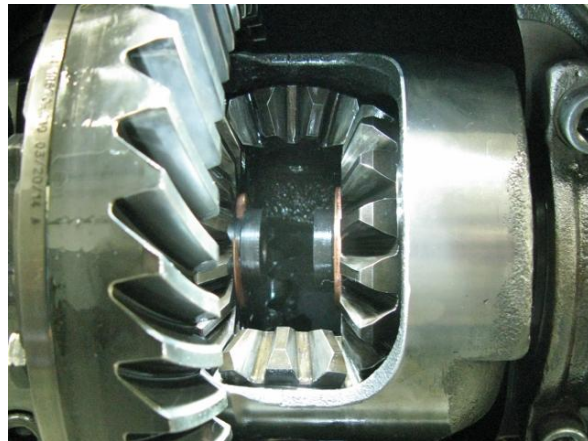

Figure 74 - Install Detroit Speed Stubs Axles

73. Re-install the cross shaft (Figure 75) and verify the alignment shim is in position as noted in Step 68. Re-install the cross shaft pin bolt with high strength red Loctite 262 on the threads and tighten. Re-install the rear cover onto the differential using Ultra Grey RTV silicone and torque the cover bolts to 20 ft.-lbs. Fill the differential with gear oil.



Figure 75 - Install Cross Shaft

74. Install the upper differential bracket assembly to the tapped holes in your rear differential cover using the provided 7/16"-14 x 1"L hex head bolts and washers. Use medium strength blue Loctite 242 on the threads and torque to 50 ft-lbs. (Figure 76). **NOTE:** A stock rear differential is used in the following installation pictures.



Figure 76 - Upper Differential Bracket Assembly

75. Disassemble the IRS upper and lower cradle assemblies from each other by removing the 7/16"-14 hardware. Place the IRS lower cradle assembly next to the rear differential (Figure 77).



Figure 77 - Disassemble IRS Upper & Lower Cradle

76. Install the lower differential bracket assembly to the lower cradle using the provided 1/2"-20 x 3"L hex head bolts, washers and Nylock nuts through the bushing mounts (Figure 78). Use anti-seize on the threads of the bolts. **NOTE:** The bracket must be installed with the pinion offset to the passenger side of the bracket centerline. Leave the hardware loose for now.



Figure 78 - Lower Differential Bracket Assembly

77. Place a block of wood on the cast aluminum cradle. Place the rear differential assembly into the IRS cradle with the back of the differential resting on the block of wood. Install the front of the differential into the lower differential bracket using the provided $7/16$ "-14 x 4-1/4"L hex head bolts, washers and Nylock nuts (Figure 79). **NOTE:** Leave the hardware loose for now.

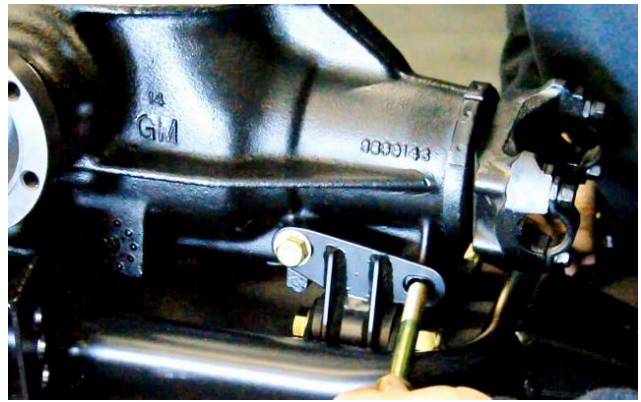
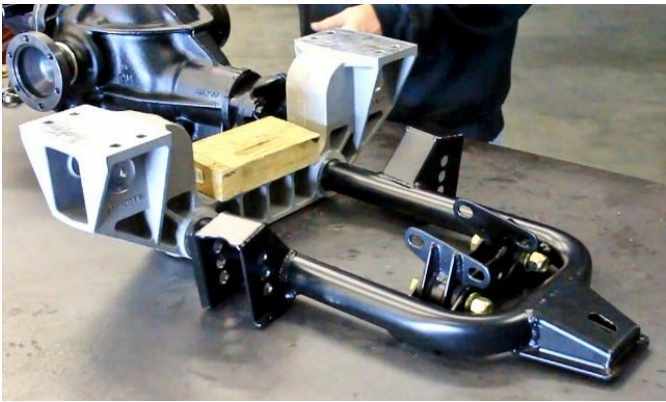

Figure 79 - IRS Lower Cradle/Rear Differential Assembly

NOTE: If you are installing the DECAlink with the body off the chassis, continue onto the next step. If you are installing this kit with the body on the chassis, skip to Step 80.

78. Install the IRS upper cradle assembly to the framerails. Install the provided $1/2$ "-13 x 1-1/4"L flange head bolts using medium strength blue Loctite 242 on the threads, into the nut plates from the bottom side of the framerails (Figure 80).



Figure 80 - Install Upper Cradle Assembly to Frame

79. Install the provided 7/16"-14 x 1"L hex head bolts and washers with medium strength blue Loctite 242 on the threads, into the nut plates from the inside of the framerails (Figure 81). Torque the 7/16"-14 bolts to 50 ft-lbs. and the 1/2"-13 bolts from the previous step to 70 ft-lbs. Continue on to **Step 86**.



Figure 81 - Install Upper Cradle Assembly to Frame

80. Place the provided 7/16"-14 x 3/4"L hex head bolts and washers through the 1-1/4" hole that was drilled in the outside frame rail. (Figure 82).



Figure 82 - Install Crossmember Fasteners

81. Install the IRS upper cradle assembly to the framerails. Install the provided 1/2"-13 x 1-1/4"L flange head bolts with medium strength blue Loctite 242 on the threads, into the nut plates from the bottom side of the framerails (Figure 83). **NOTE:** Make sure the 7/16"-14 bolts that were installed in the previous step pass through the slot on the upper cradle tab that goes against the inside frame rail.



Figure 83 - Install Upper Cradle Assembly to Frame

82. Install the two 1/2"-13 x 1-3/4"L flange head bolts and slotted shims through the IRS upper cradle assembly that are installed at the rear frame crossmember (Figure 84).



Figure 84 - Install Fasteners & Slotted Shims

83. Draw up the IRS upper cradle assembly to the frame by tightening the six 1/2" bolts from the upper cradle to the frame. Torque the six 1/2"-13 bolts from the Steps 81 & 82 to 70 ft-lbs. (Figure 85).



Figure 85 - Torque 1/2"-13 Hardware

84. Install the provided 7/16"-14 flange lock nut on the hardware installed in Step 80. The flange lock nut should tighten against the slotted tab on the IRS cradle crossmember against the inside frameraill. Torque the 7/16"-14 fasteners to 50 ft.-lbs. (Figure 86).



Figure 86 – Torque Inner Frame Rail Fasteners

85. Before the lower cradle can be installed into the vehicle, you will first need to install the driveshaft into the rear differential.

86. Position the IRS lower cradle/differential assembly under the frame using a transmission or floor jack. **NOTE:** If you are installing the DECALink with the body on, make sure the driveshaft is in position before raising the lower cradle into position (Figure 87).



Figure 87 – Install Rear Differential Assembly

87. Center and level the IRS cradle to the frame by using the spherical washers, shims and 5/8"-18 hardware at the lower differential mount (Figure 88).

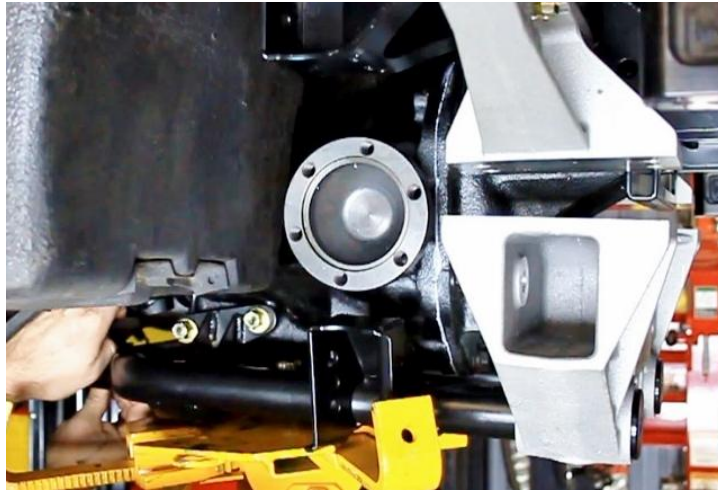

Figure 88 - Install 5/8"-18 Hardware

88. Raise the lower cradle up so the bushing mounts in the differential bracket line up with the bracket in the upper cradle. Install the differential bracket assembly into the IRS upper cradle using the provided 1/2"-20 x 3"L hex head bolts, washers and nuts through the bushing mounts (Fig. 89).



Figure 89 - Install Differential to Upper Cradle

89. Remove the block of wood between the IRS lower cradle and the differential. Torque the 5/8"-18 hardware at the lower differential mount to 150 ft-lbs. (Figure 90).



Figure 90 - Torque Lower Differential Mount

90. Re-assemble the IRS lower and upper cradle together using the 7/16"-14 x 1-1/2" L flange head bolts and flange lock nuts using anti-seize on the threads (Figure 91). Torque to 50 ft-lbs. and remove the floor jack.



Figure 91 - Assemble the IRS Upper and Lower Cradle

91. Torque the 1/2"-20 x 3" L hex head bolts, washers and Nylock nuts in the upper differential bracket assembly to the upper cradle bracket from Step 88 to 70 ft-lbs. (Figure 92).



Figure 92 - Torque Upper Differential Bracket

92. Torque the 1/2"-20 x 3" L hex head bolts, washers and Nylock nuts in the lower differential bracket assembly to 70 ft-lbs. Torque the 7/16"-14 x 4-1/4" L hex head bolts in the differential housing to the mounting bracket to 50 ft-lbs. (Figure 93).

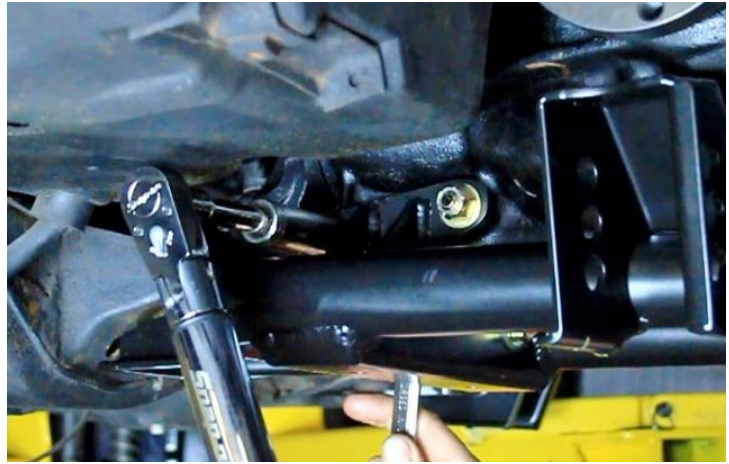
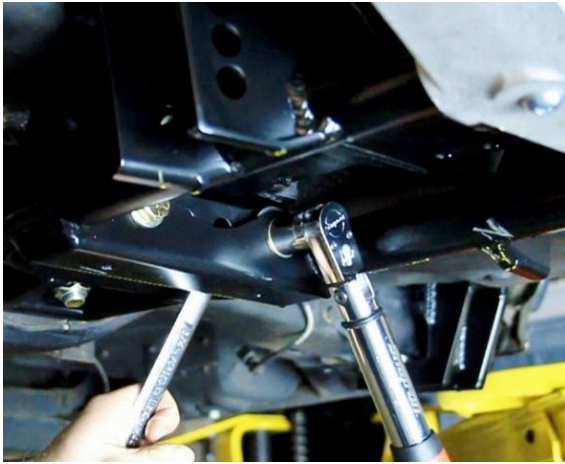

Figure 93 – Torque Lower Differential Bracket

93. Install the upper IRS trailing link assemblies into the trailing link brackets in the framerails. These links will measure 13" from center of bushing to center of bushing. The upper links will be installed into the middle hole in the brackets using the provided M14-2.0 x 120mm flanged head bolts and flange lock nuts (Figure 94). The bolts will need to be installed facing to the inside (i.e. the bolt head is towards the outside). **NOTE:** There are three hole positions in the trailing arm brackets. Detroit Speed recommends using the middle hole for nominal setting. The M14 link hardware will require an 18mm socket/wrench for the bolts and a 21mm socket/wrench for the lock nuts.



Figure 94 – Install the IRS Lower Trailing Links

94. Install the lower IRS trailing link assemblies into the trailing link brackets. These links will measure 13" from center of bushing to center of bushing. The lower links will be installed into the middle hole in the brackets using the provided M14-2.0 x 80mm flanged head bolts and flange lock nuts (Figure 95). The bolts will need to be installed facing to the inside (i.e. the bolt head is towards the outside). **NOTE:** There are three hole positions in the trailing arm brackets. Detroit Speed recommends using the middle hole for nominal setting. Torque the M14 bolts in the upper and lower trailing link assemblies to 120 ft-lbs.



Figure 95 – Install the IRS Lower Trailing Links

95. Torque all 7/16"-14 trailing arm bracket bolts to 40 ft-lbs. (Figure 96).



Figure 96 – Trailing Link Bracket

96. Next, install the upper IRS lateral link assemblies along with the IRS cradle tie braces into the upper cradle crossmember using the provided M14-2.0 x 80mm flanged head bolts. These links will measure 15" from center of bushing to center of bushing. The bolts will need to be installed facing forward (i.e. the bolt head is towards the rear). Install the IRS cradle tie braces onto the threads of the upper IRS lateral link bolts (Figure 97). Do not torque the M14 bolts at this time. **NOTE:** Detroit Speed recommends using a tie wrap to hold the upper lateral link to the cradle crossmember. This will temporarily keep it out of the way when you install the uprights later.



Figure 97 – Install Upper Lateral Link & Tie Braces

97. Install the lower IRS lateral link assemblies into the lower cradle assembly using the provided M14-2.0 x 80mm flanged head bolts. These links will have the clevis on one end to attach to the upright and will measure 16" from center of bushing to center of clevis hole. The bolts will need to be installed facing forward (i.e. the bolt head is towards the rear). Swing the IRS cradle tie braces in position so the M14-2.0 bolts go through the lower section of the IRS cradle tie braces and tighten with the provided M14-2.0 flange lock nuts (Figure 98 on the next page). Torque the upper and lower lateral link M14 bolts to 120 ft-lbs. **NOTE:** There are three hole positions in the cradle tie braces. Detroit Speed recommends using the middle hole for nominal setting.



Figure 98 – Install Lower Lateral Links

98. Install the IRS toe link assemblies into the lower cradle assembly using the provided M14-2.0 x 90mm flanged head bolts and flange lock nuts (Figure 99). These links will measure 17-1/4" from center of bushing to center of bushing. The bolts will need to be installed facing forward (i.e. the bolt head is towards the rear). Torque the M14 bolts to 120 ft-lbs.



Figure 99 - Install Toe Link Assemblies

99. Next, install the sway bar onto the frame bracket spacers. Start by using the provided super grease, lubricate the inside of the provided 3/4" ID polyurethane bushings and install them onto the sway bar. Position the sway bar to the frame bracket spacers and place the sway bar mount bushing brackets over the bushings. Install the sway bar assembly to the frame bracket spacers with the provided 3/8"-16 x 3/4" L hex head bolts and washers (Figure 100). Use medium strength blue Loctite 242 on the threads of the bolts and torque to 35 ft-lbs.



Figure 100 - Install Sway Bar

100. Center the sway bar from side to side in the frame. Next, install the provided 3/4" sway bar split lock collars. Loosen both Allen screws in the lock collars. Apply medium strength blue Loctite 242 on the threads and position the clamps onto the sway bar up against the bushings. With the heads of the bolts accessible from the bottom, torque the Allen screws to 12 ft-lbs. **NOTE:** Be sure that the groove in the clamps are installed so that it points to the outside of the vehicle and that the two clamps match on either side (Figure 101).



Figure 101 – Center Sway Bar and Install Split Lock Collars

101. Install the inner CV joint on the rear half-shafts to the stub axles in the rear differential using the provided M10-1.5 x 60mm 12 point bolts (Figure 102). Use high strength red Loctite 262 on the threads and torque to 57 ft-lbs.



Figure 102 – Install Inner CV Joint to Stub Axle

102. Position the rear upright assemblies in place and install the outer CV joint into the rear hubs. Install the hub nut onto the rear half-shafts, do not torque at this time. **NOTE:** Use a jack stand underneath the hubs to help position the uprights in place if necessary (Figure 103).

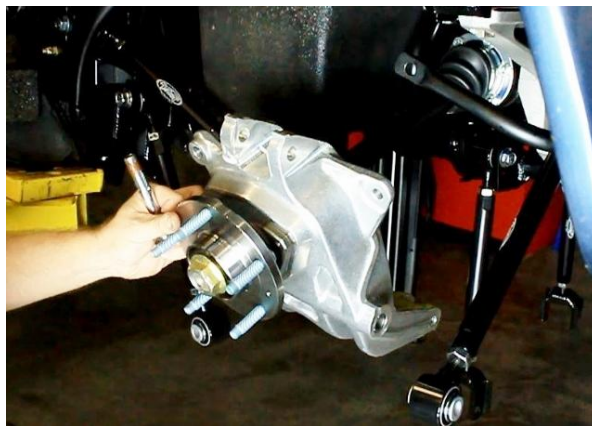

Figure 103 – Install Rear Upright to Outer CV Joint

103. Remove the tie wrap from the upper IRS lateral links and install them to the top of the uprights using the provided M14-2.0 x 100mm flange head bolts and flange lock nuts. Install the lower IRS lateral link clevis to the bottom of the uprights using the provided M14-2.0 x 80mm flange head bolts and flange lock nuts (Figure 104). Torque the M14 upright bolts to 120 ft-lbs.



Figure 104 - Attach Lateral Links to Upright

104. Install the lower IRS trailing arm links to the inside of the uprights first, followed by the upper trailing arm links using the provided M14-2.0 x 70mm flange head bolts (Figure 105). Use medium strength blue Loctite 242 on the threads and tighten.



Figure 105 - Install Upper & Lower Trailing Links

105. Install the IRS toe link assemblies to the back of the uprights using the provided M14-2.0 x 70mm flange head bolts (Figure 106). Use medium strength blue Loctite 242 on the threads. Torque all M14 upright bolts to 120 ft-lbs.



Figure 106 - Install Toe Links

106. Install the sway bar end link assemblies onto the sway bar using the provided M12 x1.75 flange lock nut. The body of the end link should be on the outside of the sway bar. Install the sway

bar end links into the uprights using the provided M12 x 1.75 flange lock nut (Figure 107). Hold the endlink with a wrench and torque the flange nuts to 45 ft-lbs.



Figure 107 - Install Sway Bar End Link Assemblies

107. Next, it is necessary to build each coilover shock and spring assembly before installing them into the vehicle. Remove the spring seat from the retaining ring using a rubber hammer and moving it down off the shock mount (Figure 108). Remove the retaining ring from the shock mount and pass the spring seat over the shock mount (Figure 109).



Figure 108 - Removing the Spring Seat



Figure 109 - Spring Seat & Retaining Ring

108. Thread the spanner nut all the way to the bottom of the coilover shock and install the Torrington bearing set (Figure 110) on each shock by installing one thrust washer, followed by the roller bearing and then another thrust washer. Detroit Speed recommends using high pressure grease between the roller bearing and thrust washers.



Figure 110 - Torrington Bearing Set

109. Slide the coilover spring over the shock mount. Install the spring seat back over the shock mount and re-install the retaining ring back onto the shock mount. Press the spring seat up onto the retaining ring so it locks in place.
110. Position the body side of the shock up into the crossmember. **NOTE:** The remote canister hose on the shock body should be pointed to the outboard side of the vehicle. If you have adjustable shocks, the adjustment window should be pointing to the center of the vehicle.
111. Install the provided 3/4" OD x 7/8" L upper shock spacer onto the provided 1/2"-20 x 3" L hex head bolt. Apply medium strength blue Loctite 242 to the threads. Install the bolt and spacer through the front of the crossmember mounting hole, through the monoball of the shock, and into the crossmember (Figure 111). Do not torque at this time.



Figure 111 - Install Upper Shock Bolt & Spacer

112. Install the provided tapered spacers onto both sides of the monoball on the shaft side of the shock. Position the shock up to the bottom of the upright. Install the provided 1/2"-13 x 3"L flange head bolt through the upright so the bolt is facing forward (i.e. the bolt head is towards the rear). The bolt will go through the upright, the tapered spacers, monoball, and through the other side of the upright. Use anti-seize on the threads of the bolt and install the provided 1/2"-13 flanged lock nut (Figure 112). Torque both the upper and lower shock bolts to 60 ft-lbs.



Figure 112 – Install Lower Shock Bolt & Tapered Spacers

113. Tighten the upright hub nut to the outer CV joint using a 1-5/16" socket. Use high strength red Loctite 262 on the threads and torque to 140 ft-lbs. (Figure 113).



Figure 113 – Torque Outer CV Joint

114. If you have followed the body on installation, install the provided 1-1/4" recessed button plug in the outer frame rail access hole (Figure 114).



Figure 114 – Install Recessed Plug

115. Test fit your rear brake caliper brackets on the rear uprights as the uprights may need to be trimmed to clearance the brake brackets (Figure 115).

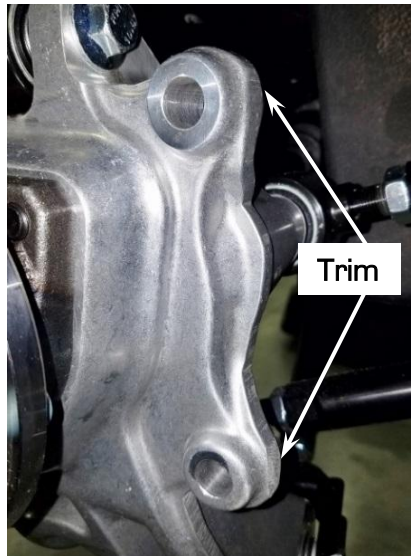

Figure 115 – Trim Upright

116. The rear suspension is assembled at this point. Figure 116 shows a completed installation. Double check to make sure that all installed components are tight and torqued correctly.



Figure 116 – Final Assembly

117. Now that all suspension components have been installed and once the vehicle is assembled, it is time to set vehicle ride height. Before adjusting the ride height, clean the threads of the shock. Once the threads are clean, DSE recommends applying dry bicycle chain lube to the threads of the shock body before adjusting the spanner nut and compressing the coilover spring. Allow the chain lube to dry before adjusting the spanner nut. If you have the non-adjustable shocks, the spanner nut has a soft tip set screw that will need to be tightened before the vehicle is driven.

NOTE: Detroit Speed does include a Spanner Tool (P/N: 031060DS) to adjust ride height however if you have the adjustable coilover shocks, DSE does offer an Adjustment Tool available as P/N: 031061DS if needed (Figure 117).



Figure 117 – Detroit Speed Spanner & Adjustment Tools

118. If the Single Adjustable Remote Canister Coilovers or the Double Adjustable Remote Canister Coilovers were purchased as an upgrade, refer to the following information for adjustment procedures.

Detroit Speed Single Adjustable Shocks w/Remote Canisters

To change from the recommended “Detroit Tuned” valving, adjustments can be made independently to the rebound setting. The rebound is controlled by the sweeper at the upper shock mount (Shock is mounted body side up). The sweeper rotates clockwise (+) to increase the damping and counterclockwise (-) to decrease the damping (Figure 118a on the next page).

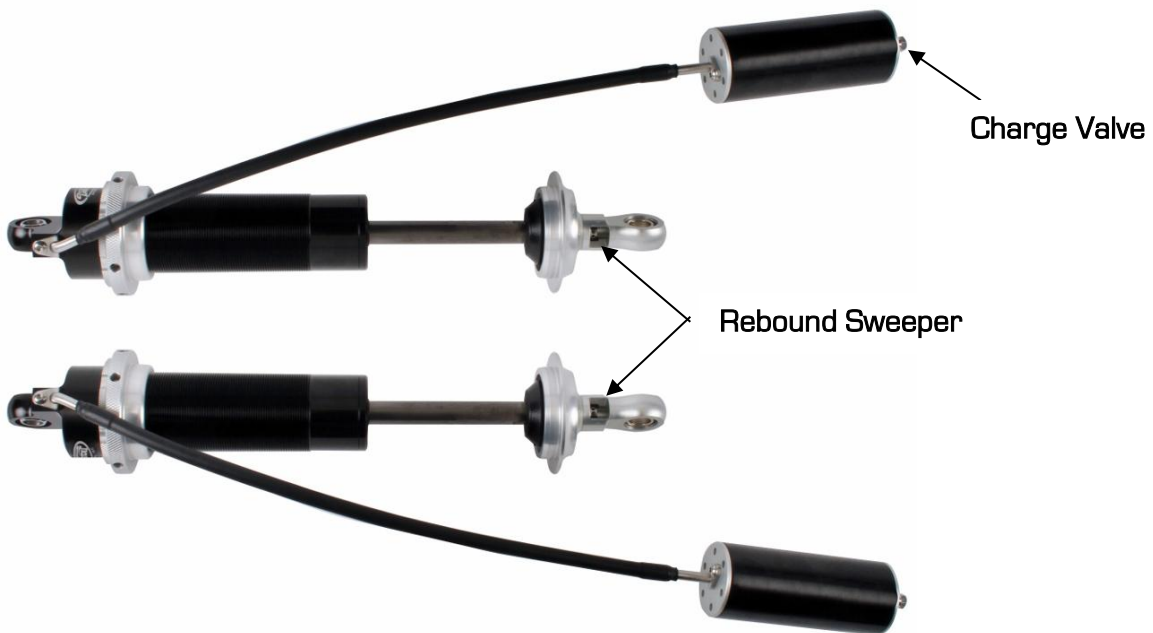

Figure 118a- Detroit Speed Single Adjustable Shock

To return to the Detroit Speed recommended settings, turn the sweeper clockwise (+) to full damping. Once at full damping, turn counterclockwise (-) to reach the recommended settings. Refer to Figure 118b for the rebound settings.

Rebound (Sweeper)..... 15 Sweeps (counterclockwise, -)

Figure 118b – Detroit Speed Recommended Settings

Adjuster Operation

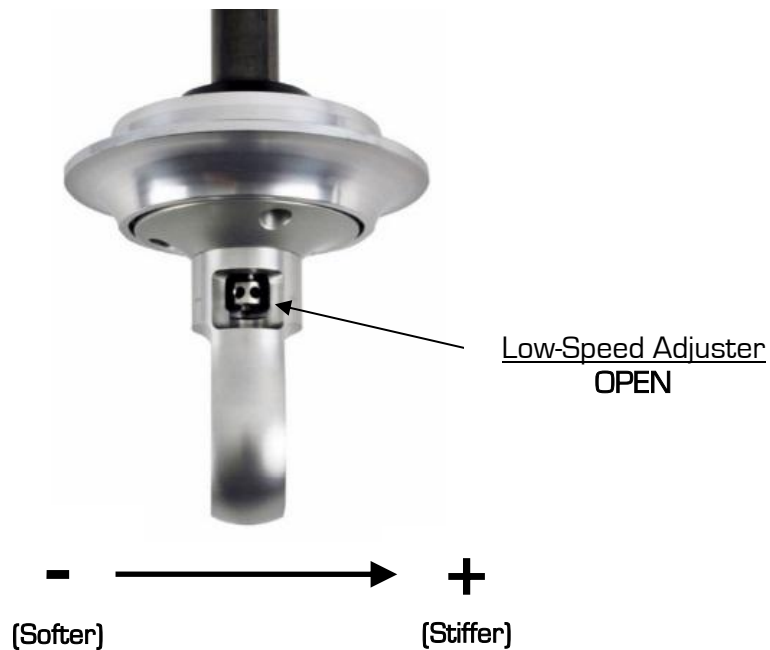

- **Adjuster (60-64 Sweeps)**

The low-speed adjuster is a “clicker” style adjuster meaning that its adjustment is measured by detents located inside the sweeper. There are 16 sweeps per 1 revolution of the sweeper. It uses a right-hand thread in its operation which means as you increase low-speed, the adjuster will move up on the eyelet. The recommended change for an adjustment is 8 clicks at a time. The low-speed adjuster’s reference position is **full stiff** (closed, or all the way up) and referred to -0 (-0 = full stiff, -64 = full soft).

- **Tuning Notes**

- **Racetrack**
 - For more grip, soften the damping.
 - For increased platform control, stiffen the damping.
- **Street**
 - For a more comfortable ride, soften the damping

***DO NOT FORCE KNOB WHEN IT STOPS TURNING, YOU MAY DAMAGE THE ADJUSTER AND INTERNAL HARDWARE**

Detroit Speed Double Adjustable Shocks w/Remote Canisters

To change from the recommended “Detroit Tuned” valving, adjustments can be made independently to both the high and low speed settings. The rebound is controlled by the sweepers at the upper shock mount. The sweepers rotate clockwise (+) to increase the damping and counterclockwise (-) to decrease the damping. Refer to Figure 119a.



Figure 119a - Detroit Speed Double Adjustable Shock w/Remote Canister

When adjusting the low speed rebound start at full (+) position, when adjusting the high speed rebound start at full (-) position. To return to the Detroit Speed recommended settings turn the sweeper clockwise (+) to full damping for the low speed setting, and counterclockwise (-) to full damping for the high speed setting. Once at full damping, turn counterclockwise (-) for the low speed setting, and clockwise (+) for the high speed setting to reach the recommended settings. Refer to Figure 119b for recommended settings.

- Low Speed Rebound (Sweeper)..... 20 sweeps (counterclockwise)(-)
- High Speed Rebound (Sweeper)..... 2 sweeps (clockwise)(+)

Figure 119b - Detroit Speed Recommended Settings

Adjuster Operation

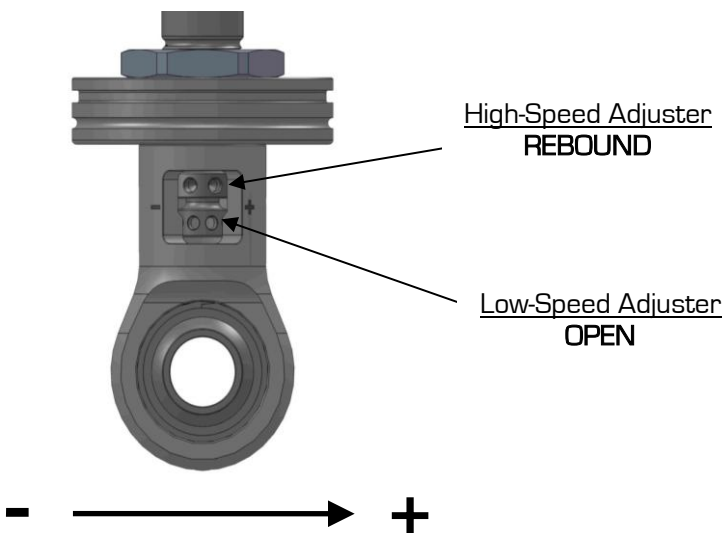

- **High-Speed Adjuster (12 Sweeps)**

The high-speed adjuster is a “sweep” style adjuster meaning that its adjustment is measured by the location of the adjuster in the eyelet window. It uses a left-hand thread in its operation which means; as you increase high-speed, the adjuster will move down in the window*. The high-speed adjuster’s reference position is **full soft** and referred to as +0 (+0 = full soft, +12 = full stiff).

- **Low-Speed Adjuster (25 Clicks)**

The low-speed adjuster is a “clicker” style adjuster meaning that its adjustment is measured by detent grooves located inside the high-speed shaft. It uses a right-hand thread in its operation which means; as you increase low-speed, the adjuster will move up in the window. The low-speed adjuster’s reference position is **full stiff** and referred to -0 (-0 = full stiff, -25 = full soft).

**The low-speed adjustment does not change when adjusting the high-speed.*

To aid in the installation of the reservoirs, we also offer a set of billet aluminum remote canister mounts. The canister mounts are available exclusively through Detroit Speed, P/N: 032108DS (Figure 120).



Figure 120 – Billet Aluminum Remote Canister Mounts

Have a professional alignment completed following the specifications given in the chart on page. 2.

If you have any questions before or during the installation of this product, please contact Detroit Speed at tech@detroitsspeed.com or 704.662.3272

Legal Disclaimer: *Detroit Speed is not liable for personal, property, legal, or financial damages from the use or misuse of any product we sell. The purchaser is solely responsible for the safety and performance of these products. No warranty is expressed or implied.*