

Window Winders



Whitco[®]
SECURING YOUR HOME™

10YEAR MECHANICAL WARRANTY

whitco.com.au

Contents



CYL4® Lockable

Window Winder

page 1



5 Disc Lockable

Window Winder

page 3



Non-locking Chainwinder

Window Winder

page 5



Accessories

Window Winder

page 7



Roto Operator

Window Winder

page 8

Overview



CYL4® is a patented innovation that allows ASSA ABLOY window locks and patio bolts to be keyed to door locks that use the most common key type (C4), thus providing customers with the added convenience of having to use only one key around the home.

Most Australian door locks are operated by a C4 key. Traditional window locks are incompatible with a C4 key. Therefore homeowners are required to carry at least one key for their door locks, and a different key (or keys) for their window locks.

The introduction of ASSA ABLOY's unique CYL4® technology has revolutionised home locking security. Our CYL4® window lock and chainwinder ranges incorporate the patented CYL4® cylinder, which is quickly and easily keyed alike to your customer's 5 pin C4 door key.

From...



To...



The ASSA ABLOY Key Gauge, provided in the CYL4® Keying Kit, allows fast and accurate determination of the key code.

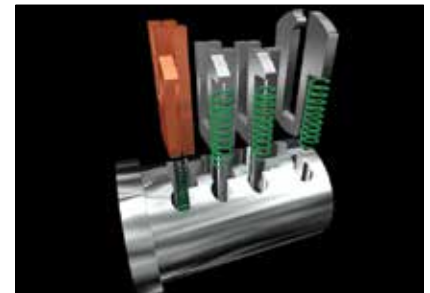

The patented CYL4® cylinder has been designed to retain its wafers when the key is removed. This makes re-keying the CYL4® cylinder quick and easy for retailers and locksmiths alike.

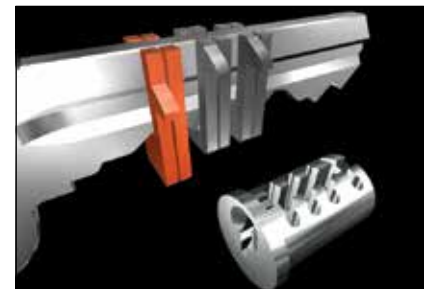

There are 10 CYL4® wafers numbered 0-9, that cover the 10 depths of a C4 key. Six wafers are arranged in pairs to match the first 3 cuts of the customer's key.



Using the CYL4® Keying Kit, you can re-key any ASSA ABLOY CYL4® window lock or patio bolt to the customer's C4 key in just a few minutes. EASY!

CYL4® Lockable Chainwinder

Application / Description

Chain type operator provides CYL4® locking for awning windows.

Features and Specifications

- CYL4® One Key Security – Can be matched to most door and window locks for one key convenience
- Suits aluminium or timber awning windows with butt or hook hinges, or non friction stays
- Smooth operation
- Through flyscreen operation
- Push button to lock, key to unlock
- Less than 1mm between locking points
- Maximum opening 300mm, 19 handle turns to fully open
- Can be wound closed when locked
- Retrofits existing MK7 and MK8 Whitco chainwinder models
- Foldable knob in handle reduces width preventing damage and interference with blinds
- Zinc diecast body and mechanism, passivated zinc steel base plate and passivated zinc steel chain
- Corrosion resistant version available with stainless steel chain and stainless steel base plate
- Retail pack has printed instructions on sealed poly bag, opening restriction clip, standard and one-way fixing screws and sash security fixing brackets
- Exceeds the requirements of Australian window lock standard AS4145.3 – 2001 level DW2SW2
- The chain can be restricted to either 100mm or 150mm opening length via fitment of a restrictor clip in the base of the chain winder mechanism. The fitment of the restrictor clip assists the window to comply with Building Code Australia requirements D2.24 Protection of Operable Windows
- Available in retail and trade packs

Keying

- CYL4® cylinder - Can be Keyed Alike to all door locks that use a 5 pin key with a C4 profile, and to CYL4® window locks
- Two Whitco keys included



Awning

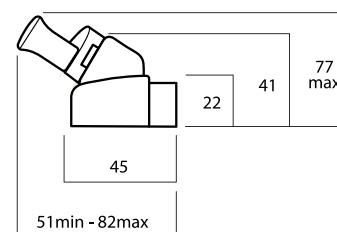
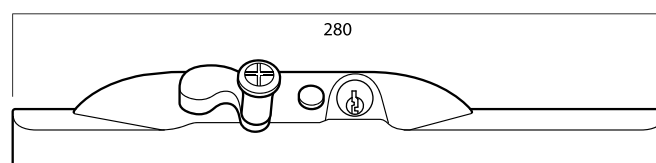

CYL4® Lockable Chainwinder

Accessories

Brackets, Handle and Accessory Pack

See Accessories section.

Performance

Window size guidelines

Maximum weight of sash 15kg with 300mm opening
Contact customer service for more information.

Recommended maximum sash width of 900mm
to ensure adequate weather sealing of the window
system.

Corrosion

Minimal effect to full exposure to 96 hours Neutral
Salt Spray mounted on powder coated Aluminium
sill section.

Standard Finishes

Silver	11
Brown	13
Pottery	14
White	16
Black	17
Primrose	19
Magnolia	24
Stone Beige	28
White Birch	41

Non Standard Finishes

Other polyester powder coat finishes available on
application.

Ordering – CYL4® cylinder

Retail Pack

Cyl4 push to lock, 300mm mild steel chain	W3801••
---	---------

Trade Pack

Cyl4 push to lock, 300mm mild steel chain	W3802••C4
Cyl4 push to lock, 300mm stainless steel chain	W3803••C4

•• Denotes finish. See Standard Finishes table below.

Special Keying

Special keying options are available in trade pack.
Please contact Customer Service for ordering information.

5 Disc Lockable Chainwinder

Application / Description

Chain type operator provides locking for awning windows.

Features and Specifications

- Suits aluminium or timber awning windows with butt or hook hinges, or non friction stays
- Smooth operation
- Through flyscreen operation
- Push button to lock, key to unlock
- Less than 1mm between locking points
- Maximum opening 300mm, 19 handle turns to fully open
- Can be wound closed when locked
- Retrofits existing MK7 and MK8 Whitco chainwinder models
- Foldable knob in handle reduces width preventing damage and interference with blinds
- Zinc diecast body and mechanism, passivated zinc steel base plate and passivated zinc steel chain
- Corrosion resistant version available with stainless steel chain and stainless steel base plate
- Exceeds the requirements of Australian window lock standard AS4145.3 – 2001 level DW2SW2K1
- The chain can be restricted to either 100mm or 150mm opening length via fitment of a restrictor clip in the base of the chain winder mechanism. The fitment of the restrictor clip assists the window to comply with Building Code Australia requirements D2.24 Protection of Operable Windows
- Available in retail and trade packs

Keying

- 5 disc wafer cylinder – Can be Keyed Alike to other Whitco 5 disc products
- Two Whitco keys included



Aluminium

Timber



Awning

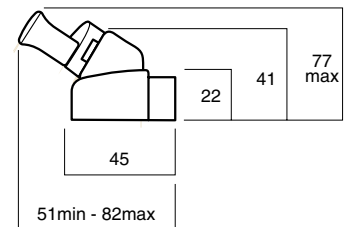
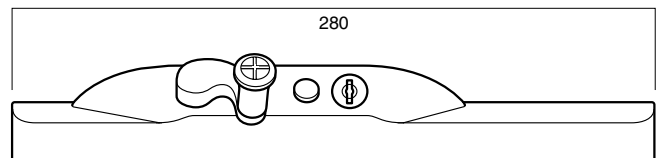

5 Disc Lockable Chainwinder

Accessories

Brackets, Handle and Accessory Pack

See Accessories section.

Performance

Window size guidelines

Maximum weight of sash 15kg with 300mm opening
Contact customer service for more information.

Recommended maximum sash width of 900mm
to ensure adequate weather sealing of the window
system.

Corrosion

Minimal effect to full exposure to 96 hours Neutral
Salt Spray mounted on powder coated Aluminium
sill section.

Standard Finishes

Silver	11
Brown	13
Pottery	14
White	16
Black	17
Primrose	19
Magnolia	24
Stone Beige	28
White Birch	41

Non Standard Finishes

Other polyester powder coat finishes available on
application.

Ordering - 5 disc wafer cylinder

Residential pack

5 disc cyl, push to lock, 300mm mild steel chain	W3801••D5K
--	------------

Trade Pack

5 disc cyl, push to lock, 300mm mild steel chain	W3802••
--	---------

5 disc cyl, push to lock, 300mm stainless steel chain	W3803••
---	---------

•• Denotes finish. See Standard Finished table below.

Special Keying

Special keying options are available in trade pack.
Please contact Customer Service for ordering information.

Non Locking Chainwinder

Application / Description

Chain type operator for awning windows.

Features and Specifications

- Suits aluminium or timber awning windows with butt or hook hinges, or non friction stays
- Smooth operation
- Through flyscreen operation
- Maximum opening 300mm, 19 handle turns to fully open
- Foldable knob in handle reduces width preventing damage and interference with blinds
- Corrosion resistant version available with stainless steel chain and stainless steel base plate
- Retrofits existing MK7 and MK8 Whitco chainwinder models
- Retail pack has printed instructions on sealed poly bag, opening restriction clip, standard and one-way fixing screws
- The chain can be restricted to either 100mm or 150mm opening length via fitment of a restrictor clip in the base of the chain winder mechanism. The fitment of the restrictor clip assists the window to comply with Building Code Australia requirements D2.24 Protection of Operable Windows
- Available in retail and trade packs

Keying

Not keyed



Aluminium Timber

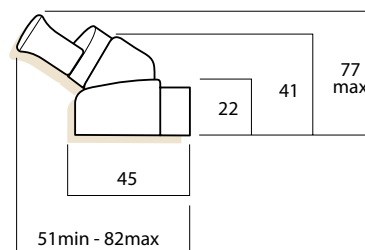
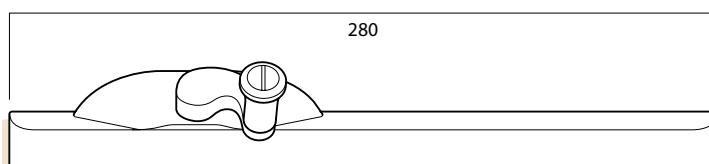

Non Locking Chainwinder

Accessories

Brackets, Handle and Accessory Pack

See Accessories section.

Performance

Window size guidelines

Maximum weight of sash 15 kg with 300 mm opening.
Contact customer service for more information.

Recommended maximum sash width of 900 mm to ensure adequate weather sealing of the window system.
Contact customer service for more information.

Corrosion

Minimal effect to full exposure to 96 hours Neutral Salt Spray mounted on powder coated Aluminium sill section.

Standard Finishes	
Silver	11
Brown	13
Pottery	14
White	16
Black	17
Primrose	19
Magnolia	24
Stone Beige	28
White Birch	41

Non Standard Finishes

Other polyester powder coat finishes available on application.

Ordering

Residential Pack

300mm mild steel chain W3701••

Trade Pack

300mm mild steel chain W3702••

300mm stainless steel chain W3703••

•• Denotes finish. See Standard Finished table for list of available colours.

Accessories

Mounting Brackets

To fix Whitco Window Winder to aluminium sill sections.

Front Fix

Zinc diecast - **W3513**••

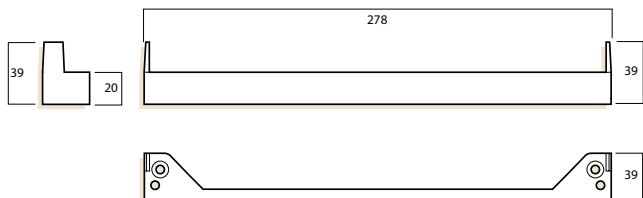

Boral

Zinc diecast to suit the Boral Window sill section - **W3515**••

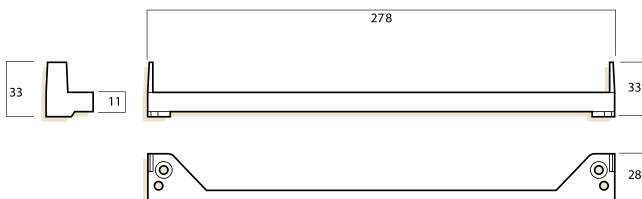

Alcan

Zinc diecast to suit Alcan sill section - **W3516**••

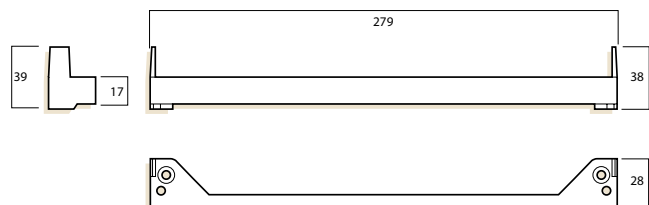

Airlite

Zinc diecast to suit the Airlite sill section - **W3520**••

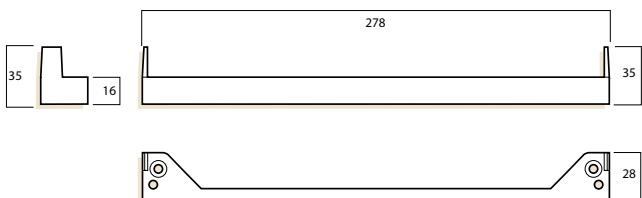

Window Winder Accessories Pack

Packet of Standard and one-way sill screws, sash fixing screws, hooded sash bracket, diecast Security Sash fixing plate - **W383417**

Window Winder Handle

Replacement Whitco Window Winder handle - **W3424**••

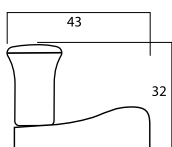

Opening Restriction Clip

Inserted into chain to restrict opening to 100mm or 150mm - **W341001** single pack or **W341010** 10 pack



Roto Operator

Application

Solid arm operator for casement windows.

Features and Specifications

- Suits steel or aluminium casement windows with butt hinges or non friction stays
- Smooth operation
- Through flyscreen operation
- Seven handle turns to fully open
- Zinc die cast body with steel arm
- Durable Stainless Steel slide (sold separately)
- Available in Trade Pack only
- Available in Silver finish



Steel



Trade Pack Only

Right Hand Roto Operator	W330311
Left Hand Roto Operator	W330411
Stainless Steel Slide	W331304

Accessories Included

Mounting Tab x 2



Countersunk Screws x4



Dome head screws x 2

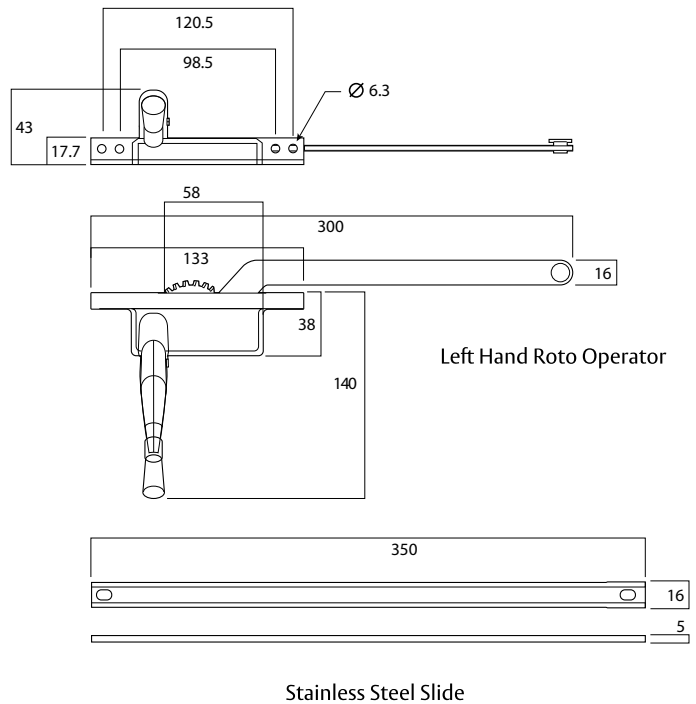

Ordering

Right Hand Roto Operator

W330311

Left Hand Roto Operator

W330411



Stainless Steel Slide

W331304



Whitco[®]

Whitco protects millions of Australian homes and offers the largest range of security and hardware products for residential doors and windows in Australia. With our proud heritage, and by offering a wide variety of locks at affordable prices, Whitco has become one of Australia's most trusted brands.

The Whitco brand is an integral part of ASSA ABLOY Australia Pty Limited, the market leader in the lock and security products industry in Australia.

ASSA ABLOY

ASSA ABLOY is the global leader in door opening solutions, dedicated to satisfying end-user needs for security, safety and convenience.

ASSA ABLOY is represented in all major regions, in both mature and emerging markets, with leading positions in Australia, Europe and North America.

As the world's leading lock group, ASSA ABLOY offers a more complete product range of door opening solutions than any other company in the market.

ASSA ABLOY Australia Pty Ltd
235 Huntingdale Road
Oakleigh, Victoria, 3166
Australia

1300 LOCK UP (1300 562 587)
whitco.com.au

ASSA ABLOY New Zealand Ltd
6 Armstrong Road
Albany, Auckland, 0632
New Zealand

info.nz@assaabloy.com
Telephone +64 9415 7111
assaabloy.co.nz

An ASSA ABLOY Group brand

Disclaimer

Whilst every effort has been made to ensure that the information (including product images and drawings) contained in this brochure is accurate at the time of publication, ASSA ABLOY Australia Pty Limited ("ASSA ABLOY") recommends that you consult ASSA ABLOY or its agents prior to placing an order to ascertain current information on specific products, as ASSA ABLOY reserves the right to make changes without notice. ASSA ABLOY will not be liable for any injury, loss or damage whatsoever, arising from any errors or omissions in the information contained in the brochure or arising from the use or application of the information contained herein. © 2018 copyright by ASSA ABLOY All rights reserved