

















SHUT OFF VALVE BIG GUN (Pg. 1 of 2)

#	DESCRIPTION	PART #
	SHUTOFF VALVE, BIG GUN, VALVE ONLY (DOES NOT INCLUDE #1, 2, 3, 6, 7, 29, NOZZLE OR NOZZLE HOLDER)	66EVD-BG
	BIG GUN KIT, ALLOWS 66EVD-BG TO BE USED WITH 1-1/4" NOZZLES AND NOZZLE HOLDERS (INCLUDES #1, 2, 3, 4, 5, 6 & 7)	66EVD-BG-KIT
	NOZZLE COUPLING, BIG GUN	66NCNV
	RUBBER WASHER, LARGE, BIG GUN	130112
	HARDENED SPACER, BIG GUN	66HS
	RUBBER LINER, 3/4" & 1" HOSE	800-236
	RUBBER O-RING	66RR
	HARDENED INLET ASSEMBLY, 1-1/4" NPSM, BIG GUN	66HI
	RUBBER WASHER, MEDIUM, BIG GUN	66RW-BG
	PLUG, URETHANE, BIG GUN	66VW
	WASHER, STEEL	66EVST-BG
	LOCK NUT, BIG GUN	805-533
	SOCKET HEAD SCREW	100-041
	SHUTOFF ARM	800-218
	SCREW	66CHW
	NOZZLE WASHER, TYPE 1	100-134

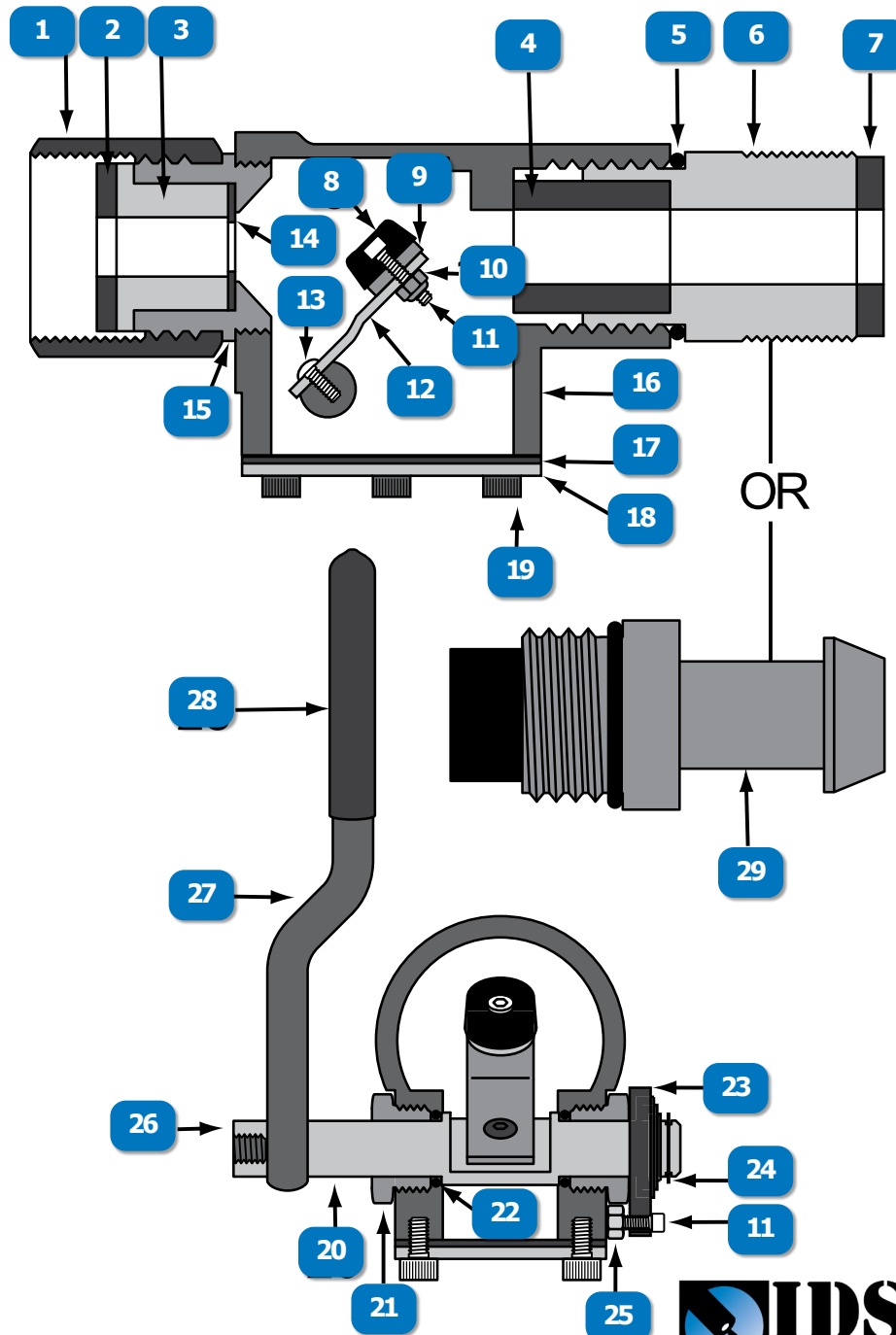

www.idsblast.com
 (317) 545-0665 • (800) 800-0665
 2717 Tobey Dr. Indianapolis, IN 46219

SHUT OFF VALVE BIG GUN (Pg. 2 of 2)

#	DESCRIPTION	PART #
15	INSERT, THREADED VALVE	100-018
16	VALVE BODY	66EVG
17	VALVE COVER	100-170
18	SOCKET HEAD CAP SCREW	805-531
19	VALVE SPINDLE	100-070
20	SPINDLE BUSHING, BRASS	66TB
21	SPINDLE O-RING	15-30-O
22	TORSION SPRING	66VSS
23	SPINDLE E-CLIP	800-149
24	SPRING BOLT NUT	804-322
25	SPINDLE SET SCREW	800-217
26	VALVE HANDLE W/GRIP	66VHD
27	HANDLE GRIP	800-338
28	HOSE END CPLG, 3/4" ID HOSE, INCLUDES O-RING & RUBBER LINER	3-66HE
29	HOSE END CPLG, 1" ID HOSE, INCLUDES O-RING & RUBBER LINER	4-66HE

