

General Information

Bullard's GR50 Series airline respirators, when properly used, provide a continuous flow of air from a remote air source, through a patented air delivery system (U.S. Patent 4,484,575), to the respirator wearer. GR50 Series respirators offer protection from airborne contaminants that are not immediately dangerous to life or health (IDLH), or that do not exceed concentrations allowed by applicable OSHA, MSHA, EPA, NIOSH or ACGIH regulations and recommendations, or any other applicable regulations.

GR50 Series airline respirators are approved by NIOSH (TC-19C-329, Type C) to provide respiratory protection in grinding operations and other such general purpose applications. The GR50 is NOT intended for use in any abrasive blasting operation.

GR50 Series respirators are compatible with breathing air sources such as breathing air compressors or Bullard Free-Air[®] pumps. Bullard offers the appropriate approved breathing tube assembly and air supply hose to connect the GR50 Series respirator to these breathing air sources.

GR50 Series respirators are approved by NIOSH for use with optional Bullard climate control devices.

The GRH Hood of the GR50 Series can also be configured for use with the Bullard EVA PAPR. Refer to the EVA Manual for details.



Type C Continuous-Flow Class

NIOSH Approval No. TC-19C-329

Not approved for abrasive blasting.

Read all instructions and warnings before using this respirator. Save this manual for future reference.

Table of Contents

Approval Label	1,2	GR50 Respirator Use	15,16
General Information	3	Inspection, Cleaning and Storage	17,18
Component Concept.....	4, 5	Parts and Accessories for GR50 Series Airline Respirators	19-22
Warnings.....	6, 7	Return Authorizations	23
Operations.....	8-10		
GR50 Respirator Assembly	11-14		

Component Concept

Bullard GR50 Series airline respirators consist of four components (Figure 1). All must be present and properly assembled to constitute a complete NIOSH-approved respirator.

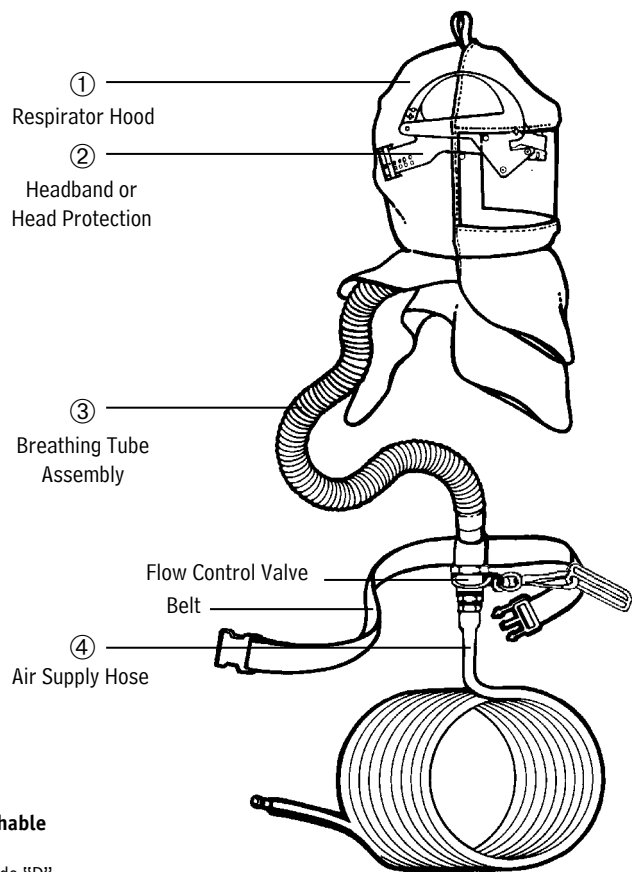

Figure 1

**Clean Breathable
Air Source**
Supplying Grade "D"
or Higher Air Quality (See Breathing
Air Requirements on page 7)

▲ WARNING

Failure to use complete NIOSH-approved Bullard components and replacement parts voids approval of entire assembly. Basic parts are listed on the NIOSH Approval Label on page 1.

Component Concept (continued)

- 1. Respirator Hood**
- 2. Headband or head protection**
- 3. Breathing tube assembly:** Connects respirator hood to air supply hose. Available with a choice of quick-disconnect fittings, constant or adjustable airflow control and optional climate control devices.

Breathing Tube Assemblies				
Without Climate Control Devices		With Climate Control Devices*		
		Cold Only		Hot/Cold
Constant	Adjustable			
V30	V40	AC100030	DC5040	HC240030
V30B	V40B	AC100030B	DC5041	HC240030B
V30S	V40S	AC100030S	DC5042	HC240030S
V31	V41	AC100031	DC5047	HC240031
V32	V42	AC100032		HC240032
V33	V43	AC100033		HC240033
V34	V44	AC100034		HC240034
V35		Frigitron® 2000		
V35B		Frigitron 2000B		
V35S		Frigitron 2000S		

*These climate control devices require the use of the 20BT breathing tube to constitute complete breathing tube assemblies. Breathing tube must be purchased separately.

- 4. AIR SUPPLY HOSE:** Connects breathing tube to air source supplying clean, breathable air.

Hose for High Pressure Compressed Air Source		Hose for Low Pressure Ambient Air Pump
V5 3/8" Coiled I.D. Hose V5 Starter / Extension Hose Available in 25 and 50 foot lengths with a variety of quick-disconnect fitting styles and materials. See parts list for details.	V10 3/8" I.D. Hose V10 Starter Hose / Extension Hose Available in 25, 50 and 100 foot lengths with a variety of quick-disconnect fitting styles and materials. See parts list for details.	V20 1/2" I.D. hose V20 Starter / Extension Hose Available in 50 and 100 foot lengths with a variety of quick-disconnect fitting styles and materials. See parts list for details.

▲ WARNING

1. This respirator, when properly fitted and used, significantly reduces, but does not completely eliminate, the breathing of contaminants by the respirator wearer. You may obtain better respiratory protection from other types of respiratory protection equipment such as a valve-operated pressure-demand airline respirator or a pressure-demand self-contained breathing apparatus respirator.
2. Before using this respirator, be sure your employer has determined that airborne contaminant concentrations do not exceed those allowed by applicable OSHA, MSHA, EPA, NIOSH or ACGIH regulations and recommendations, or any other applicable regulations for continuous-flow airline respirators. Federal law requires that your employer measure and monitor airborne contaminant levels in the work area.
3. Improper respirator use may damage your health and/or cause your death. Improper use may also cause certain life-threatening delayed lung diseases such as silicosis, pneumoconiosis or asbestosis.
4. DO NOT wear this respirator if any of the following conditions exist:
 - Atmosphere is immediately dangerous to your life or health (IDLH).
 - You CANNOT escape without the aid of the respirator.
 - Atmosphere contains less than 19.5% oxygen.
 - Work area is poorly ventilated.
 - Unknown contaminants are present.
 - Contaminants are in excess of regulations or recommendations (as described in item 2 above).
5. Bullard recommends that you not wear this respirator until you have passed a complete physical exam (perhaps including a lung x-ray) conducted by qualified medical personnel and have been trained in the respirator's use, maintenance and limitations by a qualified individual (appointed by your employer) who has extensive knowledge of the Bullard GR50 respirator.
6. DO NOT modify or alter this respirator in any manner. Use only NIOSH- approved Bullard GR50 components and replacement parts manufactured by Bullard for use with this respirator.

Failure to use NIOSH-approved Bullard components and replacement parts such as lenses, hoses, flow control devices and climate control devices, voids NIOSH approval of the entire respirator, invalidates all Bullard warranties and may cause death, lung disease or exposure to other hazardous or life-threatening conditions.
7. Inspect all components of this respirator system daily for signs of wear, tear or damage that might reduce the degree of protection originally provided.

Immediately replace worn or damaged components with NIOSH- approved Bullard GR50 components or remove respirator from service. (See INSPECTION, CLEANING AND STORAGE section on pages 16 and 17 for proper maintenance of the GR50 Series respirator.)

▲ WARNING

8. Be certain your employer has determined that the breathing air source provides at least Grade D breathable air. This respirator must be supplied with clean breathable air at all times.
9. Do not connect the respirator's air supply hose to nitrogen, oxygen, toxic gases, inert gases or other unbreathable, non-Grade D air sources. Check the air source before using the respirator. Failure to connect to the proper air source may result in serious injury or your death.
10. Do not use this respirator in poorly ventilated areas, areas where oxygen content is less than 19.5%, or confined spaces such as tanks, small rooms, tunnels or vessels. Do not use this respirator in poorly ventilated areas, areas where oxygen content is less than 19.5%, or confined spaces such as tanks, small rooms, tunnels or vessels unless the confined space is well-ventilated and contaminant concentrations are below the upper limit recommended for this respirator. In addition, follow all procedures for confined space entry, operation and exit as defined in applicable regulations and standards, including 29 CFR 1910.146.
11. If you have any questions concerning the use of this respirator, or if you are not sure whether the atmosphere you are working in is immediately dangerous to your life or health (IDLH), ask your employer. All instructions for the use and care of this product must be supplied to you by your employer as recommended by the manufacturer and as required by Federal Law (29 CFR 1910.134).
12. Do not use this respirator for abrasive blasting or underwater diving.

For technical assistance, call or write:

E.D. Bullard
1898 Safety Way
Cynthiana, KY 41031-9303
Toll-Free: 800-877-BULLARD
Phone: 859-234-6616
Facsimile: 1-800-877-6858

Protection

Respiratory

This respirator is NIOSH approved (TC-19C-329) for Type C operations. It can be worn for general purpose applications, including grinding.

This respirator is not approved for use in any atmosphere immediately dangerous to life or health (IDLH), or from which the wearer cannot escape without the aid of the respirator.

Head

The GR50 Series respirator hood with the 20TG or 20RT headband DOES NOT provide head protection. If head protection is required, order a Bullard hard hat model C30 or S51.

Respirator hoods used in conjunction with Bullard C30 or S51 hard hats meet ANSI Standard Z89.1-2003, Type I, Class E & G requirements for protective headwear for industrial workers. These hard hats are designed to provide limited head protection by reducing the force of falling objects striking the top of the hard hat shell.

Face

The GR50 Series respirator hood meets ANSI Z87.1-2003 impact and penetration requirements for face protection. The .040 polycarbonate lens provides limited face protection from flying particles or spray of hazardous liquids, but is not shatterproof.

Eyes

GR50 Series respirators DO NOT provide eye protection. Wear approved safety glasses or goggles at all times.

Ears

GR50 Series respirators DO NOT provide hearing protection. Use properly fitted earmuffs, earplugs or other protection when exposed to high noise levels.

Breathing Air Requirements

Air Quality

▲ WARNING

This respirator must be supplied with clean, breath-able air, Grade D or better, at all times. This respirator does NOT purify or filter out contaminants.

Respirable, breathable air must be supplied to the point-of-attachment of the approved Bullard air supply hose. The point-of-attachment is the point at which the air supply hose connects to the air source. A pressure gauge attached to the air source is used to monitor the pressure of air provided to the respirator wearer (see Figure 2).

Supplied breathing air must AT LEAST meet the requirements for Type 1 gaseous air described in the Compressed Gas Association Commodity Specifications G-7.1 (Grade D or higher quality), as specified by Federal Law 42 CFR, Part 84, Subpart J, 84.141 (b).

The requirements for Grade D breathable air include:

–Oxygen	19.5-23.5%
–Hydrocarbons (condensed) in mg/m ³ of gas	5 mg/m ³ max.
–Carbon monoxide	10 ppm max.
–Carbon dioxide	1,000 ppm max.
–Odor	*
–No toxic contaminants at levels that make air unsafe to breathe.	

* Specific measurement of odor in gaseous air is impractical. Air normally may have a slight odor. The presence of a pronounced odor should render the air unsatisfactory.

Contact the Compressed Gas Association (1235 Jefferson Davis Highway, Arlington, VA 22202) for complete details on Commodity Specifications G7.1.

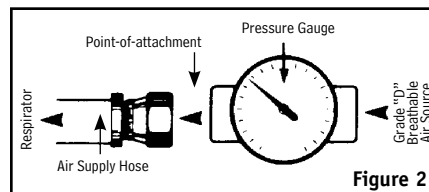

Air Source

Locate the source of supplied air, whether it is a breathing air compressor or an ambient air pump, in a clean air environment. Locate the air source far enough from your work site to ensure the air remains contaminant-free. Always use an inlet filter on your air source.

Use suitable after-cooler/dryers with filters, carbon monoxide monitors and alarms as necessary to assure clean, breathable air at all times.

The air should be regularly sampled to be sure that it meets Grade D requirements.

Breathing Air Pressure

Air pressure must be continually monitored at the point-of-attachment while operating this respirator. A reliable air pressure gauge must be present to permit you to continually monitor the pressure during actual respirator operation.

▲ WARNING

FAILURE TO SUPPLY THE MINIMUM REQUIRED PRESSURE AT THE POINT-OF-ATTACHMENT FOR YOUR HOSE LENGTH AND TYPE WILL REDUCE AIRFLOW AND MAY EXPOSE YOU TO LIFE-THREATENING CONDITIONS, DISEASES OR DEATH.

The Breathing Air Pressure Table (see page 9) defines the air pressure ranges necessary to provide GR50 Series respirators with a volume of air that falls within the required range of 6-15 cfm or 170-425 lpm (Ref. 42 CFR, Part 84, Subpart J, 84.150).

Make sure you understand the information in the Breathing Air Pressure Table before using this respirator.

1. Determine the type of air source you are using (Column 1), then find your breathing tube assembly (Column 2).

2. Be sure your Bullard air supply hose(s) (Column 3) is approved for use with your breathing tube assembly.
3. Determine that your air supply hose is within the approved length (Column 4).
4. Make sure you have not exceeded the maximum number of hose sections (Column 5).
5. Set the air pressure at the point-of-attachment within the required pressure range (Column 6) for your breathing tube assembly, and air supply hose type and length.

Breathing Air Supply Hoses and Hose Fittings

NIOSH-approved Bullard air supply hose(s) MUST be used between the breathing tube connection fitting on the wearer's belt and the point-of-attachment to the air supply.

NIOSH-approved Bullard quick-disconnect fittings MUST be used to connect V5 or V20 hose lengths together. When connecting lengths of V10 hose, only use Bullard V11 hose-to-hose adaptors. Secure connection(s) until wrench-tight and leak-free. Total connected hose length and number of hoses MUST be within the ranges specified on the Breathing Air Pressure Table (see page 9) and the respirator's NIOSH approval label (see page 1).

The breathing tube connection fitting MUST be secured to the belt that is supplied with this respirator. Securing the air entry connection fitting helps prevent the air supply hose from snagging, disconnecting or pulling the respirator hood off your head.

S - Special or Critical User Instructions Breathing Air Pressure Table

This table defines the air pressure ranges necessary to provide GR50 Series respirators with a volume of air that falls within the required range of 6-15 cfm or 170-425 lpm according to U.S. Government regulations (42 CFR, Part 84, Subpart J, 84.150, Table 8).

1	2	3	4	5	6		
Air Source	Breathing Tube Assembly	Air Supply Hose	Air Supply Hose Length (feet)	Maximum Number of Hose Sections	Required Pressure Range (psig air)		
Stationary/ Portable Air Compressor or Breathing Air Cylinder	V30, V30B, V30S, V31, V32, V33, V34, 37	V10	25	1	14-15		
			50	2	15-18		
			100	3	19-24		
			150	4	23-29		
			200	5	25-34		
			250-300	5	31-39		
	V40, V40B, V40S, V41, V42, V43, V44, V47	V10	25	1	22-25		
			50	2	24-27		
			100	3	27-32		
			150	4	30-37		
			200	5	33-40		
			250-300	5	38-45		
AC100030, AC100030B, AC100030S, AC100031, AC100032, AC100033, AC100034, AC100037	V10	25-50	2	55-65			
		75-150	3	60-70			
		175-300	3	65-75			
			3				
			3				
			5				
DCC5040, DC041, DC5042, DC5047	V10	50	2	48-52			
		100	3	59-63			
		150	3	68-72			
		200	3	80-84			
		250	3	85-92			
		300	5	90-98			
HC240030, HC240030B, HC240030S, HC240031, HC240032, HC240033, HC240034, HC240037	V10	25	1	59-61			
		50	2	63-65			
		100	3	68-70			
		150	4	73-75			
		200	4	77-79			
		250	5	80-82			
300	5	84-86					
Bullard Free-Air® Pump	V35, V35B, V35S	V20	50	1	4-6		
			100	2	6-8		
			200	2	10-15		
			300	3	13-18		
			Frigitron® 2000, Frigitron 2000B, Frigitron 2000S	V20	50	1	16-22
					100	2	18-25
200	2	22-30					
300	3	25-34					

Adjusting and Installing Headband in Respirator Hood (If using respirator with Bullard hard hat, see page 12)

To change the headband size, unlock the four pins from the sizing holes. Place the headband on your head. Pull down, allowing headband to expand until it feels comfortable. The headband will automatically adjust to your size. Lock into place by pushing the four pins into the sizing holes (Figure 4).

NOTE

If using the optional 20RT ratchet headband suspension, refer to the instruction sheet provided with the 20RT.

Adjust Crown Straps for Vertical Fit

To improve suspension comfort, adjust crown straps vertically by repositioning the crown strap posts in the crown straps. Vertical adjustment makes the headband ride higher or lower on the wearer's head. To adjust, push crown strap post from slot, move to new slot, and snap in to secure. Move key to desired vertical position. Repeat for other crown strap post (Figure 7).

NOTE

If the hood rises off your head during use, first verify proper air pressure, then select a different hood for your application, or use the optional chin strap.

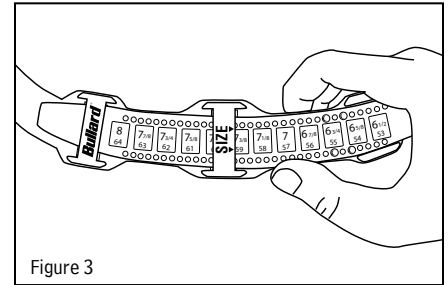

Figure 3



Figure 4

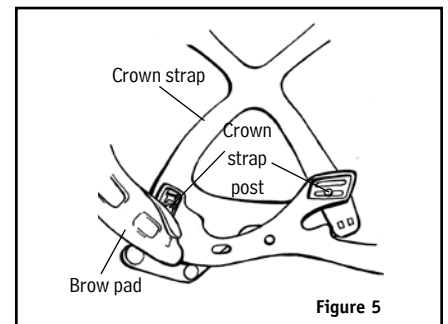

Figure 5

If Using Optional 20NC Chin Strap:

For most wearers, the headband holds the GR50 hood in place without a chin strap. If an optional chin strap is desired, refer to the list of replacement parts and accessories.

1. Remove headband from hood.
2. Snap chin strap stud buttons into the holes on each side of the headband, inserting from the inside.
3. Align holes on chin strap to stud buttons and pull downward to lock in place (see Figure 7).
4. Place headband on your head. Adjust chin strap length with the plastic slide.
5. Remove headband from your head and reinstall in respirator hood.

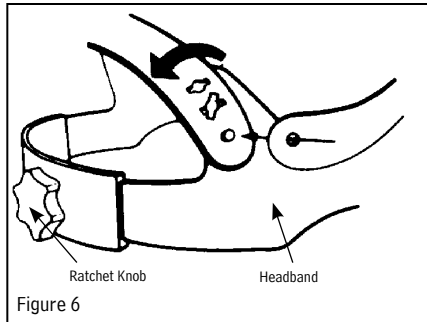

Figure 6

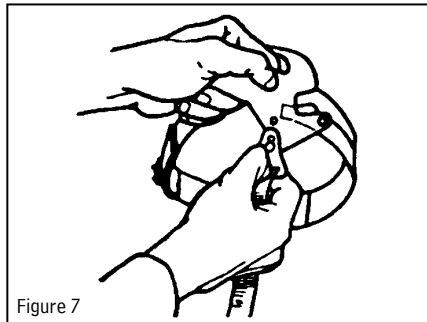

Figure 7

If Using MB1 or GRH0L1 Optional Outer Lens:

1. Remove protective plastic film from the lens that is sewn into the GR50 respirator.
2. Remove protective plastic film from both sides of the protective outer lens.
3. Engage the 4 male snaps of the outer lens to the corresponding 4 female snaps of the inner lens (see Figure 8).
4. When outer lens becomes scratched, replace with another lens. Refer to replacement parts and accessories.



Figure 8

If Using Optional 20LC or 7714 Lens Covers:

1. If desired, apply optional adhesive-backed lens covers designed to protect the respirator's plastic lens. Apply 2-3 lenses at a time.
2. When lens becomes soiled, remove by pulling tab at edge of lens cover to clear your vision.

Adjusting and Installing Hard Hat in Respirator Hood

1. Assemble and adjust the standard Bullard hard hat suspension or optional ratchet suspension by following directions on instruction sheet attached to headband on hard hat. Read all hard hat warning labels and instructions. The following Bullard hard hat models are NIOSH approved for use with GR50 Series respirator hoods: C30, C30R, S51 and S51R.
2. If desired, install and adjust optional ES42 hard hat chin strap.
3. Before inserting hard hat into hood, remove the adhesive-backed Velcro® strip attached to the Velcro piece that is sewn into the hood.
4. Peel the backing off the Velcro tab and apply it to the inside center rear of the hard hat, about 1/4" up from the edge.
5. Insert hard hat into respirator hood with cap visor facing front of hood (see Figure 9).



Figure 9

6. Tuck cap visor above front elastic band sewn into hood (see Figure 10).
7. Loop the Velcro strip sewn inside the hood around the back of the cap and affix it to the corresponding Velcro tab previously installed inside the hard hat in step 3. (see Figure 11).
8. Remove protective film from plastic lens of respirator hood. If desired, apply optional 20LC or 7714 adhesive-backed lens covers designed to protect the respirator's plastic lens. Apply 2-3 lenses at a time. When lens becomes soiled, remove by pulling tab at edge of lens cover to clear your vision.



Figure 10

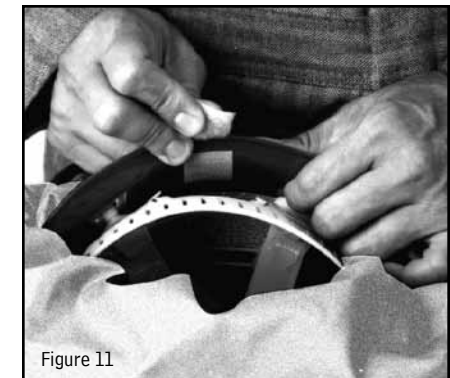

Figure 11

Installing Breathing Tube Assembly

1. Remove nylon clamp from open end of breathing tube (see Figure 12). Do not remove foam from inside the breathing tube. The foam helps reduce the noise level of incoming air.
2. Insert breathing tube approximately five inches into hood's air entry sleeve (see Figure 13).
3. Install nylon clamp over air entry sleeve and breathing tube, inserting clamp locks through two holes in plastic anchorplate that is sewn into hood (see Figure 14). Locks should face away from user's neck.
4. Engage clamp locks and squeeze together until tight.



Figure 13

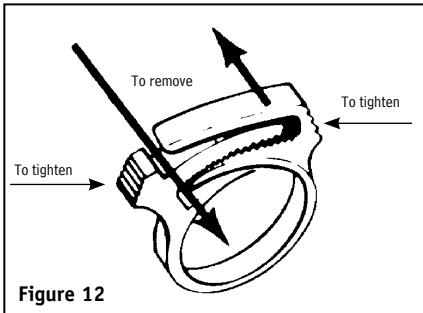

Figure 12



Figure 14

Using Climate Control Devices

GR50 Series respirators are approved by NIOSH for use with four optional Bullard climate control devices: AC1000 Series, DC50 Series, HC2400 Series and Frigatron® 2000 Series.

1. Follow the instructions supplied with your climate control device.
2. Be sure to use only the Bullard breathing tube approved for your climate control device (see page 18).
3. Screw nylon hose connector on end of breathing tube to hose thread on air conditioner.

4. Firmly tighten hose connector by hand (see Figure 15).
5. Lace belt supplied with respirator through belt loop bracket on air conditioner.

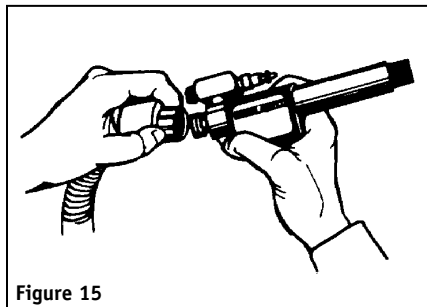

Figure 15

▲ WARNING

Do not put on or remove this respirator in a hazardous atmosphere. Do not remove this respirator in a hazardous atmosphere except for emergency escape purposes.

Donning

Before using your GR50 Series respirator, complete the assembly instructions provided on pages 10-13.

1. Connect NIOSH-approved Bullard air supply hose to air source supplying Grade D breathable air. Turn on breathing air source.
2. With air flowing, connect breathing tube assembly to air supply hose (see Figure 16). Connect quick-disconnect fitting on breathing tube assembly to quick-disconnect coupler on air supply hose. Once fitting is secured, release coupling sleeve to lock fittings together. Pull on both hoses to make sure they are attached securely.
3. Adjust air pressure at point-of-attachment to within the approved pressure range (see Figure 17). See the Breathing Air Pressure Table (page 9) for approved pressure ranges.
4. With air still flowing, put on GR50 Series respirator hood, inserting chin first.
5. Position headband or hard hat for a comfortable fit. See instructions on page 10 for proper sizing.
6. If using an optional chin strap, pull elastic strap under your chin and adjust for a secure and comfortable fit.
7. Tuck inner bib of hood into shirt or protective clothing for additional splash and overspray protection (see Figure 18).
8. Pull respirator outer bib over collar of shirt or protective clothing.

9. With breathing tube assembly attached to the hood, fasten belt at waist or hip level and adjust for comfort.
10. Recheck air pressure and adjust if necessary.
11. With air still flowing into your respirator, you are now ready to enter work area.



Figure 16

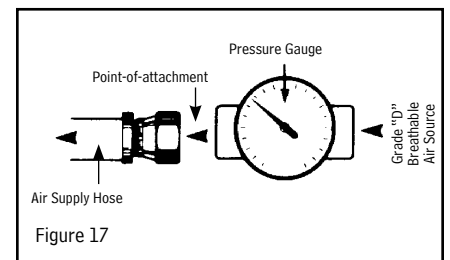

Figure 17



Figure 18

Doffing

When finished working, leave work area wearing respirator and with air still flowing. Once outside contaminated area, remove respirator and then disconnect the air supply hose using the quick-disconnect fittings.

NOTE

If using V20 Series (1/2" I.D.) air supply hose, the hose quick-disconnect coupler does not have a shut-off valve. Therefore, air will continue to flow freely after hose is disconnected from respirator.

▲ WARNING

Leave work area immediately if:

- Any respirator component becomes damaged.
- Airflow into respirator hood stops or slows down.
- Air pressure gauge drops below the minimum specified in Breathing Air Pressure Table (page 9).
- Breathing becomes difficult.
- You become dizzy, nauseous, too hot, too cold or ill.
- You taste, smell or see contaminants inside respirator hood.
- Your vision becomes impaired.

▲ WARNING

DO NOT LEAVE RESPIRATOR IN WORK AREA OR LEAVE IT UNATTENDED IN A CONTAMINATED ENVIRONMENT. RESPIRABLE CONTAMINANTS CAN REMAIN SUSPENDED IN AIR FOR MORE THAN ONE HOUR AFTER WORK ACTIVITY CEASES, EVEN THOUGH YOU MAY NOT SEE THEM. PROPER WORK PRACTICE REQUIRES YOU TO WEAR THE RESPIRATOR UNTIL YOU ARE OUTSIDE THE CONTAMINATED AREA. IF YOU SET THE RESPIRATOR DOWN IN A CONTAMINATED ENVIRONMENT, CONTAMINANTS, DIRT AND DUST COULD GET INTO THE RESPIRATOR. WHEN YOU PUT THE RESPIRATOR BACK ON, YOU COULD BREATHE IN CONTAMINANTS UPON REUSE.

Inspection, Cleaning and Storage

Bullard GR50 Series respirators have a limited service life. Therefore, a regular inspection and replacement program must be conducted.

The Bullard GR50 Series respirator and all component parts and assemblies should be inspected for damage or excessive wear before and after each use to ensure proper functioning. Immediately remove the respirator from service, and replace parts or assemblies that show any sign of failure or excessive wear that might reduce the degree of protection originally provided.

Use only complete NIOSH-approved Bullard GR50 Series components and replacement parts on this respirator. Refer to parts list for correct part numbers.

Since respirator use and the quality of maintenance performed vary with each job site, it is impossible to provide a specific time frame for respirator replacement.

This respirator should be cleaned and sanitized at least weekly, or more often if subjected to heavy use. Respirators used by more than one person must be cleaned, inspected and sanitized after each use. If not cleaned, contamination may cause illness or disease.

REMEMBER, THE AIR YOU BREATHE WILL NOT BE CLEAN UNLESS THE RESPIRATOR YOU WEAR IS CLEAN.

Hood and Headband

INSPECTION: Inspect the hood material for rips, tears or damage from excessive wear that might reduce the degree of protection originally provided. The respirator's plastic lens should be inspected for cracks, scratches or any other signs of damage.

Disassemble the breathing tube from the hood by removing the nylon hose clamp. To remove the hose clamp, slide the locks sideways in opposite directions.

Remove the headband suspension and optional chin strap from the hood. Inspect headband for cracks, frayed or cut crown straps, torn headband or size adjustment slots, loss of pliability or other signs of excessive wear. Check the chin strap for loss of elasticity, cuts and cracked hanger clips.

If damage is detected, replace immediately with Bullard replacement part(s) or remove the respirator from service.

CLEANING: To clean the GR50 respirator hood, remove suspension and optional chin strap. With MB1 or GRHOLI lens attached, hand-wash the GR50 hood in warm water using a mild liquid detergent. Rinse hood with cold water and allow to air-dry. After cleaning and before reassembling, inspect the hood for signs of excessive wear, following the inspection instructions on this page. If damage is detected, remove the respirator from service.

The inner lens, headband suspension and optional chin strap should be hand-sponged with warm water and mild detergent, then rinsed and air-dried. Before reassembling, carefully inspect parts for signs of damage.

Do not use volatile solvents for cleaning this respirator or any parts and assemblies. Strong cleaning and disinfecting agents and many solvents can damage the plastic parts.

Hard Hat

Inspection: Inspect the hard hat shell for nicks, gouges, cracks and any damage due to impact, rough treatment or wear.

Remove the headband suspension and optional chin strap from the hard hat. Inspect the headband for cracks, frayed or cut crown straps, torn headband and size adjustment slots, loss of pliability or other signs of excessive wear. Check the chin strap for loss of elasticity, cuts and cracked hanger clips.

If damage is detected, replace part(s) immediately with Bullard replacement parts or remove the respirator from service.

Cleaning: The hard hat shell, headband suspension and optional chin strap should be hand-sponged with warm water and mild detergent, rinsed and air-dried. After cleaning, and before reassembling, once again carefully inspect parts for signs of damage.

Breathing Tube Assembly

Inspection: Inspect the vinyl breathing tube for tears, cracks, holes or excessive wear that might reduce the degree of protection originally provided. Be sure the quick-disconnect fitting is screwed tightly into the breathing tube so no air can escape.

Be sure the airflow control device is screwed tightly into the breathing tube so air cannot escape.

If any signs of excessive wear are present, replace the breathing tube assembly immediately or remove the respirator from service.

Cleaning: To clean the breathing tube assembly, hand-sponge with warm water and mild detergent, rinse and air-dry. Do not get water inside the flow control device or breathing tube. After cleaning, once again carefully inspect breathing tube for signs of damage.

▲ WARNING

Do not cut or remove foam that is inside the breathing tube. The foam helps reduce the noise level of the incoming air supply. It does not filter or purify your breathing air. NIOSH has approved this respirator with the foam in place.

Air Supply Hoses

Inspection: The starter and extension hose(s) should be inspected closely for abrasions, corrosion, cuts, cracks and blistering. Be sure the hose fittings are crimped tightly to the hose so that no air can escape. Make sure the hose has not been kinked or crushed by any equipment that may have rolled over it.

If any of the above signs are present or any other signs of excessive wear are detected, replace the hose(s) immediately or remove the respirator from service.

Cleaning: The air supply hose(s) should be hand-sponged with warm water and mild detergent, rinsed and air-dried. Do not get water inside the air supply hose. After cleaning, once again carefully inspect air supply hose(s) for signs of damage.

▲ WARNING

Only use Bullard hoses that are NIOSH-approved for use with this respirator. Other hoses could reduce airflow and protection, and expose the wearer to life-threatening conditions.

Storage

After reusable respirator components have been cleaned and inspected, place them in a plastic bag or an airtight container.

Store the respirator and parts where they will be protected from contamination, distortion and damage from elements such as dust, direct sunlight, heat, extreme cold, excessive moisture and harmful chemicals.

Parts and Accessories for GR50 Series Airline Respirators

GR50 Series airline respirators consist of four components: respirator hood, headband suspension or head protection, breathing tube assembly and air supply hose. There are options for some components to fit customer specifications. All four components must be present and properly assembled, including a Bullard air supply hose, to constitute a complete NIOSH-approved respirator (Approval No. TC-19C-329, Type C).

Cat. No. Description

RESPIRATOR SYSTEM

GR50SYS Includes GR5035 respirator, EDP10 Free-Air® pump and V20100ST air supply hose.

RESPIRATOR ASSEMBLIES

Includes GRH hood, 20TG suspension, breathing tube assembly with belt and MB1 outer lens.

For use with breathing air compressors or breathing air cylinders:

GR5030 Nomex® grinding hood with V30 constant-flow breathing tube assembly

For use with Bullard Free-Air pumps:

GR5035 Nomex grinding hood with V35 constant-flow breathing tube assembly

1. RESPIRATOR HOOD

Fire-Retardant Nomex hood with FR cotton inner bib.

GRH Replacement hood

Replacement Parts and Optional Accessories

MB1 Outer lens--.020 PETG (10/pkg)
 GRH0L1 Outer lens--.040 Polycarbonate (10/pkg)
 7714 Lens covers (25/pkg)
 20LC Lens covers (25/pkg)
 20TG Headband
 20RT Ratchet headband
 20NC Chin strap for 20TG and 20RT headband

2. HEADBAND SUSPENSIONS AND HARD HATS

C30 Hard hat
 RS6PC Standard suspension for C30 hard hat
 C30R Hard hat with ratchet suspension
 RS6RC Ratchet suspension for C30 hard hat
 S51 Hard hat with TG600
 RS4PC Standard suspension for S51 hard hat
 S51R Hard hat with ratchet suspension
 RS4RC Ratchet suspension for S51 hard hat
 ES42 Chin strap for C30 and S51 hard hat

Cat. No. Description

3. REPLACEMENT AND OPTIONAL BREATHING TUBE ASSEMBLIES AND PARTS

Constant-Flow breathing tube assemblies (includes belt)

V30 1/4" Industrial Interchange, steel quick-disconnect fitting
 V31 1/4" Schrader, steel quick-disconnect fitting
 V32 1/4" Snap-Tite, steel quick-disconnect fitting
 V33 1/4" Snap-Tite, brass quick-disconnect fitting
 V35 1/2" Industrial Interchange, steel quick-disconnect fitting (for use with Bullard Free-Air® pumps)

Air Conditioners

(does not include breathing tube)

AC1000* 1/4" Industrial Interchange, steel quick-disconnect fitting
 AC100031* 1/4" Schrader, steel quick-disconnect fitting
 AC100032* 1/4" Snap-Tite, steel quick-disconnect fitting

Hot/Cold Tubes - Adjustable Flow (does not include breathing tube)

HC2400* 1/4" Industrial Interchange, steel quick-disconnect fitting
 HC240031* 1/4" Schrader, steel quick-disconnect fitting
 HC240032* 1/4" Snap-Tite, steel quick-disconnect fitting

DUAL-COOL™ Tube - Adjustable Flow (does not include breathing tube)

DC5040* DUAL-COOL tube with 1/4" Industrial Interchange (steel) quick-disconnect fitting. Order DUAL-COOL vest separately.

NOTE

All climate control devices require use of the 20BT breathing tube to constitute complete breathing tube assemblies. Breathing tube must be purchased separately.

DUAL-COOL™ VEST (does not include breathing tube or belt)

DC70ML	DUAL-COOL vest. Size: M/L. Order DUAL-COOL tube separately.
DC70LXXL	DUAL-COOL vest. Size: XL/XXL. Order DUAL-COOL tube separately.
DC705X	DUAL-COOL vest. Size: 5XL. Order DUAL-COOL tube separately.

Frigitron® 2000 for use with Bullard EDP30 Free-Air® Pumps (does not include breathing tube or belt)

Frigitron 2000*	1/2" Industrial Interchange, steel quick-disconnect fitting
-----------------	--

Replacement Parts for Breathing Tube Assembly

20BT	Breathing tube
4612	Belt, nylon webbing
272555	Belt, nylon webbing (Frigitron)
S18051	Nylon clamp for use with all breathing tubes

4. AIR SUPPLY HOSE

V10 Series Hoses (3/8" I.D.)

STARTER HOSES Each hose includes V13 adaptor fitting (3/8" hose to 3/8" pipe)

4696	25' Starter hose with 1/4" Industrial Interchange Q.D. coupler
46913	25' Starter hose with 1/4" Schrader Q.D. coupler
46915	25' Starter hose with 1/4" Snap-Tite Q.D. coupler

EXTENSION HOSES Each hose includes V11 hose-to-hose adaptor fitting and V13 hose-to-pipe fitting (3/8" hose to 3/8" pipe)

5454	25' Extension hose
5457	50' Extension hose
5458	100' Extension hose

V20 Series Hoses for use with Free-Air Pumps (1/2" I.D.)

V2050ST	50' Starter/Extension hose with 1/2" Industrial Interchange Q.D. coupler
V20100ST	100' Starter/Extension hose with 1/2" Industrial Interchange Q.D. coupler

V5 Series Coiled Hoses

V52530	25' Starter hose with 1/4" Industrial Interchange Q.D. coupler
--------	--

Cat. No. Description

V55030	50' Starter hose with 1/4" Industrial Interchange Q.D. coupler
V52531	25' Starter hose with 1/4" Schrader Q.D. coupler
V55031	50' Starter hose with 1/4" Schrader Q.D. coupler
V52532	25' Starter hose with 1/4" Snap-Tite Q.D. coupler
V55032	50' Starter hose with 1/4" Snap-Tite Q.D. coupler
V52533	25' Starter hose with 1/4" Snap-Tite, brass Q.D. coupler
V55033	50' Starter hose with 1/4" Snap-Tite brass Q.D. coupler

Quick-Disconnect Nipples, Couplers and Adaptors

NIPPLES

1/4" Industrial Interchange

S9841	With 1/4" Female NPT
V17	With 3/8" Female NPT

1/4" Schrader

S19432	With 1/4" Female NPT
S19433	With 3/8" Female NPT

1/4" Snap-Tite

S19442	With 1/4" Female NPT
S17651	With 3/8" Female NPT

Couplers (SHUT-OFF TYPE)

1/4" Industrial Interchange

V14	With 1/4" Female NPT
V15	With 3/8" Male NPT

1/4" Schrader

V18	With 1/4" Female NPT
-----	----------------------

1/4" Snap-Tite

V19	With 1/4" Female NPT
-----	----------------------

HOSE ADAPTORS

V11	Hose-to-hose, 3/8" hose to 3/8" hose
V12	Hose-to-pipe, 3/8" hose to 1/4" pipe
V13	Hose-to-pipe, 3/8" hose to 3/8" pipe

*NOTE

All climate control devices require use of the 20BT breathing tube to constitute complete breathing tube assemblies. Breathing tube must be purchased separately.

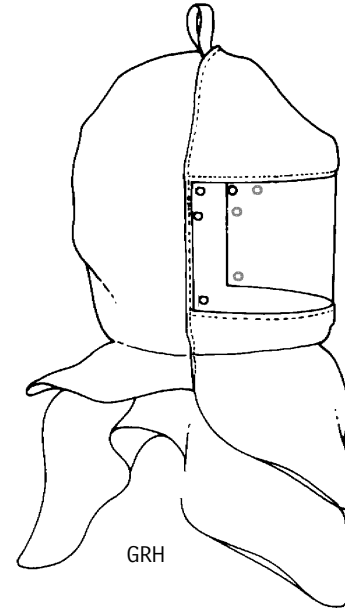

GRH



C30



S51



ESRTSL/RS6RC

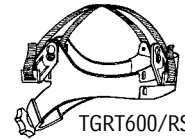

TGRT600/RS4RP



ES-ULTRA/RS6PC

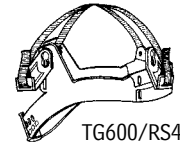

TG600/RS4PP

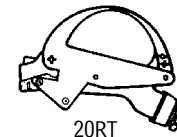

20RT



ES42

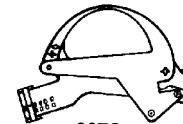

20TG



20NC

V30 Series Breathing Tube Assembly

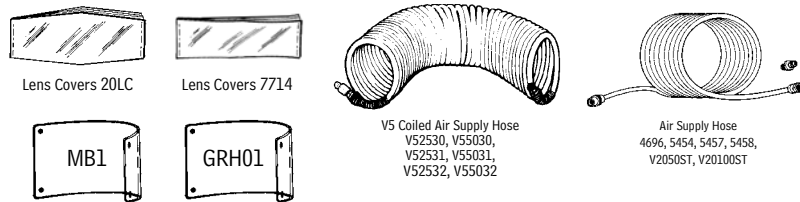
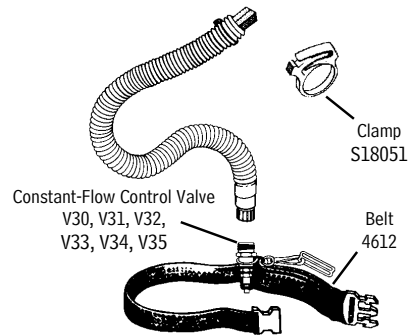

Frigitron® 2000

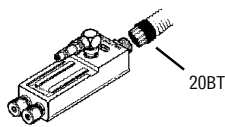

AC1000
AC100031
AC100032

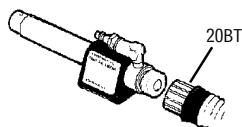

HC2400
HC240031
HC240032

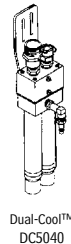
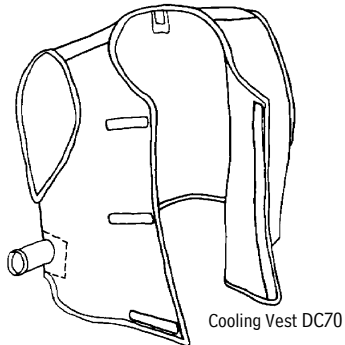
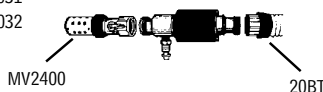

RETURN AUTHORIZATIONS

IMPORTANT: THE FOLLOWING STEPS MUST BE COMPLETED BEFORE E.D. BULLARD COMPANY WILL ACCEPT ANY RETURNED GOODS. PLEASE READ CAREFULLY.

Follow the steps outlined below to return goods to E.D. Bullard Company for repair or replacement under warranty or for paid repairs:

1. Contact your Bullard Customer Service Coordinator by telephone or in writing at:

E.D. Bullard
1898 Safety Way
Cynthiana, KY 41031-9303
Toll-Free: 800-877-BULLARD
Phone: 859-234-6616

In your correspondence or conversation with your Customer Service Coordinator, describe the problem as completely as possible. For your convenience, your coordinator will try to help you correct the problem over the phone.

2. Verify with your coordinator that the product should be returned to Bullard. Customer Service will provide you with written permission and a return authorization number as well as the labels you will need to return the product.
3. Before returning the product, decontaminate and clean it to remove any hazardous materials which may have settled on the product during use. Laws and/or regulations prohibit the shipment of hazardous or contaminated materials. Products suspected to be contaminated will be professionally discarded at the customer's expense.
4. Ship returned products, including those under warranty, with all transportation charges pre-paid. Bullard cannot accept returned goods on a freight collect basis.
5. Returned products will be inspected upon return to the Bullard facility. Your Customer Service Coordinator will telephone you with a quote for required repair work which is not covered by warranty. If the cost of repairs exceeds stated quote by more than 20%, your coordinator will call you for authorization to complete repairs. After repairs are completed and the goods have been returned to you, Bullard will invoice you for actual work performed.



GR50 Series Airline Respirator User Manual

Distributed By:



2717 Tobey • Indianapolis, IN 46219
(317) 545-0665 • FAX (317) 545-0670 • (800) 800-0665
www.idsblast.com



©2010 Bullard. All rights reserved.

6081850020C (1010)

Americas:

E.D. Bullard Company
1898 Safety Way
Cynthiana, KY 41031-9303
Toll free: 877-BULLARD (285-5273)
Tel: 859-234-6616
Fax: 859-234-8987
www.bullard.com

Europe:

Bullard GmbH
Lilienthalstrasse 12
53424 Remagen • Germany
Tel: +49-2642 999980
Fax : +49-2642 9999829
www.bullardextrem.com

Asia-Pacific:

Bullard Asia Pacific Pte. Ltd.
LHK Building
701, Sims Drive, #04-03
Singapore 387383
Tel: +65-6745-0556
Fax: +65-6745-5176
www.bullard.com