

General Information

Bullard's GR50 Series airline respirators, when properly used, provide a continuous flow of air from a remote air source, through a patented air delivery system (U.S. Patent 4,484,575), to the respirator wearer. GR50 Series respirators offer protection from airborne contaminants that are not immediately dangerous to life or health (IDLH), or that do not exceed concentrations allowed by applicable OSHA, MSHA, EPA, NIOSH or ACGIH regulations and recommendations, or any other applicable regulations.

GR50 Series airline respirators are approved by NIOSH (TC-19C-329, Type C) to provide respiratory protection in grinding operations and other such general purpose applications. The GR50 is NOT intended for use in any abrasive blasting operation.

GR50 Series respirators are compatible with breathing air sources such as breathing air compressors or Bullard Free-Air® pumps. Bullard offers the appropriate approved breathing tube assembly and air supply hose to connect the GR50 Series respirator to these breathing air sources.

GR50 Series respirators are approved by NIOSH for use with optional Bullard climate control devices.

The GRH Hood of the GR50 Series can also be configured for use with the Bullard EVA PAPR. Refer to the EVA Manual for details.



Type C Continuous-Flow Class

NIOSH Approval No. TC-19C-329

Not approved for abrasive blasting.

Read all instructions and warnings before using this respirator. Save this manual for future reference.

Table of Contents

Approval Label	1,2	GR50 Respirator Use	15,16
General Information	3	Inspection, Cleaning and Storage	17,18
Component Concept.....	4, 5	Parts and Accessories for GR50 Series Airline Respirators	19-22
Warnings.....	6, 7	Return Authorizations	23
Operations.....	8-10		
GR50 Respirator Assembly	11-14		

Component Concept

Bullard GR50 Series airline respirators consist of four components (Figure 1). All must be present and properly assembled to constitute a complete NIOSH-approved respirator.

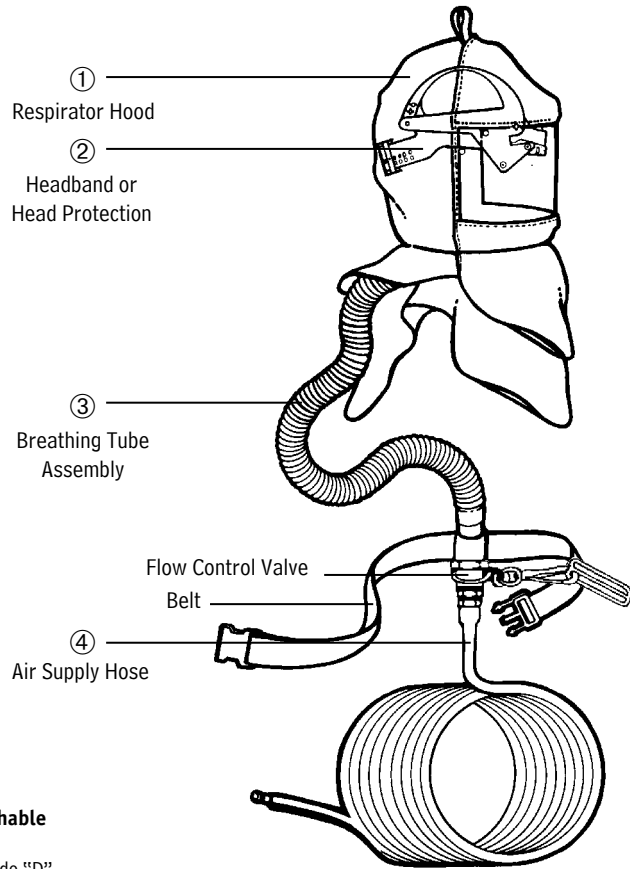

Figure 1

**Clean Breathable
Air Source**
Supplying Grade "D"
or Higher Air Quality (See Breathing
Air Requirements on page 7)

▲ WARNING

Failure to use complete NIOSH-approved Bullard components and replacement parts voids approval of entire assembly. Basic parts are listed on the NIOSH Approval Label on page 1.

Component Concept (continued)

- 1. Respirator Hood**
- 2. Headband or head protection**
- 3. Breathing tube assembly:** Connects respirator hood to air supply hose. Available with a choice of quick-disconnect fittings, constant or adjustable airflow control and optional climate control devices.

Breathing Tube Assemblies				
Without Climate Control Devices		With Climate Control Devices*		
		Cold Only		Hot/Cold
Constant	Adjustable			
V30	V40	AC100030	DC5040	HC240030
V30B	V40B	AC100030B	DC5041	HC240030B
V30S	V40S	AC100030S	DC5042	HC240030S
V31	V41	AC100031	DC5047	HC240031
V32	V42	AC100032		HC240032
V33	V43	AC100033		HC240033
V34	V44	AC100034		HC240034
V35		Frigitron® 2000		
V35B		Frigitron 2000B		
V35S		Frigitron 2000S		

*These climate control devices require the use of the 20BT breathing tube to constitute complete breathing tube assemblies. Breathing tube must be purchased separately.

- 4. AIR SUPPLY HOSE:** Connects breathing tube to air source supplying clean, breathable air.

Hose for High Pressure Compressed Air Source		Hose for Low Pressure Ambient Air Pump
V5 3/8" Coiled I.D. Hose V5 Starter / Extension Hose Available in 25 and 50 foot lengths with a variety of quick-disconnect fitting styles and materials. See parts list for details.	V10 3/8" I.D. Hose V10 Starter Hose / Extension Hose Available in 25, 50 and 100 foot lengths with a variety of quick-disconnect fitting styles and materials. See parts list for details.	V20 1/2" I.D. hose V20 Starter / Extension Hose Available in 50 and 100 foot lengths with a variety of quick-disconnect fitting styles and materials. See parts list for details.

▲ WARNING

1. This respirator, when properly fitted and used, significantly reduces, but does not completely eliminate, the breathing of contaminants by the respirator wearer. You may obtain better respiratory protection from other types of respiratory protection equipment such as a valve-operated pressure-demand airline respirator or a pressure-demand self-contained breathing apparatus respirator.
2. Before using this respirator, be sure your employer has determined that airborne contaminant concentrations do not exceed those allowed by applicable OSHA, MSHA, EPA, NIOSH or ACGIH regulations and recommendations, or any other applicable regulations for continuous-flow airline respirators. Federal law requires that your employer measure and monitor airborne contaminant levels in the work area.
3. Improper respirator use may damage your health and/or cause your death. Improper use may also cause certain life-threatening delayed lung diseases such as silicosis, pneumoconiosis or asbestosis.
4. DO NOT wear this respirator if any of the following conditions exist:
 - Atmosphere is immediately dangerous to your life or health (IDLH).
 - You CANNOT escape without the aid of the respirator.
 - Atmosphere contains less than 19.5% oxygen.
 - Work area is poorly ventilated.
 - Unknown contaminants are present.
 - Contaminants are in excess of regulations or recommendations (as described in item 2 above).
5. Bullard recommends that you not wear this respirator until you have passed a complete physical exam (perhaps including a lung x-ray) conducted by qualified medical personnel and have been trained in the respirator's use, maintenance and limitations by a qualified individual (appointed by your employer) who has extensive knowledge of the Bullard GR50 respirator.
6. DO NOT modify or alter this respirator in any manner. Use only NIOSH- approved Bullard GR50 components and replacement parts manufactured by Bullard for use with this respirator.

Failure to use NIOSH-approved Bullard components and replacement parts such as lenses, hoses, flow control devices and climate control devices, voids NIOSH approval of the entire respirator, invalidates all Bullard warranties and may cause death, lung disease or exposure to other hazardous or life-threatening conditions.
7. Inspect all components of this respirator system daily for signs of wear, tear or damage that might reduce the degree of protection originally provided.

Immediately replace worn or damaged components with NIOSH- approved Bullard GR50 components or remove respirator from service. (See INSPECTION, CLEANING AND STORAGE section on pages 16 and 17 for proper maintenance of the GR50 Series respirator.)

▲ WARNING

8. Be certain your employer has determined that the breathing air source provides at least Grade D breathable air. This respirator must be supplied with clean breathable air at all times.
9. Do not connect the respirator's air supply hose to nitrogen, oxygen, toxic gases, inert gases or other unbreathable, non-Grade D air sources. Check the air source before using the respirator. Failure to connect to the proper air source may result in serious injury or your death.
10. Do not use this respirator in poorly ventilated areas, areas where oxygen content is less than 19.5%, or confined spaces such as tanks, small rooms, tunnels or vessels.10. Do not use this respirator in poorly ventilated areas, areas where oxygen content is less than 19.5%, or confined spaces such as tanks, small rooms, tunnels or vessels unless the confined space is well-ventilated and contaminant concentrations are below the upper limit recommended for this respirator. In addition, follow all procedures for confined space entry, operation and exit as defined in applicable regulations and standards, including 29 CFR 1910.146.
11. If you have any questions concerning the use of this respirator, or if you are not sure whether the atmosphere you are working in is immediately dangerous to your life or health (IDLH), ask your employer. All instructions for the use and care of this product must be supplied to you by your employer as recommended by the manufacturer and as required by Federal Law (29 CFR 1910.134).
12. Do not use this respirator for abrasive blasting or underwater diving.

For technical assistance, call or write:

E.D. Bullard
1898 Safety Way
Cynthiana, KY 41031-9303
Toll-Free: 800-877-BULLARD
Phone: 859-234-6616
Facsimile: 1-800-877-6858

Protection

Respiratory

This respirator is NIOSH approved (TC-19C-329) for Type C operations. It can be worn for general purpose applications, including grinding.

This respirator is not approved for use in any atmosphere immediately dangerous to life or health (IDLH), or from which the wearer cannot escape without the aid of the respirator.

Head

The GR50 Series respirator hood with the 20TG or 20RT headband DOES NOT provide head protection. If head protection is required, order a Bullard hard hat model C30 or S51.

Respirator hoods used in conjunction with Bullard C30 or S51 hard hats meet ANSI Standard Z89.1-2003, Type I, Class E & G requirements for protective headwear for industrial workers. These hard hats are designed to provide limited head protection by reducing the force of falling objects striking the top of the hard hat shell.

Face

The GR50 Series respirator hood meets ANSI Z87.1-2003 impact and penetration requirements for face protection. The .040 polycarbonate lens provides limited face protection from flying particles or spray of hazardous liquids, but is not shatterproof.

Eyes

GR50 Series respirators DO NOT provide eye protection. Wear approved safety glasses or goggles at all times.

Ears

GR50 Series respirators DO NOT provide hearing protection. Use properly fitted earmuffs, earplugs or other protection when exposed to high noise levels.

Breathing Air Requirements

Air Quality

▲ WARNING

This respirator must be supplied with clean, breath-able air, Grade D or better, at all times. This respirator does NOT purify or filter out contaminants.

Respirable, breathable air must be supplied to the point-of-attachment of the approved Bullard air supply hose. The point-of-attachment is the point at which the air supply hose connects to the air source. A pressure gauge attached to the air source is used to monitor the pressure of air provided to the respirator wearer (see Figure 2).

Supplied breathing air must AT LEAST meet the requirements for Type 1 gaseous air described in the Compressed Gas Association Commodity Specifications G-7.1 (Grade D or higher quality), as specified by Federal Law 42 CFR, Part 84, Subpart J, 84.141 (b).

The requirements for Grade D breathable air include:

–Oxygen	19.5-23.5%
–Hydrocarbons (condensed) in mg/m ³ of gas	5 mg/m ³ max.
–Carbon monoxide	10 ppm max.
–Carbon dioxide	1,000 ppm max.
–Odor	*
–No toxic contaminants at levels that make air unsafe to breathe.	

* Specific measurement of odor in gaseous air is impractical. Air normally may have a slight odor. The presence of a pronounced odor should render the air unsatisfactory.

Contact the Compressed Gas Association (1235 Jefferson Davis Highway, Arlington, VA 22202) for complete details on Commodity Specifications G7.1.

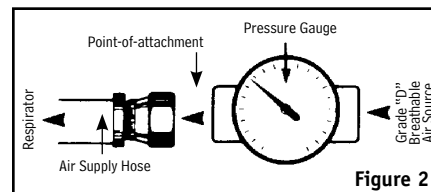

Air Source

Locate the source of supplied air, whether it is a breathing air compressor or an ambient air pump, in a clean air environment. Locate the air source far enough from your work site to ensure the air remains contaminant-free. Always use an inlet filter on your air source.

Use suitable after-cooler/dryers with filters, carbon monoxide monitors and alarms as necessary to assure clean, breathable air at all times.

The air should be regularly sampled to be sure that it meets Grade D requirements.

Breathing Air Pressure

Air pressure must be continually monitored at the point-of-attachment while operating this respirator. A reliable air pressure gauge must be present to permit you to continually monitor the pressure during actual respirator operation.

▲ WARNING

FAILURE TO SUPPLY THE MINIMUM REQUIRED PRESSURE AT THE POINT-OF-ATTACHMENT FOR YOUR HOSE LENGTH AND TYPE WILL REDUCE AIRFLOW AND MAY EXPOSE YOU TO LIFE-THREATENING CONDITIONS, DISEASES OR DEATH.

The Breathing Air Pressure Table (see page 9) defines the air pressure ranges necessary to provide GR50 Series respirators with a volume of air that falls within the required range of 6-15 cfm or 170-425 lpm (Ref. 42 CFR, Part 84, Subpart J, 84.150).

Make sure you understand the information in the Breathing Air Pressure Table before using this respirator.

1. Determine the type of air source you are using (Column 1), then find your breathing tube assembly (Column 2).

2. Be sure your Bullard air supply hose(s) (Column 3) is approved for use with your breathing tube assembly.
3. Determine that your air supply hose is within the approved length (Column 4).
4. Make sure you have not exceeded the maximum number of hose sections (Column 5).
5. Set the air pressure at the point-of-attachment within the required pressure range (Column 6) for your breathing tube assembly, and air supply hose type and length.

Breathing Air Supply Hoses and Hose Fittings

NIOSH-approved Bullard air supply hose(s) MUST be used between the breathing tube connection fitting on the wearer's belt and the point-of-attachment to the air supply.

NIOSH-approved Bullard quick-disconnect fittings MUST be used to connect V5 or V20 hose lengths together. When connecting lengths of V10 hose, only use Bullard V11 hose-to-hose adaptors. Secure connection(s) until wrench-tight and leak-free. Total connected hose length and number of hoses MUST be within the ranges specified on the Breathing Air Pressure Table (see page 9) and the respirator's NIOSH approval label (see page 1).

The breathing tube connection fitting MUST be secured to the belt that is supplied with this respirator. Securing the air entry connection fitting helps prevent the air supply hose from snagging, disconnecting or pulling the respirator hood off your head.

S - Special or Critical User Instructions Breathing Air Pressure Table

This table defines the air pressure ranges necessary to provide GR50 Series respirators with a volume of air that falls within the required range of 6-15 cfm or 170-425 lpm according to U.S. Government regulations (42 CFR, Part 84, Subpart J, 84.150, Table 8).

1	2	3	4	5	6		
Air Source	Breathing Tube Assembly	Air Supply Hose	Air Supply Hose Length (feet)	Maximum Number of Hose Sections	Required Pressure Range (psig air)		
Stationary/ Portable Air Compressor or Breathing Air Cylinder	V30, V30B, V30S, V31, V32, V33, V34, 37	V10	25	1	14-15		
			50	2	15-18		
			100	3	19-24		
			150	4	23-29		
			200	5	25-34		
			250-300	5	31-39		
	V40, V40B, V40S, V41, V42, V43, V44, V47	V10	25	1	22-25		
			50	2	24-27		
			100	3	27-32		
			150	4	30-37		
			200	5	33-40		
			250-300	5	38-45		
AC100030, AC100030B, AC100030S, AC100031, AC100032, AC100033, AC100034, AC100037	V10	25-50	2	55-65			
		75-150	3	60-70			
		175-300	3	65-75			
			3				
			3				
			5				
DCC5040, DC041, DC5042, DC5047	V10	50	2	48-52			
		100	3	59-63			
		150	3	68-72			
		200	3	80-84			
		250	3	85-92			
		300	5	90-98			
HC240030, HC240030B, HC240030S, HC240031, HC240032, HC240033, HC240034, HC240037	V10	25	1	59-61			
		50	2	63-65			
		100	3	68-70			
		150	4	73-75			
		200	4	77-79			
		250	5	80-82			
300	5	84-86					
Bullard Free-Air® Pump	V35, V35B, V35S	V20	50	1	4-6		
			100	2	6-8		
			200	2	10-15		
			300	3	13-18		
			Frigitron® 2000, Frigitron 2000B, Frigitron 2000S	V20	50	1	16-22
					100	2	18-25
200	2	22-30					
300	3	25-34					

Adjusting and Installing Headband in Respirator Hood (If using respirator with Bullard hard hat, see page 12)

To change the headband size, unlock the four pins from the sizing holes. Place the headband on your head. Pull down, allowing headband to expand until it feels comfortable. The headband will automatically adjust to your size. Lock into place by pushing the four pins into the sizing holes (Figure 4).

NOTE

If using the optional 20RT ratchet headband suspension, refer to the instruction sheet provided with the 20RT.

Adjust Crown Straps for Vertical Fit

To improve suspension comfort, adjust crown straps vertically by repositioning the crown strap posts in the crown straps. Vertical adjustment makes the headband ride higher or lower on the wearer's head. To adjust, push crown strap post from slot, move to new slot, and snap in to secure. Move key to desired vertical position. Repeat for other crown strap post (Figure 7).

NOTE

If the hood rises off your head during use, first verify proper air pressure, then select a different hood for your application, or use the optional chin strap.

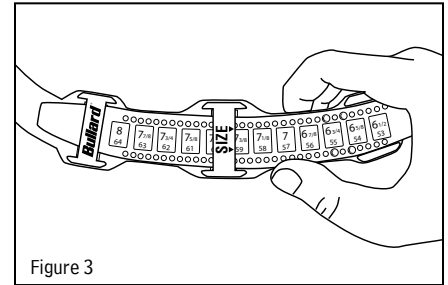

Figure 3



Figure 4

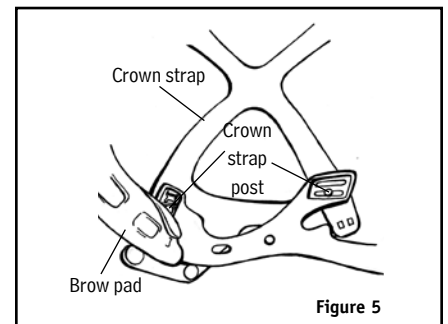

Figure 5

If Using Optional 20NC Chin Strap:

For most wearers, the headband holds the GR50 hood in place without a chin strap. If an optional chin strap is desired, refer to the list of replacement parts and accessories.

1. Remove headband from hood.
2. Snap chin strap stud buttons into the holes on each side of the headband, inserting from the inside.
3. Align holes on chin strap to stud buttons and pull downward to lock in place (see Figure 7).
4. Place headband on your head. Adjust chin strap length with the plastic slide.
5. Remove headband from your head and reinstall in respirator hood.

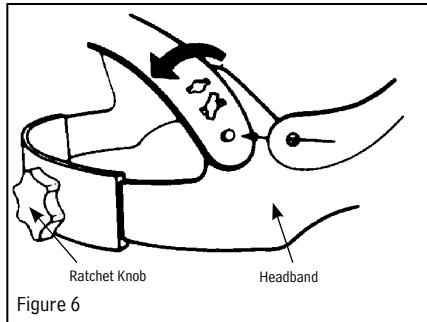

Figure 6

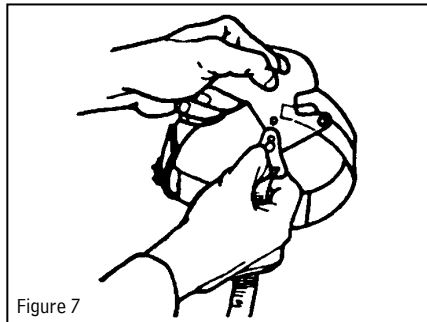

Figure 7

If Using MB1 or GRH0L1 Optional Outer Lens:

1. Remove protective plastic film from the lens that is sewn into the GR50 respirator.
2. Remove protective plastic film from both sides of the protective outer lens.
3. Engage the 4 male snaps of the outer lens to the corresponding 4 female snaps of the inner lens (see Figure 8).
4. When outer lens becomes scratched, replace with another lens. Refer to replacement parts and accessories.



Figure 8

If Using Optional 20LC or 7714 Lens Covers:

1. If desired, apply optional adhesive-backed lens covers designed to protect the respirator's plastic lens. Apply 2-3 lenses at a time.
2. When lens becomes soiled, remove by pulling tab at edge of lens cover to clear your vision.

Adjusting and Installing Hard Hat in Respirator Hood

1. Assemble and adjust the standard Bullard hard hat suspension or optional ratchet suspension by following directions on instruction sheet attached to headband on hard hat. Read all hard hat warning labels and instructions. The following Bullard hard hat models are NIOSH approved for use with GR50 Series respirator hoods: C30, C30R, S51 and S51R.
2. If desired, install and adjust optional ES42 hard hat chin strap.
3. Before inserting hard hat into hood, remove the adhesive-backed Velcro® strip attached to the Velcro piece that is sewn into the hood.
4. Peel the backing off the Velcro tab and apply it to the inside center rear of the hard hat, about 1/4" up from the edge.
5. Insert hard hat into respirator hood with cap visor facing front of hood (see Figure 9).



Figure 9

6. Tuck cap visor above front elastic band sewn into hood (see Figure 10).
7. Loop the Velcro strip sewn inside the hood around the back of the cap and affix it to the corresponding Velcro tab previously installed inside the hard hat in step 3. (see Figure 11).
8. Remove protective film from plastic lens of respirator hood. If desired, apply optional 20LC or 7714 adhesive-backed lens covers designed to protect the respirator's plastic lens. Apply 2-3 lenses at a time. When lens becomes soiled, remove by pulling tab at edge of lens cover to clear your vision.



Figure 10

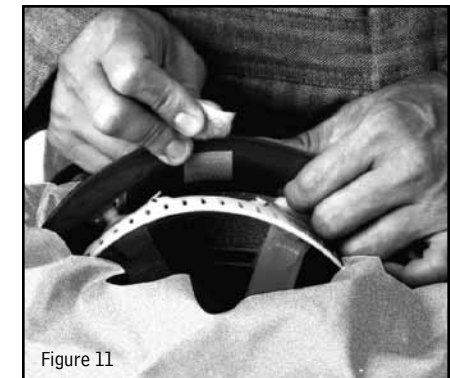

Figure 11

Installing Breathing Tube Assembly

1. Remove nylon clamp from open end of breathing tube (see Figure 12). Do not remove foam from inside the breathing tube. The foam helps reduce the noise level of incoming air.
2. Insert breathing tube approximately five inches into hood's air entry sleeve (see Figure 13).
3. Install nylon clamp over air entry sleeve and breathing tube, inserting clamp locks through two holes in plastic anchorplate that is sewn into hood (see Figure 14). Locks should face away from user's neck.
4. Engage clamp locks and squeeze together until tight.



Figure 13

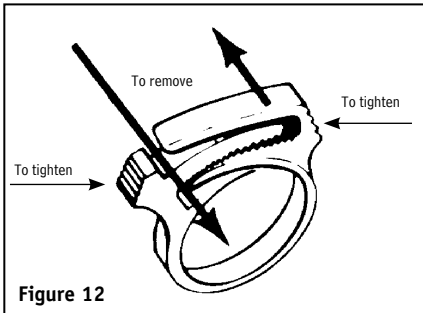

Figure 12



Figure 14

Using Climate Control Devices

GR50 Series respirators are approved by NIOSH for use with four optional Bullard climate control devices: AC1000 Series, DC50 Series, HC2400 Series and Frigatron® 2000 Series.

1. Follow the instructions supplied with your climate control device.
2. Be sure to use only the Bullard breathing tube approved for your climate control device (see page 18).
3. Screw nylon hose connector on end of breathing tube to hose thread on air conditioner.

4. Firmly tighten hose connector by hand (see Figure 15).
5. Lace belt supplied with respirator through belt loop bracket on air conditioner.

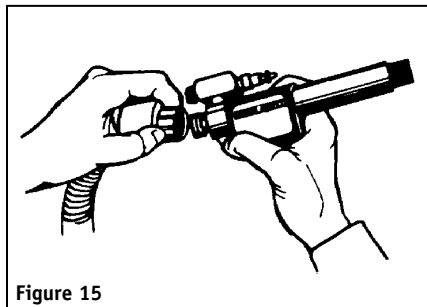

Figure 15

▲ WARNING

Do not put on or remove this respirator in a hazardous atmosphere. Do not remove this respirator in a hazardous atmosphere except for emergency escape purposes.

Donning

Before using your GR50 Series respirator, complete the assembly instructions provided on pages 10-13.

1. Connect NIOSH-approved Bullard air supply hose to air source supplying Grade D breathable air. Turn on breathing air source.
2. With air flowing, connect breathing tube assembly to air supply hose (see Figure 16). Connect quick-disconnect fitting on breathing tube assembly to quick-disconnect coupler on air supply hose. Once fitting is secured, release coupling sleeve to lock fittings together. Pull on both hoses to make sure they are attached securely.
3. Adjust air pressure at point-of-attachment to within the approved pressure range (see Figure 17). See the Breathing Air Pressure Table (page 9) for approved pressure ranges.
4. With air still flowing, put on GR50 Series respirator hood, inserting chin first.
5. Position headband or hard hat for a comfortable fit. See instructions on page 10 for proper sizing.
6. If using an optional chin strap, pull elastic strap under your chin and adjust for a secure and comfortable fit.
7. Tuck inner bib of hood into shirt or protective clothing for additional splash and overspray protection (see Figure 18).
8. Pull respirator outer bib over collar of shirt or protective clothing.

9. With breathing tube assembly attached to the hood, fasten belt at waist or hip level and adjust for comfort.
10. Recheck air pressure and adjust if necessary.
11. With air still flowing into your respirator, you are now ready to enter work area.



Figure 16

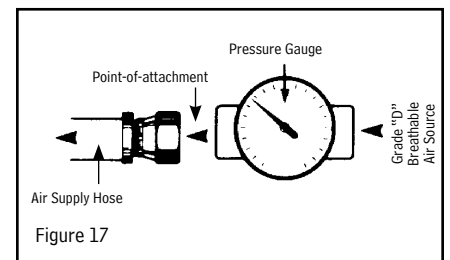

Figure 17



Figure 18

Doffing

When finished working, leave work area wearing respirator and with air still flowing. Once outside contaminated area, remove respirator and then disconnect the air supply hose using the quick-disconnect fittings.

NOTE

If using V20 Series (1/2" I.D.) air supply hose, the hose quick-disconnect coupler does not have a shut-off valve. Therefore, air will continue to flow freely after hose is disconnected from respirator.

WARNING

Leave work area immediately if:

- Any respirator component becomes damaged.
- Airflow into respirator hood stops or slows down.
- Air pressure gauge drops below the minimum specified in Breathing Air Pressure Table (page 9).
- Breathing becomes difficult.
- You become dizzy, nauseous, too hot, too cold or ill.
- You taste, smell or see contaminants inside respirator hood.
- Your vision becomes impaired.

WARNING

DO NOT LEAVE RESPIRATOR IN WORK AREA OR LEAVE IT UNATTENDED IN A CONTAMINATED ENVIRONMENT. RESPIRABLE CONTAMINANTS CAN REMAIN SUSPENDED IN AIR FOR MORE THAN ONE HOUR AFTER WORK ACTIVITY CEASES, EVEN THOUGH YOU MAY NOT SEE THEM. PROPER WORK PRACTICE REQUIRES YOU TO WEAR THE RESPIRATOR UNTIL YOU ARE OUTSIDE THE CONTAMINATED AREA. IF YOU SET THE RESPIRATOR DOWN IN A CONTAMINATED ENVIRONMENT, CONTAMINANTS, DIRT AND DUST COULD GET INTO THE RESPIRATOR. WHEN YOU PUT THE RESPIRATOR BACK ON, YOU COULD BREATHE IN CONTAMINANTS UPON REUSE.

Inspection, Cleaning and Storage

Bullard GR50 Series respirators have a limited service life. Therefore, a regular inspection and replacement program must be conducted.

The Bullard GR50 Series respirator and all component parts and assemblies should be inspected for damage or excessive wear before and after each use to ensure proper functioning. Immediately remove the respirator from service, and replace parts or assemblies that show any sign of failure or excessive wear that might reduce the degree of protection originally provided.

Use only complete NIOSH-approved Bullard GR50 Series components and replacement parts on this respirator. Refer to parts list for correct part numbers.

Since respirator use and the quality of maintenance performed vary with each job site, it is impossible to provide a specific time frame for respirator replacement.

This respirator should be cleaned and sanitized at least weekly, or more often if subjected to heavy use. Respirators used by more than one person must be cleaned, inspected and sanitized after each use. If not cleaned, contamination may cause illness or disease.

REMEMBER, THE AIR YOU BREATHE WILL NOT BE CLEAN UNLESS THE RESPIRATOR YOU WEAR IS CLEAN.

Hood and Headband

INSPECTION: Inspect the hood material for rips, tears or damage from excessive wear that might reduce the degree of protection originally provided. The respirator's plastic lens should be inspected for cracks, scratches or any other signs of damage.

Disassemble the breathing tube from the hood by removing the nylon hose clamp. To remove the hose clamp, slide the locks sideways in opposite directions.

Remove the headband suspension and optional chin strap from the hood. Inspect headband for cracks, frayed or cut crown straps, torn headband or size adjustment slots, loss of pliability or other signs of excessive wear. Check the chin strap for loss of elasticity, cuts and cracked hanger clips.

If damage is detected, replace immediately with Bullard replacement part(s) or remove the respirator from service.

CLEANING: To clean the GR50 respirator hood, remove suspension and optional chin strap. With MB1 or GRHOLI lens attached, hand-wash the GR50 hood in warm water using a mild liquid detergent. Rinse hood with cold water and allow to air-dry. After cleaning and before reassembling, inspect the hood for signs of excessive wear, following the inspection instructions on this page. If damage is detected, remove the respirator from service.

The inner lens, headband suspension and optional chin strap should be hand-sponged with warm water and mild detergent, then rinsed and air-dried. Before reassembling, carefully inspect parts for signs of damage.

Do not use volatile solvents for cleaning this respirator or any parts and assemblies. Strong cleaning and disinfecting agents and many solvents can damage the plastic parts.

Hard Hat

Inspection: Inspect the hard hat shell for nicks, gouges, cracks and any damage due to impact, rough treatment or wear.

Remove the headband suspension and optional chin strap from the hard hat. Inspect the headband for cracks, frayed or cut crown straps, torn headband and size adjustment slots, loss of pliability or other signs of excessive wear. Check the chin strap for loss of elasticity, cuts and cracked hanger clips.

If damage is detected, replace part(s) immediately with Bullard replacement parts or remove the respirator from service.

Cleaning: The hard hat shell, headband suspension and optional chin strap should be hand-sponged with warm water and mild detergent, rinsed and air-dried. After cleaning, and before reassembling, once again carefully inspect parts for signs of damage.

Breathing Tube Assembly

Inspection: Inspect the vinyl breathing tube for tears, cracks, holes or excessive wear that might reduce the degree of protection originally provided. Be sure the quick-disconnect fitting is screwed tightly into the breathing tube so no air can escape.

Be sure the airflow control device is screwed tightly into the breathing tube so air cannot escape.

If any signs of excessive wear are present, replace the breathing tube assembly immediately or remove the respirator from service.

Cleaning: To clean the breathing tube assembly, hand-sponge with warm water and mild detergent, rinse and air-dry. Do not get water inside the flow control device or breathing tube. After cleaning, once again carefully inspect breathing tube for signs of damage.

▲ WARNING

Do not cut or remove foam that is inside the breathing tube. The foam helps reduce the noise level of the incoming air supply. It does not filter or purify your breathing air. NIOSH has approved this respirator with the foam in place.

Air Supply Hoses

Inspection: The starter and extension hose(s) should be inspected closely for abrasions, corrosion, cuts, cracks and blistering. Be sure the hose fittings are crimped tightly to the hose so that no air can escape. Make sure the hose has not been kinked or crushed by any equipment that may have rolled over it.

If any of the above signs are present or any other signs of excessive wear are detected, replace the hose(s) immediately or remove the respirator from service.

Cleaning: The air supply hose(s) should be hand-sponged with warm water and mild detergent, rinsed and air-dried. Do not get water inside the air supply hose. After cleaning, once again carefully inspect air supply hose(s) for signs of damage.

▲ WARNING

Only use Bullard hoses that are NIOSH-approved for use with this respirator. Other hoses could reduce airflow and protection, and expose the wearer to life-threatening conditions.

Storage

After reusable respirator components have been cleaned and inspected, place them in a plastic bag or an airtight container.

Store the respirator and parts where they will be protected from contamination, distortion and damage from elements such as dust, direct sunlight, heat, extreme cold, excessive moisture and harmful chemicals.

Parts and Accessories for GR50 Series Airline Respirators

GR50 Series airline respirators consist of four components: respirator hood, headband suspension or head protection, breathing tube assembly and air supply hose. There are options for some components to fit customer specifications. All four components must be present and properly assembled, including a Bullard air supply hose, to constitute a complete NIOSH-approved respirator (Approval No. TC-19C-329, Type C).

Cat. No. Description

RESPIRATOR SYSTEM

GR50SYS Includes GR5035 respirator, EDP10 Free-Air® pump and V20100ST air supply hose.

RESPIRATOR ASSEMBLIES

Includes GRH hood, 20TG suspension, breathing tube assembly with belt and MB1 outer lens.

For use with breathing air compressors or breathing air cylinders:

GR5030 Nomex® grinding hood with V30 constant-flow breathing tube assembly

For use with Bullard Free-Air pumps:

GR5035 Nomex grinding hood with V35 constant-flow breathing tube assembly

1. RESPIRATOR HOOD

Fire-Retardant Nomex hood with FR cotton inner bib.

GRH Replacement hood

Replacement Parts and Optional Accessories

MB1 Outer lens--.020 PETG (10/pkg)
 GRH0L1 Outer lens--.040 Polycarbonate (10/pkg)
 7714 Lens covers (25/pkg)
 20LC Lens covers (25/pkg)
 20TG Headband
 20RT Ratchet headband
 20NC Chin strap for 20TG and 20RT headband

2. HEADBAND SUSPENSIONS AND HARD HATS

C30 Hard hat
 RS6PC Standard suspension for C30 hard hat
 C30R Hard hat with ratchet suspension
 RS6RC Ratchet suspension for C30 hard hat
 S51 Hard hat with TG600
 RS4PC Standard suspension for S51 hard hat
 S51R Hard hat with ratchet suspension
 RS4RC Ratchet suspension for S51 hard hat
 ES42 Chin strap for C30 and S51 hard hat

Cat. No. Description

3. REPLACEMENT AND OPTIONAL BREATHING TUBE ASSEMBLIES AND PARTS

Constant-Flow breathing tube assemblies (includes belt)

V30 1/4" Industrial Interchange, steel quick-disconnect fitting
 V31 1/4" Schrader, steel quick-disconnect fitting
 V32 1/4" Snap-Tite, steel quick-disconnect fitting
 V33 1/4" Snap-Tite, brass quick-disconnect fitting
 V35 1/2" Industrial Interchange, steel quick-disconnect fitting (for use with Bullard Free-Air® pumps)

Air Conditioners

(does not include breathing tube)

AC1000* 1/4" Industrial Interchange, steel quick-disconnect fitting
 AC100031* 1/4" Schrader, steel quick-disconnect fitting
 AC100032* 1/4" Snap-Tite, steel quick-disconnect fitting

Hot/Cold Tubes - Adjustable Flow (does not include breathing tube)

HC2400* 1/4" Industrial Interchange, steel quick-disconnect fitting
 HC240031* 1/4" Schrader, steel quick-disconnect fitting
 HC240032* 1/4" Snap-Tite, steel quick-disconnect fitting

DUAL-COOL™ Tube - Adjustable Flow (does not include breathing tube)

DC5040* DUAL-COOL tube with 1/4" Industrial Interchange (steel) quick-disconnect fitting. Order DUAL-COOL vest separately.

NOTE

All climate control devices require use of the 20BT breathing tube to constitute complete breathing tube assemblies. Breathing tube must be purchased separately.

DUAL-COOL™ VEST (does not include breathing tube or belt)

- DC70ML DUAL-COOL vest. Size: M/L.
Order DUAL-COOL tube separately.
- DC70LXXL DUAL-COOL vest. Size: XL/XXL.
Order DUAL-COOL tube separately.
- DC705X DUAL-COOL vest. Size: 5XL.
Order DUAL-COOL tube separately.

Frigitron® 2000 for use with Bullard EDP30 Free-Air® Pumps (does not include breathing tube or belt)

- Frigitron 2000* 1/2" Industrial Interchange, steel quick-disconnect fitting

Replacement Parts for Breathing Tube Assembly

- 20BT Breathing tube
- 4612 Belt, nylon webbing
- 272555 Belt, nylon webbing (Frigitron)
- S18051 Nylon clamp for use with all breathing tubes

4. AIR SUPPLY HOSE

V10 Series Hoses (3/8" I.D.)

STARTER HOSES Each hose includes V13 adaptor fitting (3/8" hose to 3/8" pipe)

- 4696 25' Starter hose with 1/4" Industrial Interchange Q.D. coupler
- 46913 25' Starter hose with 1/4" Schrader Q.D. coupler
- 46915 25' Starter hose with 1/4" Snap-Tite Q.D. coupler

EXTENSION HOSES Each hose includes V11 hose-to-hose adaptor fitting and V13 hose-to-pipe fitting (3/8" hose to 3/8" pipe)

- 5454 25' Extension hose
- 5457 50' Extension hose
- 5458 100' Extension hose

V20 Series Hoses for use with Free-Air Pumps (1/2" I.D.)

- V2050ST 50' Starter/Extension hose with 1/2" Industrial Interchange Q.D. coupler
- V20100ST 100' Starter/Extension hose with 1/2" Industrial Interchange Q.D. coupler

V5 Series Coiled Hoses

- V52530 25' Starter hose with 1/4" Industrial Interchange Q.D. coupler

Cat. No. Description

- V55030 50' Starter hose with 1/4" Industrial Interchange Q.D. coupler
- V52531 25' Starter hose with 1/4" Schrader Q.D. coupler
- V55031 50' Starter hose with 1/4" Schrader Q.D. coupler
- V52532 25' Starter hose with 1/4" Snap-Tite Q.D. coupler
- V55032 50' Starter hose with 1/4" Snap-Tite Q.D. coupler
- V52533 25' Starter hose with 1/4" Snap-Tite, brass Q.D. coupler
- V55033 50' Starter hose with 1/4" Snap-Tite brass Q.D. coupler

Quick-Disconnect Nipples, Couplers and Adaptors

NIPPLES

1/4" Industrial Interchange

- S9841 With 1/4" Female NPT
- V17 With 3/8" Female NPT

1/4" Schrader

- S19432 With 1/4" Female NPT
- S19433 With 3/8" Female NPT

1/4" Snap-Tite

- S19442 With 1/4" Female NPT
- S17651 With 3/8" Female NPT

Couplers (SHUT-OFF TYPE)

1/4" Industrial Interchange

- V14 With 1/4" Female NPT
- V15 With 3/8" Male NPT

1/4" Schrader

- V18 With 1/4" Female NPT

1/4" Snap-Tite

- V19 With 1/4" Female NPT

HOSE ADAPTORS

- V11 Hose-to-hose, 3/8" hose to 3/8" hose
- V12 Hose-to-pipe, 3/8" hose to 1/4" pipe
- V13 Hose-to-pipe, 3/8" hose to 3/8" pipe

*NOTE

All climate control devices require use of the 20BT breathing tube to constitute complete breathing tube assemblies. Breathing tube must be purchased separately.

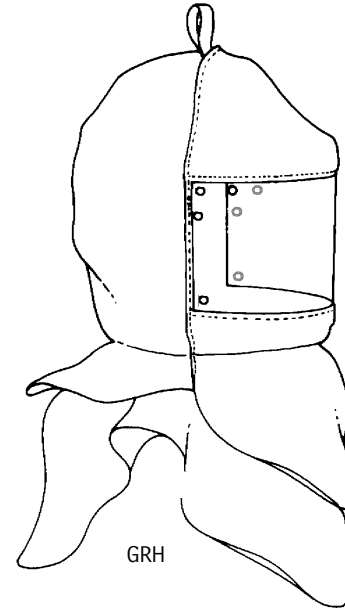

GRH

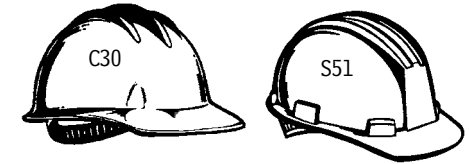

ESRTSL/RS6RC

TGRT600/RS4RP

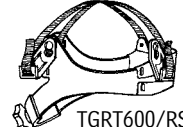

ES-ULTRA/RS6PC

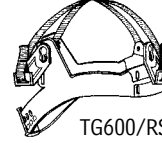

TG600/RS4PP

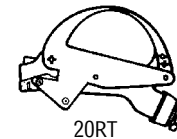

20RT



ES42

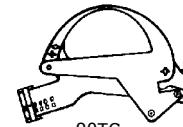

20TG

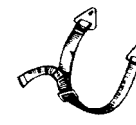

20NC

V30 Series Breathing Tube Assembly

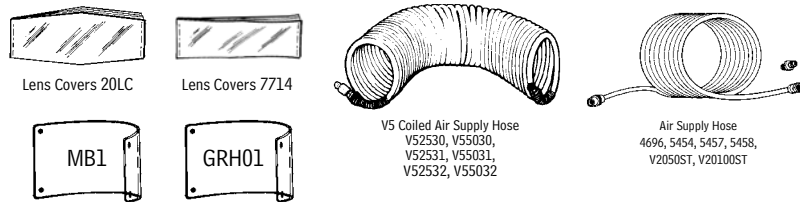
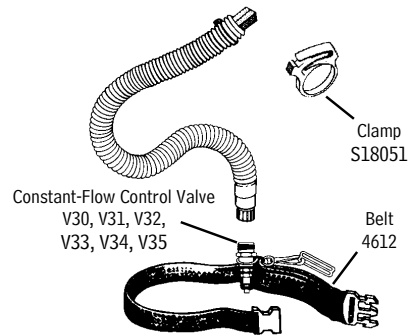

Frigitron® 2000

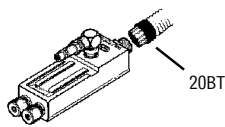

AC1000
AC100031
AC100032

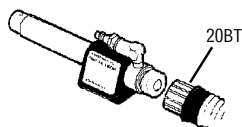

HC2400
HC240031
HC240032

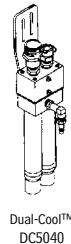
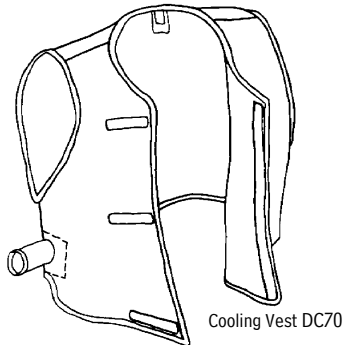
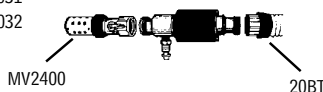

RETURN AUTHORIZATIONS

IMPORTANT: THE FOLLOWING STEPS MUST BE COMPLETED BEFORE E.D. BULLARD COMPANY WILL ACCEPT ANY RETURNED GOODS. PLEASE READ CAREFULLY.

Follow the steps outlined below to return goods to E.D. Bullard Company for repair or replacement under warranty or for paid repairs:

1. Contact your Bullard Customer Service Coordinator by telephone or in writing at:

E.D. Bullard
1898 Safety Way
Cynthiana, KY 41031-9303
Toll-Free: 800-877-BULLARD
Phone: 859-234-6616

In your correspondence or conversation with your Customer Service Coordinator, describe the problem as completely as possible. For your convenience, your coordinator will try to help you correct the problem over the phone.

2. Verify with your coordinator that the product should be returned to Bullard. Customer Service will provide you with written permission and a return authorization number as well as the labels you will need to return the product.
3. Before returning the product, decontaminate and clean it to remove any hazardous materials which may have settled on the product during use. Laws and/or regulations prohibit the shipment of hazardous or contaminated materials. Products suspected to be contaminated will be professionally discarded at the customer's expense.
4. Ship returned products, including those under warranty, with all transportation charges pre-paid. Bullard cannot accept returned goods on a freight collect basis.
5. Returned products will be inspected upon return to the Bullard facility. Your Customer Service Coordinator will telephone you with a quote for required repair work which is not covered by warranty. If the cost of repairs exceeds stated quote by more than 20%, your coordinator will call you for authorization to complete repairs. After repairs are completed and the goods have been returned to you, Bullard will invoice you for actual work performed.



GR50 Series Airline Respirator User Manual



©2010 Bullard. All rights reserved.

6081850020C (1010)

Americas:

E.D. Bullard Company

1898 Safety Way
Cynthiana, KY 41031-9303
Toll free: 877-BULLARD (285-5273)
Tel: 859-234-6616
Fax: 859-234-8987
www.bullard.com

Europe:

Bullard GmbH

Lilienthalstrasse 12
53424 Remagen • Germany
Tel: +49-2642 999980
Fax : +49-2642 9999829
www.bullardextrem.com

Asia-Pacific:

Bullard Asia Pacific Pte. Ltd.

LHK Building
701, Sims Drive, #04-03
Singapore 387383
Tel: +65-6745-0556
Fax: +65-6745-5176
www.bullard.com



EVA Series Powered Air-Purifying Respirator Blower Assembly User Manual

EVA1 - Powered Air-Purifying Respirator

(for use with Loose-Fitting Headtops)

US-NIOSH	Powered Air-Purifying Respirator with High Efficiency (HE) Filters - Approval No. TC-21C-0836 (PAPRFC3)
	Powered Air-Purifying Respirator with OV-AG-HE Filter Cartridges for organic vapors, chlorine, hydrogen chloride, sulfur dioxide, chlorine dioxide, hydrogen fluoride and particulates - Approval No. TC-23C-2510 (PAPRFC4)
	Powered Air-Purifying Respirator with AM-FM-MA-AG-HE Filter Cartridges for ammonia, formaldehyde, methylamine, chlorine, hydrogen chloride, sulfur dioxide, chlorine dioxide, hydrogen fluoride and particulates - Approval No. TC-23C-2886 (PAPRFC5)

EUROPE-EN	CE 0194
	EN 12941 TH3 20TIC, 20SIC, RT3, RT4, 20LFL, 20LFM, 20LF2L, 20LF2M, 20LF2S EN 12941 TH2 20TICH, 20SICH, 20SICVH
	INSPEC
	56 Leslie Hough Way Salford Greater Manchester M6 6AJ United Kingdom



Cautions and Limitations

- A. Not for use in atmospheres containing less than 19.5% oxygen.
 - B. Not for use in atmospheres immediately dangerous to life or health.
 - C. Do not exceed maximum use concentrations established by regulatory standards.
 - F. Do not use respirator if airflow is less than four cfm (115 lpm) for tight fitting face pieces or six cfm (170 lpm) for hoods and/or helmets.
 - H. Follow established cartridge and canister change schedules or observe ESLI to ensure that cartridges and canisters are replaced before breakthrough.
 - I. Contains electrical parts that may cause an ignition in flammable or explosive atmospheres.
 - J. Failure to properly use and maintain this product could result in injury or death.
 - L. Follow the manufacturer's user instructions for changing cartridges and/or filters.
 - M. All approved respirators shall be selected, fitted, used and maintained in accordance with MSHA, OSHA and other applicable regulations.
 - N. Never substitute, modify, add or omit parts. Use only exact Bullard replacement parts in the configuration as specified by the manufacturer.
 - O. Refer to User's Instructions and/or maintenance manuals for information on use and maintenance of these respirators.
 - P. NIOSH does not evaluate respirators for use as surgical masks.
- * At very high work rates, the pressure in the respirator may become negative at peak inhalation flow.

Table of Contents

Warnings, Cautions and Limitations.....	1
Principle of Operation	2
Battery Pack.....	2
Pre-Operational Inspection	3
Mounting the Breathing Tube.....	3
Checking Air Flow	4
Air-Purifying Elements	4
Mounting and Replacing Filter/Cartridges.....	4
Donning the Blower	5

⚠ WARNING

Use strictly in accordance with instructions, labels and limitations pertaining to the EVA Series respirator.

1. The EVA Series respirator does not supply oxygen. Use only in adequately ventilated areas containing at least 19.5% oxygen.
2. Do not use when concentrations of contaminants are immediately dangerous to life or health (IDLH).
This term is defined in 29CFR 1910.134 (b).
3. Do not use these respirators for respiratory protection during abrasive blasting or clean up.
4. Do not use in circumstances where the airborne concentration level of contaminant exceeds maximum use concentration for this type of respirator as established by regulatory standards.
5. Leave area immediately if:
 - Breathing becomes difficult
 - Dizziness or other distress occurs
 - You taste or smell the contaminant
 - Unit becomes damaged
 - Battery alarm activates
 - Low Flow alarm activates
6. This apparatus must not be worn with the blower unit switched off. If the blower is switched off, a rapid build-up of carbon dioxide and depletion of oxygen may occur, which could result in death or serious injury.
7. Never alter or modify this respirator. Use only Bullard NIOSH-approved EVA Series components and replacement parts for this respirator.
8. This device is not immune to highly powered RFI/EMI emissions.
Failure to follow these warnings could result in death or serious injury.

CC20 and GR50 Series Hood Use	5-6
RT Series Hood Use	6
Loose-Fitting Facepiece Use.....	7
Low Battery Alarm	8
Troubleshooting	8
NIOSH Approval Label	9
Cleaning and Storage.....	10
Warranty	10
Ordering Information.....	11

EVA Series - Principle of Operation

The EVA Series Powered Air-Purifying Respirator (PAPR) System is configured in six parts:

- The blower and belt assembly:
 - EVA1 Blower Unit
 - EVABELT1, EVABELT2 - Comfort Belt, Decon Belt
 - PALAFI Air Flow Indicator
- The battery pack (Part No. EVABAT1). One fully charged pack will power the blower for approximately 4 to 10 hours depending upon factors such as speed, cartridge selected and cartridge loading.
- The breathing tube, which is available in three different types and three lengths:
 - PAHBT Powered Air Hood Breathing Tube Assembly (standard length 26")
 - PAHBTXS Powered Air Hood Breathing Tube Assembly (short length 22")
 - PAHBTXL Powered Air Hood Breathing Tube Assembly (long length 32")
 - PA1BT Hood breathing tube assembly with clamp (standard length 26")
 - PA1BTXS Hood breathing tube assembly with clamp (short length 22")
 - PA1BTXL Hood breathing tube assembly with clamp (long length 32")
 - PA20LFBT Loose fitting facepiece breathing tube assembly (standard length 32")
 - PA20LFBTXS Loose fitting facepiece breathing tube assembly (short length 26")
 - PA20LFBTXL Loose fitting facepiece breathing tube assembly (long length 38")
- The High Efficiency Particulate Arrestance (HEPA) filter or chemical filter cartridge.
- The hood with headband suspension (except for the RT Series) and/or hard hat, or loose fitting facepiece. The following hood models may be used with the EVA Series blower unit:
 - GRH/GRHT Grinding hood with inner bib
 - RTL/RTL1T Hood with long inner and outer bib (NIOSH approved for use without a headband suspension)
 - RT2/RT2T Hood with long inner and outer bib (NIOSH approved for use without a headband suspension)
 - RT3/RT3T Hood with long inner and outer bib (NIOSH approved for use without a headband suspension)
 - RT4/RT4T Hood with long inner and outer bib (NIOSH approved for use without a headband suspension)
 - 20TJN/20TJNT Hood
 - 20TICN/20TICNT Hood with inner bib
 - 20TICH/20TICHT Hood for use with Bullard hard hat
 - 20TICSN/20TICSNT Hood with taped and sealed seams
 - 20SICN/20SICNT Hood with taped and sealed seams
 - 20SICVN/20SICVNT Hood with taped and sealed seams and PVC lens
 - 20SICH/20SICHT Hood with taped and sealed seams for use with Bullard hard hat
 - 20SICVH/20SICVHT Hood with taped and sealed seams and PVC lens for use with Bullard hard hat
 - 20LFXL Loose fitting facepiece, extra large size
 - 20LFL Loose fitting facepiece, large size
 - 20LFM Loose fitting facepiece, medium size
 - 20LF2L Loose fitting facepiece (narrow profile), large size
 - 20LF2M Loose fitting facepiece (narrow profile), medium size
 - 20LF2S Loose fitting facepiece (narrow profile), small size
- The Battery Charger:
 - EVASMC Quick charger (single port)
 - EVAGC Gang charger (six port)

The blower unit draws in ambient air through the cartridges. The purified air is blown into the wearer's hood through the breathing tube. A flow indicator is provided to check that there is an adequate volume of air available to the wearer prior to use. The system is designed to operate at a minimum air flow of approximately 7 cubic feet of air per minute (198 liters per minute) in the hood under normal use on the standard speed setting, and 8.5 cubic feet of air per minute (240 liters per minute) in the hood under normal use on the high speed setting. A feedback loop from the Mass Flow Sensor to the impellor continually monitors and adjusts the air flow to keep it constant at the design set point.

The units are designed for use at temperatures from 23°F to 129°F (-5°C to 55°C). The unit will shut down if operated outside this temperature range. A high temperature alarm will sound at 50°C (122°F). The battery pack mounts in a compartment on the back of the blower. A fully charged battery pack will power the blower for approximately 4 to 10 hours depending upon factors such as speed selected, cartridge selected, and filter/cartridge loading.

The EVA Series Blower is equipped with two alarms: A 77 db continuous alarm will sound when the air flow falls below approximately 185 lpm and a 77db intermittent chirp alarm will activate to indicate that the battery has approximately 15 minutes of remaining capacity.

Type C Airline Respirators CC20 Series (TC-19C-0154), RT Series (TC-19C-0412), GRH Series (TC-19C-0329)

Most of the same headpieces approved for use with the CC20, RT, and GR50 Series of supplied air respirators (SAR) are also approved for use with the EVA Series of powered air-purifying respirators. CC20, RT and GR50 Series respirators provide a high level of respiratory protection and user comfort over long work periods, in a wide variety of hazardous environments.

The CC20, RT and GR50 SAR air flow control devices and other components are described in the CC20, RT and GR50 Series User Instructions.

Battery Pack

One fully charged battery pack will power the blower for approximately 4 to 10 hours depending upon factors such as speed selected, cartridge selected and filter/cartridge loading.

NOTE

The battery has built-in short circuit protection. In the event of a short circuit, an internal polyfuse will trip. The fuse will reset itself within 5-10 seconds allowing the battery to resume normal operation.

To charge the battery pack, do the following:

- Press the battery release on the pack to remove the battery from the back of the blower. (See Figure 1.)



Figure 1

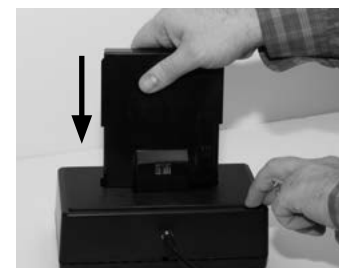

Figure 2

- Connect the battery charger to a 110-volt AC electrical outlet.
- Place battery upside down into the charging port of the battery charger. (Figure 2.)
- Charge the battery pack for approximately 4 hours.

While the battery is charging, the light on the charger will remain red. The charger light will illuminate green when charging is complete.

Table-top gang chargers EVAGC with 6 ports are also available.

EVA Series Powered Air-Purifying Respirator Blower Assembly User Manual

⚠ WARNING

DO NOT charge batteries in hazardous areas.

Battery Storage

Storage of Li Polymer batteries is relatively easy. Unlike Nickel batteries, they lose a very small amount of power (less than 0.5% per day) and therefore can be charged and stored ready for use. If long-term storage is required, it is best to store the battery in a cool place not below -5°C/23°F with at least 40% charge still remaining.

ⓘ NOTE

Discharging and re-charging the battery fully at least once every 3 months is suggested to ensure the longest possible life of the battery. Do not leave on the charger for more than 30 consecutive days.

To maximize battery life, these guidelines should be followed:

- Remove the battery from the blower unit when not in use.
- Charge the battery before it is completely discharged. The low battery alarm indicates that the battery needs to be charged. The battery is designed with a circuit to protect the battery. It will not allow the battery to be discharged below a safe voltage for the cells, regardless of airflow, without the alarm sounding. When the battery reaches the voltage cutoff it will automatically cease operation.
- Always charge the batteries at room temperature or cooler. At higher temperatures, the battery pack may not accept a full charge. If the battery pack feels hot, let it cool for 30 minutes before charging.
- Do not charge battery packs in an enclosed cabinet without ventilation.

Battery Fuel Gauge:

EVA Battery Packs are equipped with an on-board fuel gauge to indicate the amount of remaining capacity left in the battery pack. To check the remaining capacity, simply depress the button labeled "Push" and LEDs will illuminate indicating the level of battery capacity remaining. When fully charged all four LEDs will illuminate green, and when 25% or less charge is available a single LED will illuminate red.



Figure 3

Pre-Operational Inspection

Prior to each work shift, perform the following Pre-Operational Inspection to ensure proper operation and to ensure that the unit is completely assembled.

1. Belt Mounted Blower Unit, Part No. EVA1

- Check that the unit is clean and undamaged.
- Inspect for deterioration, physical damage and improper assembly.

2. Filter/Cartridges

- Inspect the filter/cartridge for any physical damage
- Check the label to ensure the filter/cartridge has not exceeded its "use-by" date.
- Inspect the gasket on the filter for any physical damage.

ⓘ NOTE

Each filter comes with a permanent gasket.

- Ensure that the correct filter/cartridge is appropriate for the contaminant.
- Consult the NIOSH approval label and your own in-plant safety professional if you have any questions as to the suitability and efficiency of the Air-Purifying Element.
- Screw the cartridge into the port until hand-tight and the locking tab is secure. (Refer to Mounting and Replacing Filters on Blower Unit on page 4)

3. Battery Pack

- Check that the battery is not damaged.
- Check the Fuel Gauge to determine sufficient charge is available.
- Place the battery pack in the battery compartment on the blower.
- The battery tab should click when completely engaged. (See Figure 4)

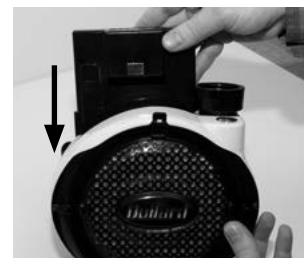

Figure 4

4. Hood with Suspension or Hard Hat, or Loose Fitting Facepiece

- The hood is constructed of one of the following materials: Tychem 2000 (QC), Tychem 4000 (SL) or Nomex (GRH).
- Depending on the model of the hood selected, it may be used with either a headband suspension or a hard hat (Note: RT Series hoods are NIOSH approved without a headband suspension or a hard hat).
- The loose fitting facepiece is constructed of Tychem 2000 (QC) and features an internal suspension.
- Inspect the hood or loose fitting facepiece for any physical damage.

Mounting the Breathing Tube on the Blower

- Ensure that a rubber gasket is in place in the breathing tube coupler on the blower unit.
- Screw one end of the breathing tube into the blower unit. (Hand tight is sufficient.) (See Figure 5)
- Ensure that neither the breathing tube nor the filter is blocked.
- Ensure that the ON/OFF Switch is in the OFF position.
- Switch on the blower by pressing the on/off button for 1-2 seconds confirmed by a short beep.
- If the Low Battery Alarm sounds at this time, the battery needs to be recharged. See instructions on page 2 regarding properly charging the battery.
- If the Low Flow Alarm sounds at this time, the hood, breathing tube and filter should be checked for a blockage.



Figure 5

Checking Airflow with the Airflow Indicator (PA1AFI)

With the blower switched ON and the filters/cartridges mounted, take the free end of the breathing tube in one hand, hold it upright and place the Airflow Indicator into the end of the tube. (See Figure 6).

Apply a light downward pressure to the Airflow Indicator to get a reasonable seal at the breathing tube end. Ensure that the air outlet holes in the Airflow Indicator tube are not blocked. Two hands may be used if preferred, one to hold the breathing tube and one to hold the Airflow Indicator.



Figure 6

The position of the ball in the Airflow Indicator should be observed. If any part of the ball is below the PASS LINE on the Airflow Indicator, check for:

- Blower malfunction.
- Clogged or damaged Air-Purifying filter elements on the HE filter. See "Mounting and Replacing Cartridges on the Blower Unit" on page 4.
- Low battery or battery malfunction.

If the ball is completely above the PASS LINE on the Airflow Indicator, then the system is ready for use.

▲ WARNING

If the blower malfunctions during use in a hazardous area: Remain calm and **LEAVE** the hazardous area immediately. **DO NOT** use a blower that fails the flow test (air flow indicator sold separately). Use **ONLY** Bullard filter/cartridges which comply with and have the NIOSH approval label and which are appropriate for the contaminant. Failure to observe these warnings could result in death or serious injury.

EVA Series PAPR Air-Purifying Elements

Principle of Operation

The following filter/cartridge protection classification applies when used with any of the hoods or loose fitting facepieces.

NIOSH Filter/Cartridges		
Protection	Filter/Cartridge	NIOSH / ANSI Color Code
HE (particulate)	PAPRFC3	Magenta
OV/CL/HC/SD/CD/HF/HE	PAPRFC4	Olive and Magenta
AM/FM/MA/CL/HC/SD/CD/HF/HE	PAPRFC5	Olive and Magenta

EN Filter/Cartridges*		
Protection	Filter/Cartridge	Color Code
EN12941 P3	PAPRFC3	White
A2P3 P3 R S L EN12941	PAPRFC4	White, Brown

▲ WARNING

*The user should not confuse the markings on a filter relating to other standard other than EN 12941 with the classification of this device when used with this filter.

HE particulate filters are 99.97% effective against all particulate aerosols.

The following abbreviations indicate the particulates, gases, or vapors which are removed by the gas/vapor cartridges:

HE-High Efficiency Particulate, OV-Organic Vapor, CL-Chlorine, HC-Hydrogen Chloride, SD-Sulfur Dioxide, CD-Chlorine Dioxide, HF-Hydrogen Fluoride, AM-Ammonia, FM-Formaldehyde, MA-Methylamine

▲ WARNING

Use only the filter/cartridge(s) described in the above table. Do not change cartridges while in a hazardous atmosphere. Incorrect cartridge selection will invalidate all performance statements and approvals for this equipment. Follow established cartridge change schedules to ensure that cartridges are replaced before breakthrough occurs. Failure to follow these warnings could result in death or serious injury. *DO NOT fit filters directly to the hood.

Mounting and Replacing Filters on the Blower Unit

High efficiency particulate filters must be replaced when retained particles clog the filters and reduce air flow below acceptable levels, as indicated by testing with the Air Flow Indicator as described at left.



Figure 7

To Replace Filters

- Remove the air-purifying element from its packaging, and inspect for damage. If in doubt do not use.
- Check that the air-purifying element has not exceeded its "use-by" date.
- Check that the filter connecting thread and gasket are in good condition.
- Check that the air-purifying element is appropriate to the hazard. If in doubt consult your respirator program administrator or supervisor.
- Check that the threads in the blower unit port are in good condition and clear of contaminant.
- Screw the air-purifying elements into the receptacles (see Figure 8) until the cartridge is hand tight. **DO NOT OVERTIGHTEN.**
- Check to see that the locking tab is secure. (see Figure 9)

To Replace Combination Filter/Cartridge

- Follow the steps above, but beware that the filter locking tab is beneath the filter rim. (see Figure 10)



Figure 8



Figure 9



Figure 10

Installing and Removing the Belt on the Blower Unit

To install the belt

- With the blower filter side down, orient the lever locks as shown in Figure 11
- Lay belt over blower as shown in Figure 12
- Rotate level locks until they are oriented as shown in Figure 13



Figure 11



Figure 12



Figure 13

To Remove the Belt

- With the blower filter side down, orient the lever locks as shown in Figure 12
- Remove belt from blower

EVA Series Powered Air-Purifying Respirator Blower Assembly User Manual

NOTE

Plastic insert may be removed for cleaning as shown in Figure 14-15 .
See back page for more information on cleaning.



Figure 14



Figure 15

Donning the Blower and Respirator

Initial Donning

Prepare to don the blower, battery and hood in a safe, hazard-free area and do the following:

- Ensure that the filter/cartridges used are suitable for the contaminant in question and are compatible with the EVA1 Blower Unit.
- Check that the filter/cartridge is properly mounted on the blower unit.
- Place the battery in the battery compartment on the back of the blower.
- Fit the blower and belt around the user's waist and adjust the belt for a comfortable fit (suspenders are also available).
- Remove the belt and blower to install the hood or loose fitting facepiece and corresponding breathing tube.

WARNING

The use of any filter/cartridge not approved with the EVA1 blower unit may put the user at risk and could result in death or serious injury.

Donning the EVA with the CC20 Series or GR50 Series Hood

Adjusting and Installing Headband Suspension in Hood

NOTE

20LF and 20LF2 series loose-fitting facepiece hoods have a sewn-in headband.

NOTE

The 20SICH, 20TICH and GRH Hoods may use a hard hat or suspension.

NOTE

RT Series hoods do not use a suspension.

1. Adjust headband before installing into hood.
2. Turn ratchet until it is at its largest size.
3. Place suspension on head.
4. Adjust ratchet knob until snug and comfortable fit achieved. (Figure 16)
5. Remove from head.
6. Place suspension into hood.

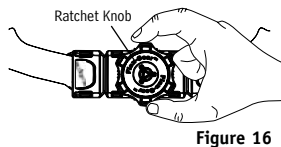

Figure 16

7. Snap 4 white buttons of suspension into 4 white buttons on hood. (Figure 17)



Figure 17

Adjust Crown Straps for Vertical Fit

To improve suspension comfort, adjust crown straps vertically by repositioning the crown strap posts in the crown straps. Vertical adjustment makes the headband ride higher or lower on the wearer's head. To adjust, push crown strap post from slot, move to new slot and snap in to secure. Repeat for other crown strap post (Figure 18).

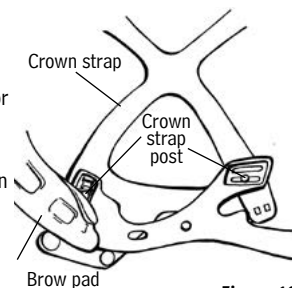

Figure 18

NOTE

If the hood rises off your head during use, first verify proper air pressure, then select a different hood for your application, or use the optional chin strap.

Adjusting and Installing Hard Hat in Respirator Hood (20SICH & 20TICH or GRH)

1. Assemble and adjust the standard Bullard hard hat suspensions RS4PC or RS6PC or the optional ratchet suspensions RS4RC or RS6RC by following the directions on instruction sheet attached to headband on hard hat. Read all hard hat warning labels and instructions. The following Bullard hard hat models are NIOSH approved for use with CC20 Series and GR50 Series respirator hoods: C30, C30R, S51 and S51R.
2. If desired, install and adjust optional ES42 hard hat chinstrap.
3. Before inserting hard hat into hood, remove the two adhesive-backed Velcro® strips attached to the Velcro piece that is sewn into the hood (see Figures 19 & 20).
4. Peel the backing off the longer Velcro tab and apply it to the inside center rear of the hard hat, about 1/4" up from the edge. Apply shorter Velcro tab to the underside of the brim of the hard hat (see Figure 19).
5. Insert hard hat into respirator hood with cap visor facing front of hood (see Figure 19).
6. Tuck cap brim on top of front elastic Velcro band sewn into hood (see Figure 20).
7. Loop the Velcro strip sewn inside the hood around the back of the cap and affix it to the corresponding Velcro tab previously installed inside the hard hat in step 4 (see Figure 21).
8. Remove protective plastic from plastic lens of respirator hood. If desired, apply optional 20LCL adhesive-backed lens covers designed to protect the respirator's plastic lens. Apply 2-3 lenses at a time. When lens becomes soiled, remove by pulling tab at edge of lens cover to clear your vision.



Figure 19

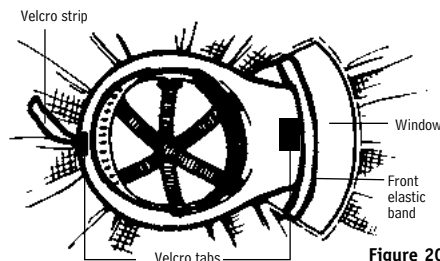

Figure 20

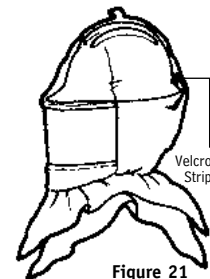

Figure 21

Installing Breathing Tube Assembly in CC20 or GRH Hoods

For hoods without a threaded port at the rear, Breathing Tubes PA1BT, PA1BTXS and PA1BTXL will attach to the hood with a clamp as follows:

1. Remove nylon clamp from plastic anchor plate on hood (see Figure 22).
2. Insert the open end of the breathing tube approximately five inches into hood's air entry sleeve (see Figure 23). Do not insert breathing tube into hood air entry sleeve more than 6 inches as it may cause a flow restriction.
3. Install nylon clamp over air entry sleeve and breathing tube, inserting clamp locks through two holes in plastic anchor plate that is sewn into hood. Locks should face away from user's neck (see Figure 24). The air entry sleeve seams should be on the top and bottom of the breathing tube when properly installed and worn.
4. Engage clamp locks and squeeze together until tight. Air entry sleeve should not be twisted or restricted (see Figure 25). If so, then remove the clamp and repeat steps 2-4.

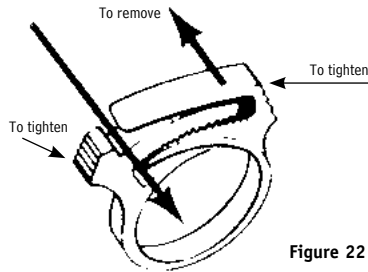

Figure 22

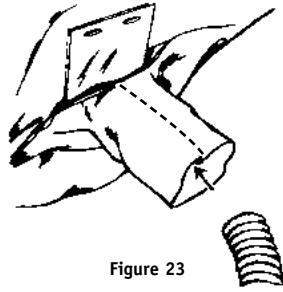

Figure 23

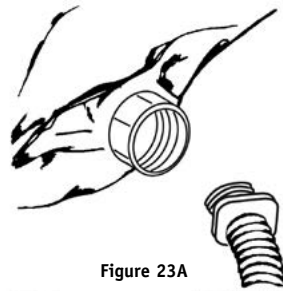

Figure 23A

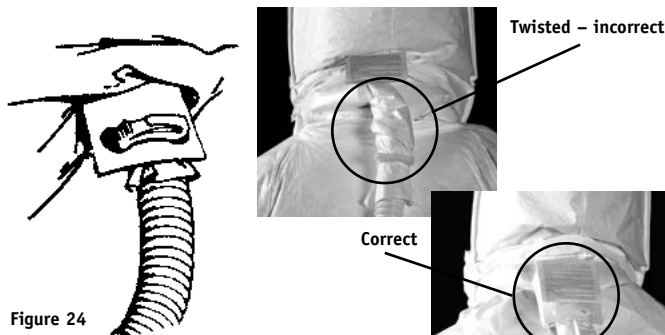

Figure 24

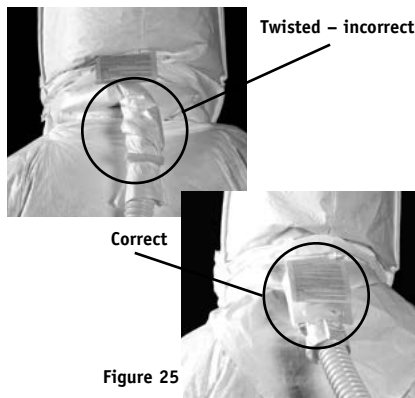

Figure 25

For hoods with a threaded port at the rear (designated with a "T" suffix), Breathing Tubes PAHBT, PAHBTXS, PAHBTXL will attach to the hood by the threading into the port at the rear (See Figure 23A).

4. Tuck inner bib of hood into shirt or protective clothing if using hood with inner bib (see Figure 26).
5. Pull respirator outer bib over collar of shirt or protective clothing.
6. Ensure that the neck cuff is down below the chin and that the air outlets of the cuff (see Figure 27) are not restricted. If the neck cuff is not below the chin, then pull down before continuing (See Figure 28).

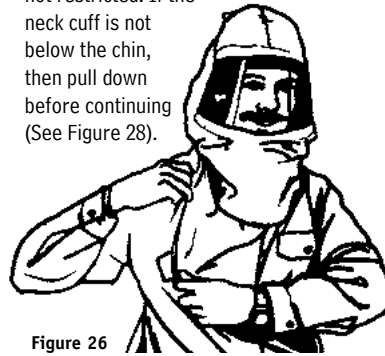

Figure 26

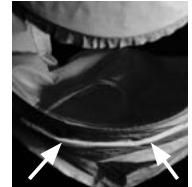

Figure 27



Incorrect



Correct

Figure 28

RT Series Hood Use Installing Breathing Tube Assembly in RT Series Respirator Hoods

For hoods without a threaded port at the rear, Breathing Tubes PA1BT, PA1BTXS and PA1BTXL will attach to the hood with a clamp as follows:

1. Remove nylon clamp from the breathing tube (see Figure 23).
2. Insert the open end of the breathing tube approximately five inches into hood's air entry sleeve (see Figure 29). Do not insert breathing tube into hood air entry sleeve more than 6 inches as it may cause a flow restriction.
3. Install nylon clamp over air entry sleeve and breathing tube. If desired, 2 or more clamps may be used (see Figure 30). The air entry sleeve seams should be on the sides of the breathing tube when properly installed and worn.

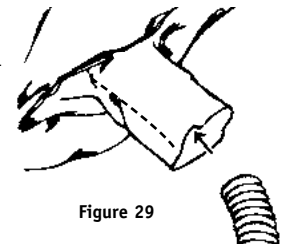

Figure 29

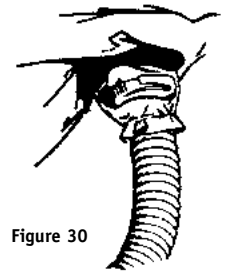

Figure 30

4. Engage clamp locks and squeeze together until tight. Air entry sleeve should not be twisted or restricted (see Figure 31). If so, then remove the clamp and repeat steps 2-4.
5. With PAPR blower unit running, put on RT Series respirator hood. Pull the hood over your head until the neck cuff is securely around your neck.



Twisted - incorrect

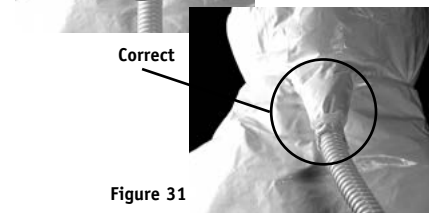

Figure 31

6. Ensure that the neck cuff is down below the chin and that the air outlets of the cuff are not restricted. If the neck cuff (see Figure 27) is not below the chin, then pull down before continuing (See Figure 28).

WARNING

Do not put on or remove these respirators in a hazardous atmosphere except for emergency escape purposes. Failure to heed these warnings could result in death or serious injury.

Donning the CC20 or GRH and EVA

1. With PAPR Blower Unit Running, put on CC20 or GRH Series respirator hood.
2. Position headband suspension or hard hat for a comfortable fit.
3. If using an optional chin strap, pull elastic strap under your chin. Adjust for a secure and comfortable fit.

EVA Series Powered Air-Purifying Respirator Blower Assembly User Manual

⚠ WARNING

The user should ensure that the neck cuff is unrestricted all around the neck to allow proper inflation and reduce restrictions.

Battery run time will be reduced by a restricted or improperly donned hood.

For hoods with a threaded port at the rear (designated with a "T" suffix), Breathing Tubes PAHBT, PAHBTXS, PAHBTXL will attach to the hood by the threading into the port at the rear (See Figure 23A).

ⓘ NOTE

The RT3 and RT4 hoods have an adjustable velcro strap near the top of the lens that allows the user to customize the curvature of the lens to his/her personal preference. This strap may be removed if desired.

7. Make sure that the breathing tube is not twisted after donning.
8. Tuck inner bib of hood into shirt or protective clothing (see Figure 26).
9. Pull respirator outer bib over collar of shirt or protective clothing. Pull the long outer bib down on the outside of clothing and secure with tie down straps or tape (if employer operating procedures will allow.)

Loose-Fitting Facepiece Use Installing Breathing Tube Assembly in Loose- Fitting Facepieces

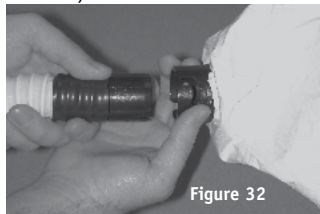

Figure 32

1. The 20LFXL, 20LFL, 20LFM, 20LF2S, 20LF2M and 20LF2L loose-fitting facepieces have a sewn-in breathing tube connector on the back. The PA20LFBT breathing tube has a special connector on the hood end with bayonet type pins.
2. Insert the bayonet connector of the PA20LFBT breathing tube in the hood connector and turn clockwise until it locks in place (see Figure 32).

Available in extra large 20LFXL, large 20LF2L or 20LFL, medium 20LF2M or 20LFM, and small 20LF2S. Select the size that fits most comfortably and matches your head size. Remove the protective cover from the visor. Pull the hood over your head and adjust the headband around your head and the elasticized edge of the facepiece under your chin. Make sure that the breathing tube is not twisted after donning.

Final Donning:

- Attach the other end of breathing tube to blower unit (if not already attached) by screwing adapters together.
- Remove any protective film covering the lens of the headpiece.
- Put on the belt and blower assembly and make any final adjustments to the belt as necessary, keeping the breathing tube and hood behind the head.
- Turn the blower on by depressing and holding the on/off switch (Figure 33) for approximately 1 second indicated by a short beep.
- Buckle the belt onto the waist (blower unit should be in the lower back of the wearer).
- Don the headpiece.
- Choose speed setting (see below).
- Place the hood on the head making any final adjustments to the fit as required at this time to ensure a comfortable and stable fit.
- Tuck inner bib into coveralls or shirt if using a hood with inner bib.

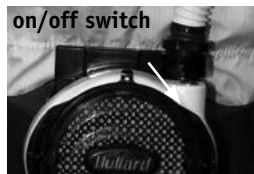

Figure 33

⚠ WARNING

Do not enter a hazardous area until you are sure that the blower and hood are fully operational and the blower is running. The user should periodically leave the hazardous area to check the airflow through the system. If the low battery or low flow alarm should sound, or if the user experiences any difficulty in breathing, or senses any taste or any odors from the hazard, the user should leave the hazardous area immediately. Failure to observe these warnings could result in death or serious injury.

Final Donning

	Front	Back
CC20 Single Bib		
CC20 Double Bib		
RT Series		
20LFL		
20LF2L		
GRH		

Speed Selection

The EVA1 Blower is equipped with the ability for the user to select one of two speeds for operation.

When the unit is initially turned on, the blower will operate at approximately 8.5 cfm = 240 lpm (high speed). Note: The battery life is reduced at the higher speed. Pressing the on/off switch will change the speed to approximately 7 cfm = 198 lpm (low speed).

Pressing the on/off switch additional times will toggle the unit between the two speeds.

ⓘ NOTE

Speed change is confirmed by a short beep.

Low Battery Alarm and Low Flow Alarm

The EVA1 Blower unit is equipped with a Low Battery Alarm and a Low Flow Alarm.

The Low Battery Alarm will sound an intermittent 77 dba electronic beep indicating that there are approximately 15 minutes of remaining battery capacity. The delays between beeps will get shorter and shorter as time runs out.

The Low Flow Alarm will sound a continuous 77 dba electronic beep indicating that the flow to the hood has dropped below the design specification of 185 lpm = 6.5 CFM (Note: The NIOSH minimum required flow is 170 lpm = 6 CFM).

When either of these alarms sounds, the user should immediately do the following:

- Leave the hazard area

- Remove the headpiece

- Disconnect the breathing tube from the hood

- Check the airflow with the airflow indicator (see page 4).

- Check the operation of the low-flow alarm by blocking the end of the breathing tube. The device will first ramp up to compensate and if correct flow cannot be achieved, the alarm will sound within 5 seconds.

If the airflow indicator indicates insufficient airflow, the battery should be fully charged (see "Battery Pack" on page 2), and/or the filter/cartridge should be replaced.

NOTE

The EVA1 blower is provided with a circuit to protect the battery. It will not allow the battery to be discharged below a safe voltage for the cells, regardless of airflow, without the Alarm sounding. When the battery reaches the voltage cutoff it will automatically cease operation. When the Low Battery Alarm sounds and the filter cartridges are not clogged, the battery should be recharged to protect the battery and thereby prolong the working life of the unit. If the ball in the Airflow Indicator is BELOW or PARTLY BELOW the PASS LINE with a fully charged battery, the filter cartridges may need to be changed.

Doffing the Respirator

Prepare to doff the blower, battery and hood in a safe, hazard-free area and do the following (in conjunction with your employer's standard operating procedures):

- Remove the hood.
- Turn the blower off by holding down the on/off switch for 5 seconds. This is confirmed by a long beep and a shut down of the motor.
- Remove the waist belt.
- Disconnect the hood from the breathing tube.
- Disconnect the breathing tube from the blower.
- Clean and inspect components as necessary.
- Place battery on charger (as desired).
- Place components in storage.

WARNING

The use of any filter/cartridge not approved with the EVA1 blower unit may put the user at risk and could result in death or serious injury.

Troubleshooting

The following guide will assist you in troubleshooting to locate possible issues with your respirator:

Circumstance	Possible Cause(s)	Solution
Low Battery Alarm is sounding	Low Voltage	Charge the battery
	Blower malfunction	Return blower for analysis
Low Flow Alarm is sounding	Clogged/damaged air-purifying filter element	Replace the filter/cartridge
	Battery Low	Re-charge the battery
	Blower malfunction	Leave hazardous area immediately and check equipment. If the problem persists and no damage is found, return equipment for repair. Replace breathing tube and/or hood.
	Hood neck cuff is restricting flow	Adjust neck cuff position
Smell or taste contaminant	Equipment damaged	Leave hazardous area immediately and check equipment
	Filter needs to be replaced	Replace filter
	Low airflow	Leave hazardous area immediately and check equipment If the problem persists and no damage is found, return equipment for repair
Blower unit does not run full service life	Damaged Battery	Return battery for analysis
	Malfunctioning Battery Charger	Return charger for analysis
	Hood neck cuff is restricting flow	Adjust neck cuff position



Cleaning

▲ WARNING

Avoid contaminant entry into the breathing tube, as this will compromise respiratory protection and could result in death or serious injury. Consult your local safety professional if you suspect that contaminant has entered the breathing tube.

When cleaning the equipment, do the following:

- Ensure water does not enter filter/cartridges. Replace wet filter/cartridges.
- DO NOT use gasoline, organic-based solvents, or chlorinated degreasing fluids (such as trichloroethylene), as they will cause damage.
- DO NOT immerse the equipment in water or other cleaning fluid, as this may cause contamination in the breathing tube and blower interior that will be difficult to remove.
- Use a lint-free cloth moistened in a mild solution of soap and warm water to clean the outer surface of the equipment.

Failure to observe the instructions and warnings in this manual invalidates all performance statements and approvals for this equipment and could result in death or serious injury.

The following chemicals have been tested and approved as cleaning agents for the blower housing, belt and battery:

- A. Process NPD (L.256) from Steris
- B. Spor Klenz (undiluted) from Steris
- C. Clorox liquid bleach at 10% concentration
- D. Sani-Cloth HB wipes
- E. 100% Methanol
- F. 70% IPA

Once filter/cartridges have reached the end of their useful life, discard in accordance with federal, state, and local guidelines, and in conformance with plant safety regulations.

Consult the appropriate CC20, RT or GR50 Series Hood User Manual for cleaning instructions for the hood components.

Storage

When the blower is completely dry, store in a clean, dry area, away from direct sunlight and sources of direct heat.

The storage temperature should be between 23° F to 129° F (-5° C to 54° C) with humidity less than 90% RH.

Consult the appropriate CC20, RT or GR50 Series Hood User Manual for storage instructions on hood components

One Year Limited Warranty

Bullard warrants to the original purchaser that the EVA Powered Air-Purifying Respirator and Loose-Fitting Facepiece or Hood will be free of defects in material and workmanship under normal use and service for a period of one (1) year from the date of purchase. Bullard's obligation under this warranty is limited to repairing or replacing, at its option, articles that are returned within the warranty period and that are, after examination, shown to Bullard's satisfaction to be defective, subject to the following limitations;

- a) EVA Powered Air-Purifying Respirator and Loose-Fitting Facepiece or Hood must be returned to the Bullard factory with shipping charges prepaid.
- b) EVA Powered Air-Purifying Respirator and Loose-Fitting Facepiece or Hood must not be altered from its original factory configuration.
- c) EVA Powered Air-Purifying Respirator and Loose-Fitting Facepiece or Hood must not have been misused, subjected to negligent use, or damaged in transport.
- d) The date of purchase is within the one year warranty period. (A copy of the purchaser's original invoice showing the date of purchase is required to validate warranty coverage.)

In no event shall Bullard be responsible for damages for loss of use or other indirect, incidental, consequential or special costs, expenses or damages incurred by the purchaser, notwithstanding that Bullard has been advised of the possibility of such damages.

ANY IMPLIED WARRANTIES, INCLUDING WARRANTIES OF MERCHANTABILITY AND FITNESS FOR A PARTICULAR PURPOSE, ARE LIMITED IN DURATION TO ONE (1) YEAR FROM THE DATE OF PURCHASE OF THIS PRODUCT.

Some states do not allow the exclusion or limitation of incidental or consequential damages, or allow limitations on how long an implied warranty lasts, so the above limitations or exclusion may not apply to you. This warranty gives you specific legal rights, and you may have other rights which vary from state to state.

Return Authorization

The following steps must be completed before Bullard will accept any returned goods. Please read carefully.

Follow the steps outlined below to return goods to Bullard for repair or replacement under warranty or for paid repairs:

1. Contact Bullard Sales Support by telephone or in writing at:

Bullard
1898 Safety Way
Cynthiana, KY 41031-9303
Toll-free: 877-BULLARD (285-5273)
Phone: 859-234-6616

In your correspondence or conversation with Sales Support, describe the problem as completely as possible. For your convenience, your sales support specialist will try to help you correct the problem over the phone.

2. Verify with your sales support specialist that the product should be returned to Bullard. Sales Support will provide you with written permission and a return authorization number as well as the labels you will need to return the product.
3. Before returning the product, decontaminate and clean it to remove any hazardous materials which may have settled on the product during use. Laws and/or regulations prohibit the shipment of hazardous or contaminated materials. Products suspected to be contaminated will be professionally discarded at the customer's expense.
4. Ship products to be returned, including those under warranty, with all transportation charges pre-paid. Bullard cannot accept returned goods on a freight collect basis.
5. Returned products will be inspected upon return to the Bullard facility. Bullard Sales Support will telephone you with a quote for required repair work which is not covered by warranty. If the cost of repairs exceeds stated quote by more than 20%, your sales support specialist will call you for authorization to complete repairs. After repairs are completed and the goods have been returned to you, Bullard will invoice you for actual work performed.

EVA Series Powered Air-Purifying Respirator Blower Assembly User Manual

Ordering Information

Blower Assemblies

EVA1	Blower unit only
EVA2	Blower unit, battery and charger, belt
EVA3	Blower unit, battery and belt

Replacement Batteries and Chargers

EVASMC	Quick charger (1 port)
EVAGC	Table top gang charger for EVABAT1 (6 ports)
EVABAT1	Lithium Polymer Battery Pack (black)

Replacement Cartridges

PAPRFC3	HE (6 per box)
PAPRFC4	OV/AG/HE (6 per box)
PAPRFC5	AM/FM/MA/AG/HE (6 per box)

Respirator Hoods

Single bib hood, for use with headband suspension*

20TJ/20TJT	Tychem 2000 (QC) 20RT headband suspension
20TJN/20TJNT	Tychem 2000 (QC) No headband suspension

Double bib hood for use with headband suspension*

20TIC/20TICT	Tychem 2000 (QC) 20RT headband suspension
20TICN/20TICNT	Tychem 2000 (QC) No headband suspension
20TICS/20TICST	Tychem 2000 (QC) 20RT headband suspension, taped and sealed seams
20TICSN/20TICSNT	Tychem 2000 (QC) No headband suspension, taped and sealed seams
20SIC/20SICT	Tychem 4000 (SL) 20RT headband suspension, taped and sealed seams
20SICN/20SICNT	Tychem 4000 (SL) No headband suspension, taped and sealed seams
20SICV/20SICVT	Tychem 4000 (SL) 20RT headband suspension, taped and sealed seams, PVC lens
20SICVN/20SICVNT	Tychem 4000 (SL) No headband suspension, taped and sealed seams, PVC lens

Double bib hood for use with Bullard hard hat*

20TICH/20TICHT	Tychem 2000 (QC) Hard hat not included
20SICH/20SICHT	Tychem 4000 (SL) Hard hat not included, taped and sealed seams
20SICVH/20SICVHT	Tychem 4000 (SL) Hard hat not included, taped and sealed seams, PVC lens

Double bib grinding hood for use with Bullard hard hat or suspension*

GRH/GRHT	Nomex, Hard hat not included
----------	------------------------------

Loose fitting facepieces with sewn-in suspension

20LFXL	Tychem 2000 (QC), Extra Large
20LFL	Tychem 2000 (QC), Large
20LFM	Tychem 2000 (QC), Medium
20LF2S	Tychem 2000 (QC), Small, narrow profile
20LF2M	Tychem 2000 (QC), Medium, narrow profile
20LF2S	Tychem 2000 (QC), Large, narrow profile

Double bib hood for use without a headband suspension*

RT1/RT1T	Tychem 2000 (QC), Inflatable Neck Collar
RT2/RT2T	Tychem 4000 (SL), Inflatable Neck Collar
RT3/RT3T	Tychem 2000 (QC), Sport Neck Collar
RT4/RT4T	Tychem 4000 (SL), Sport Neck Collar

* "T" Suffix designates thread connection

Accessory Items for Hoods

20LCL	Mylar lens covers, CC20 Series (25/pkg)
RTLC	Mylar lens covers, RT Series (25/pkg)
MB1	Outer lens, GRH Series (10/pkg)
20LC	Mylar lens covers, GRH Series (25/pkg)

Headband Suspensions and Hard Hats

20TG	Standard headband suspension
20RT	Sure-Lock® ratchet headband suspension
30WHP	Hard hat with standard suspension, white
30WHR	Hard hat with ratchet suspension, white
51WHP	Hard hat with standard suspension, white
51WHR	Hard hat with ratchet suspension, white

Accessories for Headbands Suspension and Hard Hats

RS6PC	Standard replacement suspension for 30WHP hard hat
RS6RC	Replacement ratchet suspension for 30WHR hard hat
RS4PC	Standard replacement suspension for 51WHP hard hat
RS4RC	Replacement ratchet suspension for 51WHR hard hat
20NC	Chinstrap for 20TG and 20RT headband suspension
ES42	Chinstrap for C30 and S51 hard hats

Replacement Parts and Accessories

EVABELT1	Replacement belt
EVABELT2	Vinyl replacement belt
EVAEXT1	Extension belt kit
PAPRSUSP1	PAPR suspenders (1 pair)
PA1AFI	Air flow indicator
PAHBT	Powered air hood breathing tube assembly; standard length
PAHBTXS	Powered air hood breathing tube assembly; short length
PAHBTXL	Powered air hood breathing tube assembly; long length
PA1BT	Hood breathing tube assembly; includes tube and clamp; standard length
PA1BTXS	Hood breathing tube assembly; includes tube and clamp; short length
PA1BTXL	Hood breathing tube assembly; includes tube and clamp; long length
PA20LFBT	Loose fitting facepiece breathing tube assembly; standard length
PA20LFBTXS	Loose fitting facepiece breathing tube assembly; short length
PA20LFBTXL	Loose fitting facepiece breathing tube assembly; long length
PA1BTS	Breathing tube/cartridge seal
S18051	Breathing tube clamp (10/pack)



Americas:
Bullard
1898 Safety Way
Cynthiana, KY 41031-9303
Toll free: 877-BULLARD (285-5273)
Tel: 859-234-6616
Fax: 859-234-8987

Europe:
Bullard GmbH
Lilienthalstrasse 12
53424 Remagen • Germany
Tel: +49-2642 999980
Fax : +49-2642 9999829

Asia-Pacific:
Bullard Asia Pacific Pte. Ltd.
LHK Building
701, Sims Drive, #04-03
Singapore 387383
Tel: +65-6745-0556
Fax: +65-6745-5176



©2017 Bullard. All rights reserved.