

# Audo

COPENHAGEN



REVERSE TABLE LAMP  
Designed by *Aleksandar Lazic*



## REVERSE TABLE LAMP

Designed by *Aleksandar Lazic*

Table lamp with conical travertine base and bronzed anodised aluminium shade. A dimmer switch fitted on top of the lamp controls the dim to warm LED light.

The Reverse Table Lamp is sold included five interchangeable plugs suitable for North America, Australia, China, Europe and the UK.



REVERSE TABLE LAMP, BRONZED BRASS  
1410619Y

PRODUCT TYPE  
Table lamp

COLLI  
2

ENVIRONMENT  
Indoor

DIMENSIONS  
H: 30 cm / 11,8"  
Ø: 24 / 10 cm / 9,4" / 3,9"

PRODUCTION PROCESS  
Spun aluminium shade with anodized colour, milled aluminium knob, and hand-cut and raw polished travertine base.

COLOUR  
Beige and bronzed brass.

MATERIALS  
Travertine, aluminium, PMMA, adaptor with CE, UL and GB plug.

### TECHNICAL SPECIFICATIONS

WEIGHT  
3,64 kg / 5,7 lb

VOLTAGE  
110 - 240 V, adaptor input 24 V

LIGHT SOURCE  
Built-in LED

LIGHT SPECIFICATION  
6 W  
330 lm  
2200 - 3000 K  
RA > 85  
Energy class: G

DIMMER  
Yes, on top of shade.

CANOPY  
N / A

CORD MATERIAL AND COLOUR  
Flexible PVC cable, black, plug, black.

CORD LENGTH  
200 cm / 78,7"

CLASSIFICATION  
IP20, Class II

CERTIFICATIONS  
CE and ETL certified, tests can be obtained upon request.

PACKAGING TYPE  
Gift box

PACKAGING MEASUREMENTS  
(H × W × D)  
36,5 cm × 31 cm × 32,5 cm /  
14,4" × 12,2" × 12,8"

MATERIALS & MAINTENANCE  
Please visit [audocph.com](http://audocph.com) for materials, care and maintenance instructions.

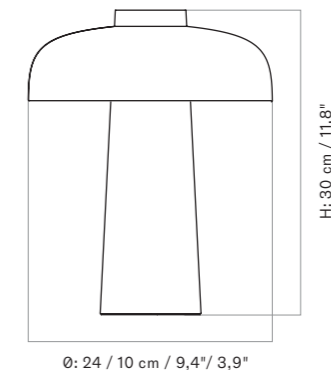

# Audo

COPENHAGEN

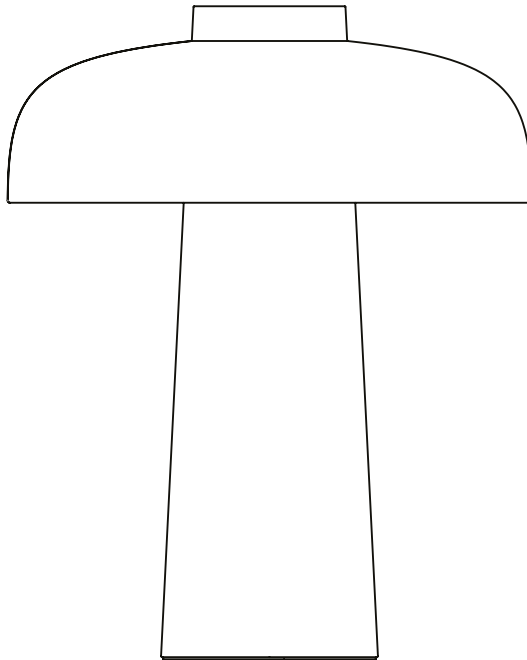

REVERSE TABLE LAMP  
Design by *Aleksandar Lazic*

Congratulations on your new REVERSE TABLE LAMP designed by *Aleksandar Lazic* for Audo Copenhagen. We hope you will enjoy using it.

Please follow these instructions carefully to ensure the safe and correct installation of your new lamp.

感谢您购买由 Aleksandar Lazic 设计的 REVERSE TABLE 台灯, 希望您会喜欢此产品, 并依照这份说明以确保正确安装产品。

为了您的安全, 在使用产品之前, 请您仔细阅读本产品说明书。

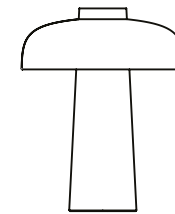

1 × Lamp

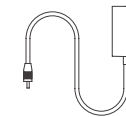

1 × Transformer



4 × Plugs

*Note*

Contact a qualified electrician if you experience any issues during installation. The external cable cannot be replaced. If damaged, it must be replaced only by the manufacturer, their service agent or another qualified individual.

注意事项

如果您在安装过程中遇到任何问题, 请联系专业的电工。  
此灯具的电源线不能替换; 如有损坏, 请联系制造商、服务代理或由专业的电工替换。

### Warning

Improper installation, adjustment, alteration, service, maintenance or use can cause personal injury or property damage. Before installing, always turn off the power for the circuit.

### 警语

不正确的产品安装、调整、改造、维护或使用不当,可能会导致您的人身伤害或财产损失。因此安装前,请务必关闭电路电源。

### Caution

Keep this product and its packaging out of children's reach.

### 安全注意

请将本产品及其包装放置于儿童接触不到的地方。

### Disposal

At the end of its life, dispose of this lamp in the correct waste bin or at a recycling station. Do not discard as household waste. Your local authority can provide further information on where and how it can be disposed of. The EU Waste from Electrical and Electronic Equipment (WEEE) Directive 2005 encourages the recycling of this item.

### 回收处理方式

此产品使用寿命结束时,将此灯丢弃在正确的垃圾箱或回收站。请勿作为生活垃圾丢弃。查询您的地方当局所提供有关如何处置它的方式及更多信息。2005年欧盟废弃电子电机设备指令(WEEE)鼓励回收该物品。

### US version only

### IMPORTANT SAFETY INSTRUCTIONS:

This portable lamp has a polarized plug (one blade is wider than the other) as a feature to reduce the risk of electric shock. This plug will fit in a polarized outlet only one way. If the plug does not fit fully in the outlet, reverse the plug.

If it still does not fit, contact a qualified electrician. Never use with an extension cord unless plug can be fully inserted. DO NOT ALTER PLUG.

### INSTRUCTIONS IMPORTANTES DE SÉCURITÉ

Ce luminaire portable a une fiche polarisée (une lame est plus large que l'autre) comme une caractéristique pour réduire le risque de choc électrique insérer cette fiche dans une prise polarisée à sens unique Si la fiche ne correspond pas, complètement dans la prise, inverser la fiche. Si elle ne rentre toujours pas, contactez un électricien qualifié. ne jamais utiliser avec une rallonge à moins que la fiche peut être insérée à fond. ne pas modifier la fiche."

### Technical Specification

### Reverse Table Lamp

Intergrated LED PCB  
Dimmable

Watt: 9 Lumen: 445  
Kelvin: 2500 K CRI: >90  
Energy Class: G

The Intergrated LED PCB is replaceable.

Plaease check our website or contact our sale support



1

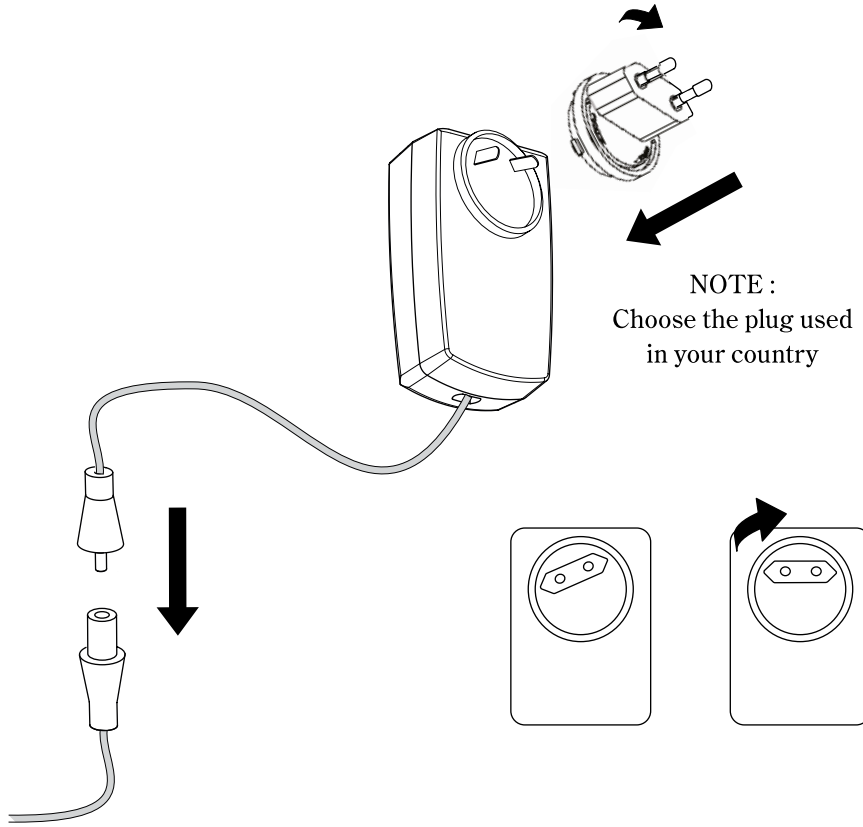

2

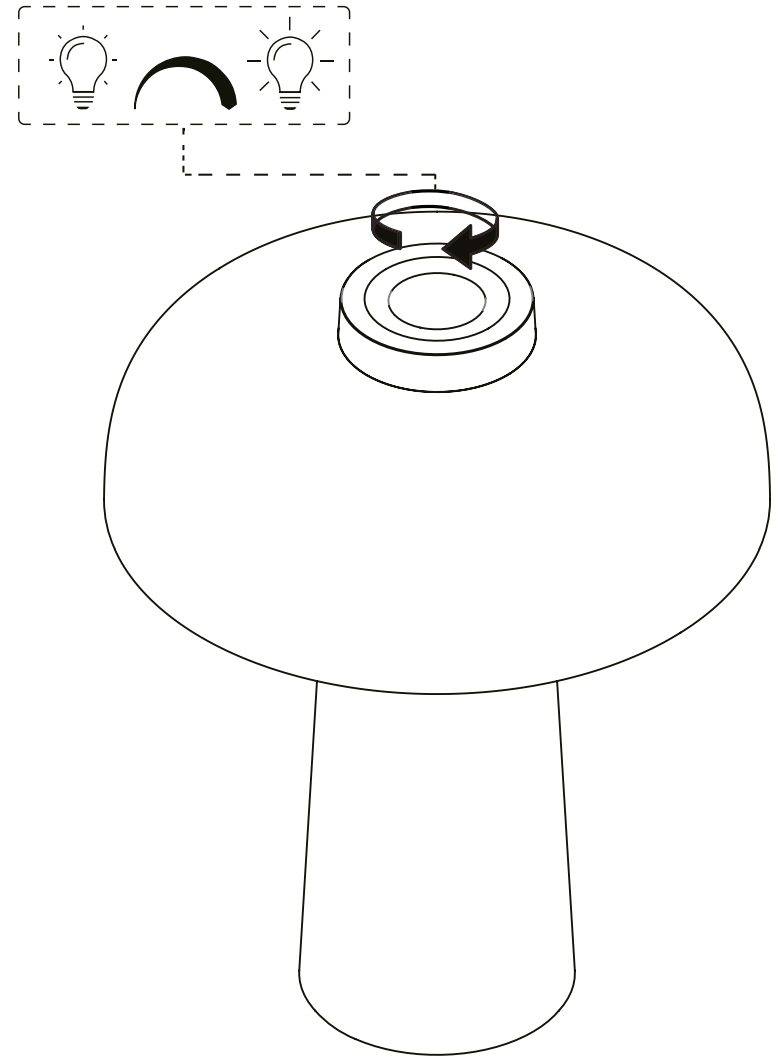

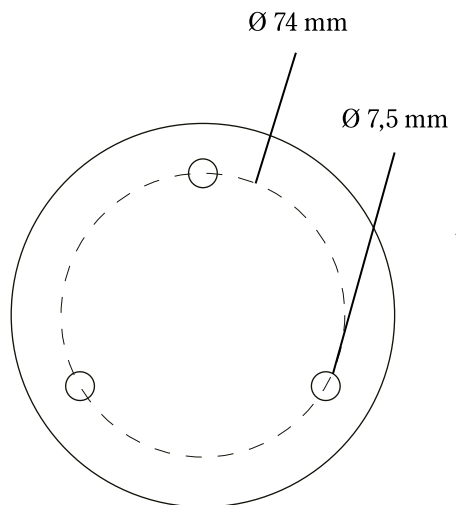
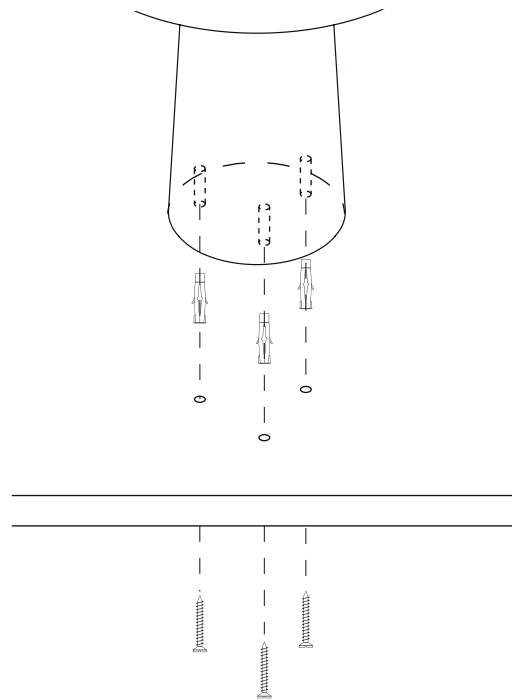

**NOTE :**  
Underneath the base there are 3 holes in order  
to use plastic plugs /screw and secure  
the lamp to a table top.  
The holes are 7,5 mm in diamter and 30mm  
depth.  
Please use appropriate plughs and screws.





