

Paramount Large Square Ottoman

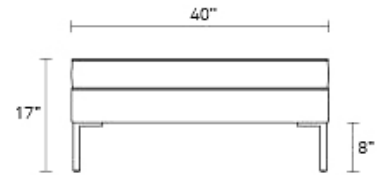

Generously proportioned ottoman, gargantuan coffee table, square crash pad - it is up to you. Tufted top stitching keeps things tailored, while ample cushioning provides a soft sit. Sleeps several small children. Shop the entire Paramount Collection

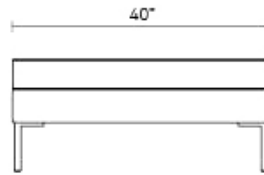

LIBBY
CHARCOAL

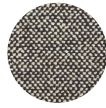

SANFORD
BLACK

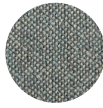

SANFORD
CERAMIC

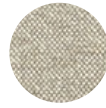

SANFORD
OATMEAL



OTTER
VELVET

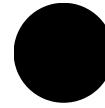

METAL



STAINLESS
STEEL

Product Details

- Tufted top cushion
- Stainless steel or blackened metal finish steel legs
- Sanford Black / Sanford Ceramic / Sanford Oatmeal : 63% Polyester / 37% Acrylic blend upholstery | 50,000 Double Rubs
- Libby Charcoal: 90% Polyester / 10% Linen blend upholstery | 85,000 Double Rubs
- Otter Velvet: 67% Polyester / 33% Acrylic blend upholstery | 70,000 Double Rubs
- BIFMA rated
- Some assembly required

PM1-SQOTOS-CL

PM1-SQOTOA-CL

PM1-SQOTOS-BK

PM1-SQOTOA-BK

PM1-SQOTOS-CE

PM1-SQOTOA-CE

PM1-SQOTOS-OA

PM1-SQOTOA-OA

PM1-SQOTOA-OV

PM1-SQOTOS-OV

LIBBY CHARCOAL / STAINLESS STEEL

LIBBY CHARCOAL / METAL

SANFORD BLACK / STAINLESS STEEL

SANFORD BLACK / METAL

SANFORD CERAMIC / STAINLESS STEEL

SANFORD CERAMIC / METAL

SANFORD OATMEAL / STAINLESS STEEL

SANFORD OATMEAL / METAL

OTTER VELVET / METAL

OTTER VELVET / STAINLESS STEEL

\$1,099.00

\$1,099.00

\$1,099.00

\$1,099.00

\$1,099.00

\$1,099.00

\$1,099.00

\$1,099.00

\$1,299.00

\$1,299.00

Are you a trade professional? Visit bludot.com/trade-contract



Paramount Lounge Chair

As comfortable as your favorite jeans. As versatile as a little black dress. This classic lounge can go anywhere in style but don't be surprised if it steals the limelight in its own quiet way. Shop the entire Paramount Collection

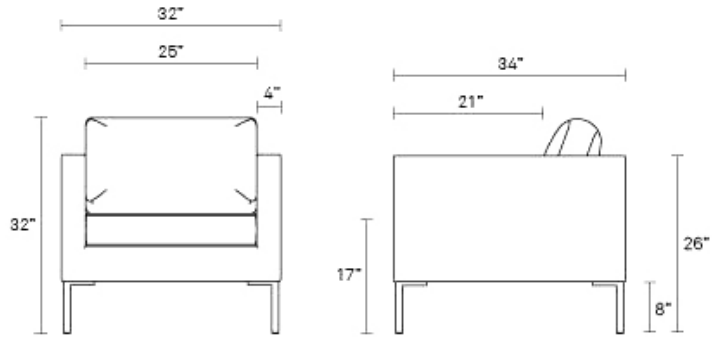

Product Details

- Solid hardwood and wood frame
- Tufted seat cushion
- Loose back cushions
- Stainless steel or blackened metal finish steel legs
- Sanford Black / Sanford Ceramic / Sanford Oatmeal : 63% Polyester / 37% Acrylic blend upholstery | 50,000 Double Rubs
- Libby Charcoal: 90% Polyester / 10% Linen blend upholstery | 85,000 Double Rubs
- Otter Velvet: 67% Polyester / 33% Acrylic blend upholstery | 70,000 Double Rubs
- BIFMA rated
- Some assembly required

PM1-LNGCHS-CL	LIBBY CHARCOAL / STAINLESS STEEL	\$1,199.00
PM1-LNGCHA-CL	LIBBY CHARCOAL / METAL	\$1,199.00
PM1-LNGCHS-BK	SANFORD BLACK / STAINLESS STEEL	\$1,199.00
PM1-LNGCHA-BK	SANFORD BLACK / METAL	\$1,199.00
PM1-LNGCHS-CE	SANFORD CERAMIC / STAINLESS STEEL	\$1,199.00
PM1-LNGCHA-CE	SANFORD CERAMIC / METAL	\$1,199.00
PM1-LNGCHS-OA	SANFORD OATMEAL / STAINLESS STEEL	\$1,199.00
PM1-LNGCHA-OA	SANFORD OATMEAL / METAL	\$1,199.00
PM1-LNGCHS-OV	OTTER VELVET / STAINLESS STEEL	\$1,399.00
PM1-LNGCHA-OV	OTTER VELVET / METAL	\$1,399.00

Are you a trade professional? Visit bludot.com/trade-contract