

HermanMiller Collection

Nelson® Saucer® Bubble Pendant



Designer

George Nelson

Original Production Date

1952

Warranty

1 year

The Nelson Saucer Bubble Pendant's wide surface area diffuses soft light into any interior. It comes with a steel ceiling plate, which allows it to delicately float overhead. George Nelson originally designed the Bubble Lamp series in 1952, inspired by a set of silk-covered Swedish hanging lamps.

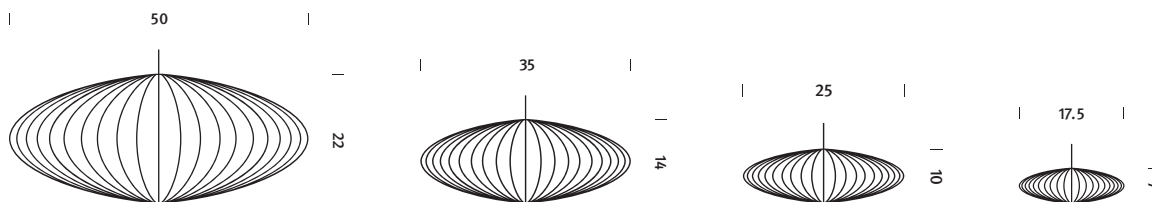

HermanMiller Collection

Nelson® Saucer® CrissCross® Bubble Pendant



Designer

George Nelson

Original Production Date

1952

Warranty

1 year

The Nelson Saucer CrissCross Bubble Pendant is part of the Nelson Bubble Lamp series. Inspired by a set of silk-covered Swedish hanging lamps, George Nelson designed the series in 1952. Beyond the soft light this lamp casts, it features a unique crisscross pattern that adds an interesting contour to the shade.

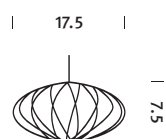
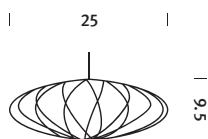

HermanMiller Collection

Nelson® Orbit™ Bubble Pendant

**Designer**

George Nelson

Original Production Date

1952

Warranty

1 year

The Nelson Orbit Bubble Pendant has a striking presence with its recognizable but inimitable shape. This sculptural pendant light comes in two sizes and has a unique steel understructure. It also includes a ceiling plate and an adjustable 10-foot cord. We worked with the George Nelson Foundation to reintroduce this archival shape in 2018.

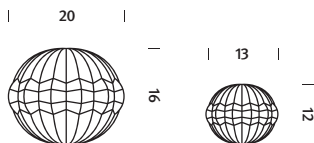

HermanMiller Collection

Nelson® Cigar® Bubble Pendant



Designer

George Nelson

Original Production Date

1952

Warranty

1 year

Part of the Nelson Bubble Lamp series, the Nelson Cigar Bubble Pendant has the rounded shape of its namesake, with clean parallel lines accentuating its spherical silhouette. The lamp comes with a steel ceiling plate, which allows it to delicately float overhead. George Nelson designed the Bubble Lamp series in 1952.

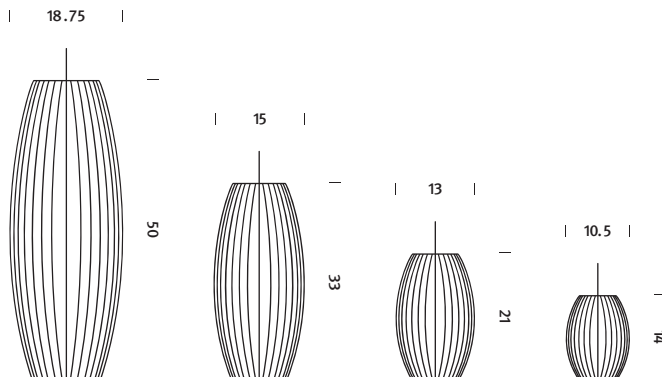

HermanMiller Collection

Nelson® Roll Bubble Pendant

**Designer**

George Nelson

Original Production Date

1952

Warranty

1 year

The Nelson Roll Bubble Pendant illuminates any room with a soft, warm glow. With a silhouette softer than a square, its cylindrical form gently floats from the ceiling on an adjustable-length 10-foot cord. The Roll shape was added to the series in 2018 after being rediscovered in the George Nelson Foundation archives.

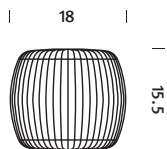

HermanMiller Collection

Nelson® Ball Bubble Pendant



Designer

George Nelson

Original Production Date

1952

Warranty

1 year

The Nelson Ball Bubble Pendant is a full, perfectly round sphere that fills any interior with a warm, diffused light. A steel ceiling plate allows it to delicately float overhead. George Nelson was inspired by a set of silk-covered Swedish hanging lamps when he originally designed the Bubble Lamp series in 1952.

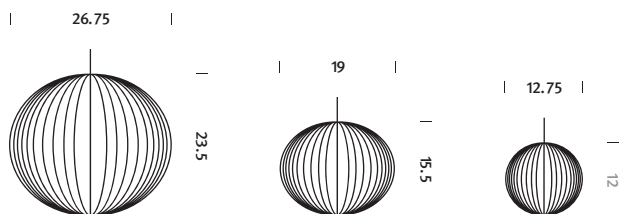

HermanMiller Collection

Nelson® Angled Sphere Bubble Pendant



Designer
George Nelson

Original Production Date
1952

Warranty
1 year

The gently angled lines of its steel understructure bring a unique, yet familiar shape into any interior. This pendant comes in three sizes complete with a ceiling plate and an adjustable 10-foot cord. The Nelson Angled Sphere Bubble Pendant was rediscovered in the George Nelson Foundation archives and reintroduced in 2018.

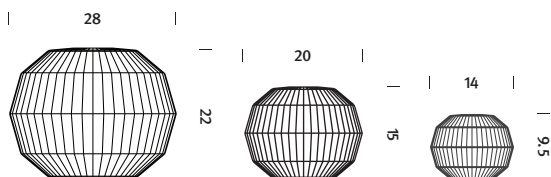

HermanMiller Collection

Nelson® Pear® Bubble Pendant



Designer

George Nelson

Original Production Date

1952

Warranty

1 year

Part of the Nelson Bubble Lamp series, the Nelson Pear Bubble Pendant recalls the fruit's shape in the way it flares towards the center. The parallel lines of the lamp's lightweight steel frame are visible along its surface. The lamp casts a soft, even light. George Nelson designed the Bubble Lamp series in 1952.

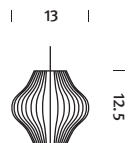

HermanMiller Collection

Nelson® Apple™ Bubble Pendant

**Designer**

George Nelson

Original Production Date

1952

Warranty

1 year

Part of the Nelson Bubble Lamp series, the Nelson Apple Bubble Pendant has a clean, rounded symmetry. It comes with a steel ceiling plate, from where it floats overhead, casting a soft, even light. George Nelson designed the series in 1952. He was inspired by a set of silk-covered Swedish hanging lamps.

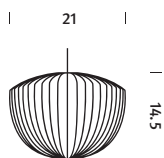

HermanMiller Collection

Nelson® Propeller® Bubble Pendant

**Designer**

George Nelson

Original Production Date

1952

Warranty

1 year

Part of the Nelson Bubble Lamp series, the Nelson Propeller Bubble Pendant has a sculpted quality with angular twists in its shade. It's designed to delicately float overhead and add charm and personality to any room. George Nelson designed the series in 1952. He was inspired by a set of silk-covered Swedish hanging lamps.

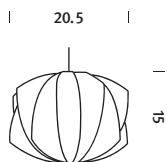

HermanMiller Collection

Nelson® Ball CrissCross® Bubble Pendant



Designer

George Nelson

Original Production Date

1952

Warranty

1 year

The Nelson CrissCross Bubble Pendant is one of the Nelson Bubble Lamp series, a group of lighting fixtures in charming spherical shapes. The crisscross pattern of the lamp's structure adds an interesting dimensionality and soft light to any interior. George Nelson, inspired by a set of silk-covered Swedish hanging lamps, designed the series in 1952.

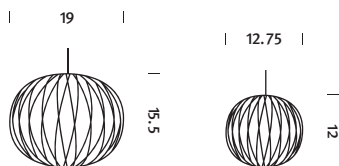

HermanMiller Collection

Nelson® Triple Bubble Lamp Fixture

**Designer**

George Nelson

Original Production Date

1952

Warranty

1 year

Part of the Nelson Bubble Lamp series, the Nelson Triple Bubble Lamp Fixture provides the structure to hold a playful trio of Bubble Lamps, sold separately. When equipped with shades, the assemblage brings light and playfulness to any space. George Nelson, inspired by a set of silk-covered Swedish hanging lamps, designed the series in 1952.



| 14.5 |



HermanMiller Collection

Nelson® Cigar® CrissCross® Bubble Pendant



Designer

George Nelson

Original Production Date

1952

Warranty

1 year

The Nelson Cigar CrissCross Bubble Pendant is part the Nelson Bubble Lamp series, a group of lighting fixtures in charming, spherical shapes. The elongated sphere of this lamp has an interesting crisscross pattern in its underlying structure. George Nelson, inspired by a set of silk-covered Swedish hanging lamps, designed the series in 1952.

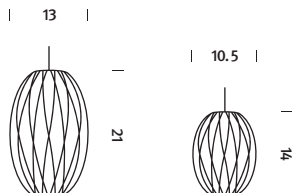

HermanMiller Collection

Nelson® Pear® CrissCross® Bubble Pendant



Designer

George Nelson

Original Production Date

1952

Warranty

1 year

Part of the Nelson Bubble Lamp series, the Nelson Pear Bubble Pendant has a pear shape that flares towards the center, with crisscrossing lines in the understructure that accentuate its curves. George Nelson originally designed the Bubble Lamp series in 1952. He was inspired by a set of silk-covered Swedish hanging lamps.

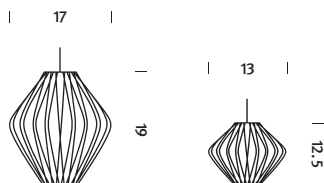

HermanMiller Collection

Nelson® Lantern Bubble Pendant



Designer

George Nelson

Original Production Date

1952

Warranty

1 year

The Nelson Lantern Bubble Pendant is part of the Nelson Bubble Lamp series, a group of lighting fixtures in elegant, spherical silhouettes. The pendant echoes the traditional lantern shape, transforming it into a minimal expression for contemporary spaces. George Nelson, inspired by a set of silk-covered Swedish hanging lamps, designed the series in 1952.



| 11 |



| 10.5 |

HermanMiller Collection

Nelson® Bell® Bubble Pendant



Designer

George Nelson

Original Production Date

1952

Warranty

1 year

The Nelson Bell Bubble Pendant is part of the Nelson Bubble Lamp series, a group of lamps in elegant, spherical silhouettes. This extra-large light fills a space in soft, diffused light as it floats overhead, hung from a steel ceiling plate. George Nelson, inspired by a set of silk-covered Swedish hanging lamps, designed the series in 1952.

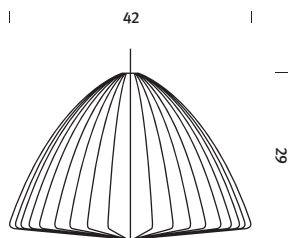

HermanMiller Collection

Nelson® Cigar® Lotus Table Lamp

**Designer**

George Nelson

Original Production Date

1952

Warranty

1 year

Part of the Nelson Bubble Lamp series, the Nelson Cigar Lotus Table Lamp has a rounded shape with clean parallel lines accentuating its elongated sphere. Mounted on a steel base, with or without walnut cover, the lamp disperses a soft light. George Nelson, inspired by a set of silk-covered Swedish hanging lamps, designed the series in 1952.



HermanMiller Collection

Nelson® Pear® Lotus Table Lamp



Designer

George Nelson

Original Production Date

1952

Warranty

1 year

Part of the Nelson Bubble Lamp series collection, the Nelson Pear Lotus Table Lamp flares at the center. The lamp's lightweight steel frame is seen as parallel lines along its surface. Perfect for a table setting, the lamp has a steel base, with or without walnut cover, and an easy-to-use pull chain with a solid walnut end.

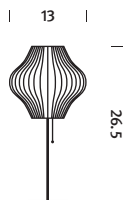

HermanMiller Collection

Nelson® Ball Lotus Table Lamp



Designer

George Nelson

Original Production Date

1952

Warranty

1 year

The Nelson Ball Lotus Table Lamp is part of the Nelson Bubble Lamp series. Mounted on a steel base, with or without walnut cover, the charming sphere fills interiors with a warm, diffused light. George Nelson, inspired by a set of silk-covered Swedish hanging lamps, originally designed the Bubble Lamp series in 1952.



HermanMiller Collection

Nelson® Cigar® Lotus Floor Lamp



Designer
George Nelson

Original Production Date
1952

Warranty
1 year

Part of the Nelson Bubble Lamp series collection, the Nelson Cigar Lotus Floor Lamp has a rounded shape with clean parallel lines accentuating its elongated sphere. Affixed to a steel stand, with or without walnut cover, it disperses a soft light to any space. George Nelson, inspired by a set of silk-covered Swedish hanging lamps, designed the series in 1952.

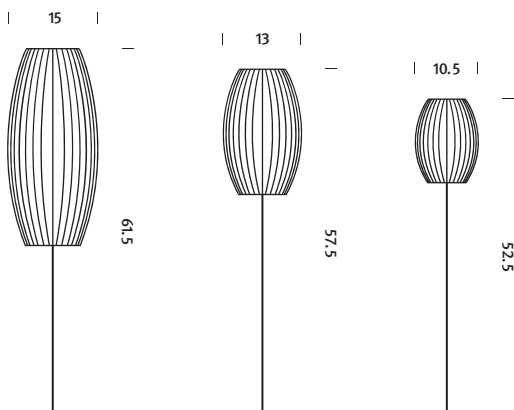

HermanMiller Collection

Nelson® Pear® Lotus Floor Lamp



Designer

George Nelson

Original Production Date

1952

Warranty

1 year

Part of the Nelson Bubble Lamp series, the Nelson Pear Lotus Floor Lamp has a shape that flares at the center. Affixed to a steel lamp stand, with or without walnut cover, it illuminates any room with a soft, warm glow. George Nelson designed the series in 1952. He was inspired by a set of silk-covered Swedish hanging lamps.

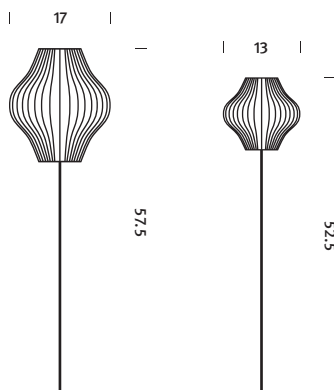

HermanMiller Collection

Nelson® Cigar® Tripod Lamp



Designer

George Nelson

Original Production Date

1952

Warranty

1 year

Part of the Nelson Bubble Lamp series, the Nelson Cigar Tripod Lamp has a rounded shape with clean parallel lines accentuating its elongated sphere. Set on a steel tripod, it disperses a soft light within any space. George Nelson, inspired by a set of silk-covered Swedish hanging lamps, designed the series in 1952.

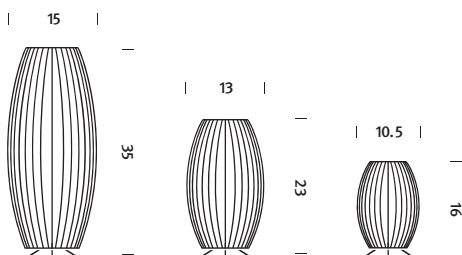

HermanMiller Collection

Nelson® Pear® Tripod Lamp



Designer

George Nelson

Original Production Date

1952

Warranty

1 year

Part of the Nelson Bubble Lamp series, the Nelson Pear Tripod Lamp has a shape that flares at the center. Set on a steel tripod base, it illuminates any room in a soft, warm glow. George Nelson designed the Bubble Lamp series in 1952. He was inspired by a set of silk-covered Swedish hanging lamps.

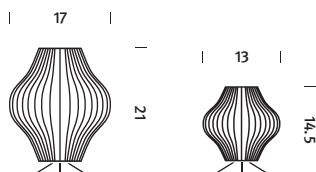

HermanMiller Collection

Nelson® Ball Tripod Lamp

**Designer**

George Nelson

Original Production Date

1952

Warranty

1 year

The Nelson Ball Tripod Lamp is part of the Nelson Bubble Lamp series. Set on a steel tripod base, it fills interiors with a warm, diffused light. George Nelson, inspired by a set of silk-covered Swedish hanging lamps, originally designed the Bubble Lamp series in 1952.



| 12.75 |



| 14 |

HermanMiller Collection

Nelson® Lantern Tripod Lamp



Designer

George Nelson

Original Production Date

1952

Warranty

1 year

The Nelson Lantern Tripod Lamp is part of the Nelson Bubble Lamp series, a group of lighting fixtures in elegant, spherical silhouettes. Set atop a steel tripod, it echoes the classic lantern shape, transforming it into a minimal expression for contemporary spaces. George Nelson originally designed the series in 1952.



HermanMiller Collection

Nelson® Ball Wall Sconce



Designer

George Nelson

Original Production Date

1952

Warranty

1 year

The Nelson Ball Wall Sconce is part of the Nelson Bubble Lamp series. A walnut wall mount and steel arm suspends the spherical shade and lets the lamp fill any interior with a warm, diffused light. The lamp's arm can be adjusted from left to right and up and down without having to change its position on the wall.

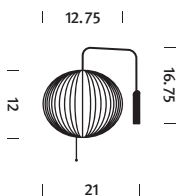

HermanMiller Collection

Nelson® Saucer® Wall Sconce



Designer

George Nelson

Original Production Date

1952

Warranty

1 year

The Nelson Saucer Wall Sconce is part of the Nelson Bubble Lamp series. A walnut wall mount and steel arm attach the wide, saucer-shaped shade to a wall, filling any interior with a warm, diffused light. The arm can be adjusted left to right and up and down, without having to change its position on the wall.

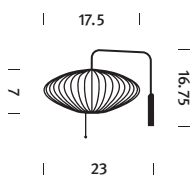

HermanMiller Collection

Nelson® Cigar® Wall Sconce



Designer

George Nelson

Original Production Date

1952

Warranty

1 year

The Nelson Cigar Wall Sconce is part of the Nelson Bubble Lamp series. A walnut wall mount and steel arm attach the elongated, spherical shade to a wall, filling any interior with a warm, diffused light. The arm can be adjusted left to right and up and down, without having to change its position on the wall.

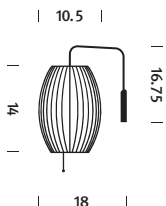

HermanMiller Collection

Nelson® Pear® Wall Sconce



Designer

George Nelson

Original Production Date

1952

Warranty

1 year

Part of the Nelson Bubble Lamp series, the Nelson Pear Wall Sconce has a shape that flares at the center. A walnut wall mount and steel arm attach the elongated, spherical shade to a wall, filling any interior with a warm, diffused light. The arm can be adjusted left to right and up and down, without having to change its position on the wall.

