

Audo

COPENHAGEN



HARBOUR COLUMN TABLE COLLECTION
Designed by *Norm Architects*

PRODUCT OPTIONS

Tabletop

BLACK PAINTED OAK



CHARCOAL LINOLEUM



ESTREMOZ MARBLE

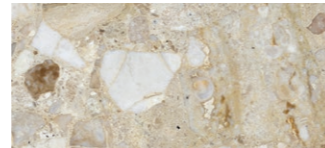

KUNIS BRECCIA STONE

BaseBLACK POWDER COATED
ALUMINIUM & STEEL

Black powder coated aluminium and steel base with round or rectangular tabletop in Kunis Breccia stone, Estremoz marble, black painted oak or linoleum.



PRODUCT TYPE
Dining table

COLLI
1

ENVIRONMENT
Indoor

DIMENSIONS

70 × 60
H: 73 cm / 28,7"
W: 70 cm / 27,6"
D: 60 cm / 23,6"

Ø60
H: 73 cm / 28,7"
Ø: 60 cm / 23,6"

Ø80
H: 73 cm / 28,7"
Ø: 80 cm / 31,5"

Ø105
H: 73 cm / 28,7"
Ø: 105 cm / 41,3"

PRODUCTION PROCESS

Both base and top plate for mounting the tabletop to the base are made from flame-cut steel. The column is made of extruded aluminium. Tabletops are CNC milled and Kunis Breccia stone and Estremoz marble versions are treated with a sealer.

Being composed of a natural material, each product is unique and the surface may nuance compared to the images.

COLOUR

Tabletop
Black (RAL 9005)
Charcoal (RAL 7012)
Off white (Estremoz marble)
Sand (Kunis Breccia stone)

Base
Black (RAL 9005)

TECHNICAL SPECIFICATIONS

GLOSS
Gloss 10-20

MATERIALS

Tabletop
Kunis Breccia stone, Estremoz marble, MDF and forbo linoleum or MDF and painted oak veneer

Topplate
Powder coated steel

Base
Cast, extruded aluminium, steel

WEIGHT

Tabletop oak or linoleum
70 × 60: 8,5 kg / 18,7 lb
Ø60: 8 kg / 17,6 lb
Ø80: 9 kg / 19,8 lb

Tabletop marble or stone
70 × 60: 36 kg / 79,4 lb
Ø60: 28 kg / 61,7 lb
Ø80: 52,8 kg / 116,4 lb
Ø105: 80 kg / 176,4 lb

Topplate
6,4 kg / 14,1 lb

Column
2,4 kg / 5,3 lb

Base
Ø50: 12,9 kg / 28,4 lb
Ø70: 25,3 kg / 55,8 lb

TEST
EN 15372:2016, L2

CERTIFICATIONS
TSCA title VI compliant

PACKAGING TYPE
Brown box

PACKAGING MEASUREMENTS
(H × W × D)

Tabletop oak or linoleum 70 × 60
6 cm × 75 cm × 65 cm /
2,4" × 29,5" × 25,6"

Tabletop marble or stone 70 × 60
80 cm × 70 cm × 10 cm /
31,5" × 27,6" × 4"

Tabletop oak or linoleum Ø60
6 cm × 65 cm × 65 cm /
2,4" × 25,6" × 25,6"

Tabletop marble or stone Ø60
70 cm × 70 cm × 10 cm /
27,6" × 27,6" × 4"

Tabletop oak or linoleum Ø80
6 cm × 85 cm × 85 cm /
2,4" × 33,5" × 33,5"

Tabletop marble or stone Ø80
90 cm × 90 cm × 10 cm /
35,4" × 35,4" × 4"

Tabletop marble or stone Ø105
115 cm × 115 cm × 10 cm /
42,3" × 42,3" × 4"

Topplate
6 cm × 48 cm × 48 cm /
2,4" × 18,9" × 18,9"

Column (H × Ø)
75 cm × 7 cm /
29,5" × 2,8"

Base Ø50
6 cm × 58 cm × 58 cm /
2,4" × 22,8" × 22,8"

Base Ø70
6 cm × 80 cm × 80 cm /
2,4" × 31,5" × 31,5"

MATERIALS & MAINTENANCE
Please visit audocph.com for materials, care and maintenance instructions.

TECHNICAL SPECIFICATIONS

TECHNICAL SPECIFICATIONS

Harbour column dining table, 70 × 60

Harbour column dining table, Ø60

Harbour column dining table, Ø80

Harbour column dining table, Ø105

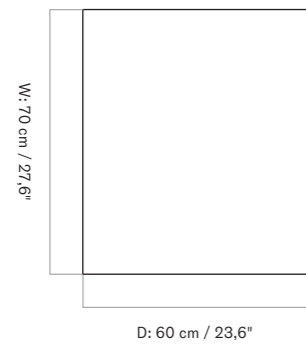

D: 60 cm / 23,6"

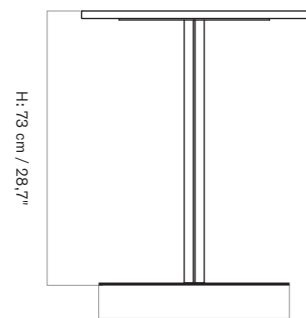

Ø: 50 cm / 19,7"

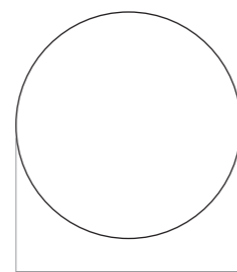

Ø: 60 cm / 23,6"

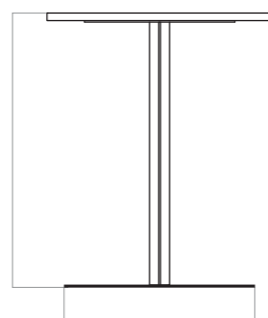

Ø: 50 cm / 19,7"

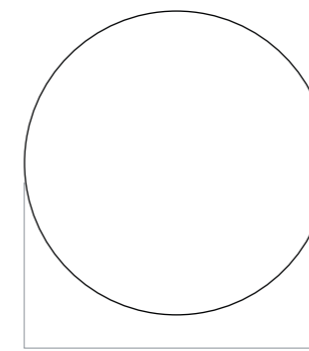

Ø: 80 cm / 31,5"

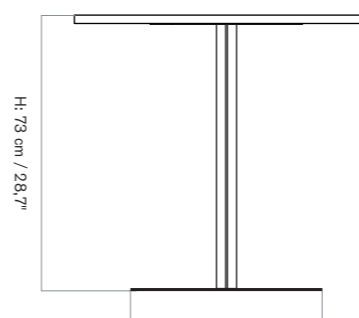

Ø: 50 cm / 19,7"

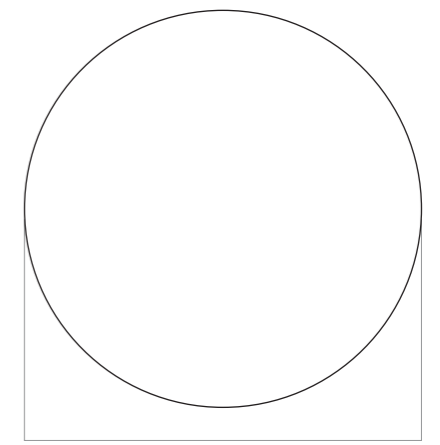

Ø: 105 cm / 41,3"

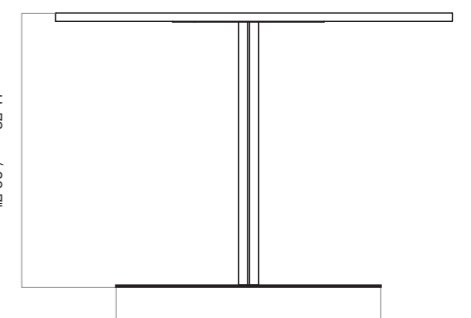

Ø: 70 cm / 27,6"



HARBOUR COLUMN DINING TABLE, STAR BASE
Designed by *Norm Architects*

Star-shaped, black powder coated aluminium and steel base with round or rectangular tabletop in Kunis Breccia stone, Estremoz marble, black painted oak or linoleum.



Tabletop



BLACK PAINTED OAK



CHARCOAL LINOLEUM



ESTREMOZ MARBLE



KUNIS BRECCIA STONE

Base



BLACK POWDER COATED
ALUMINIUM & STEEL

PRODUCT TYPE
Dining table

COLLI
1

ENVIRONMENT
Indoor

DIMENSIONS

70 × 60
H: 73 cm / 28,7"
W: 70 cm / 27,6"
D: 60 cm / 23,6"

Ø60
H: 73 cm / 28,7"
Ø: 60 cm / 23,6"

Ø80
H: 73 cm / 28,7"
Ø: 80 cm / 31,5"

PRODUCTION PROCESS

Star base is made of die casted aluminium and column is made of extruded aluminium. The top plate for mounting the tabletop to the base is made from flame cut steel. Tabletops are CNC milled and Kunis Breccia stone and Estremoz marble versions are treated with a sealer.

Being composed of a natural material, each product is unique and the surface may nuance compared to the images.

MATERIALS

Tabletop
Kunis Breccia stone, Estremoz marble, MDF and forbo linoleum or MDF and painted oak veneer

Base
Cast, extruded aluminium, steel

TECHNICAL SPECIFICATIONS

COLOUR

Tabletop
Black (RAL 9005)
Charcoal (RAL 7012)
Off white (Estremoz marble)
Sand (Kunis Breccia stone)

Topplate
Powder coated steel

Base
Black (RAL 9005)

GLOSS
Gloss 10-20

WEIGHT

Tabletop oak or linoleum
70 × 60: 8,5 kg / 18,7 lb
Ø60: 8 kg / 17,6 lb
Ø80: 9 kg / 19,8 lb

Tabletop marble or stone
70 × 60: 36 kg / 79,4 lb
Ø60: 28 kg / 61,7 lb
Ø80: 52,8 kg / 116,4 lb

Topplate
6,4 kg / 14,1 lb

Column
1,8 kg / 4 lb

Star base
3,5 kg / 7,7 lb

TEST
EN 15372:2016, L2

CERTIFICATIONS
TSCA title VI compliant

PACKAGING TYPE
Brown box

PACKAGING MEASUREMENTS
(H × W × D)

Tabletop oak or linoleum 70 × 60
6 cm × 75 cm × 65 cm /
2,4" × 29,5" × 25,6"

Tabletop marble or stone 70 × 60
80 cm × 70 cm × 10 cm /
31,5" × 27,6" × 4"

Tabletop oak or linoleum Ø60
6 cm × 65 cm × 65 cm /
2,4" × 25,6" × 25,6"

Tabletop marble or stone Ø60
70 cm × 70 cm × 10 cm /
27,6" × 27,6" × 4"

Tabletop oak or linoleum Ø80
6 cm × 85 cm × 85 cm /
2,4" × 33,5" × 33,5"

Tabletop marble or stone Ø80
90 cm × 90 cm × 10 cm /
35,4" × 35,4" × 4"

Topplate
6 cm × 48 cm × 48 cm /
2,4" × 18,9" × 18,9"

Column (H × Ø)
55 cm × 7 cm /
21,7" × 2,8"

Star base
22 cm × 51 cm × 51 cm /
8,7" × 20,1" × 20,1"

MATERIALS & MAINTENANCE
Please visit audocph.com for materials, care and maintenance instructions.



HARBOUR COLUMN DINING TABLE, STAR BASE
Designed by *Norm Architects*

TECHNICAL SPECIFICATIONS

70 × 60

Ø60

Ø80

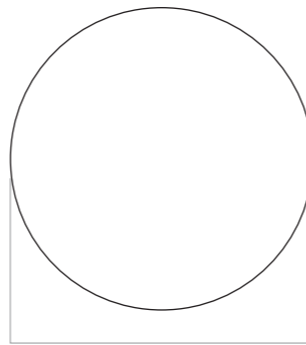
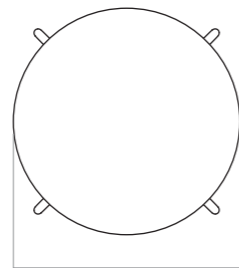
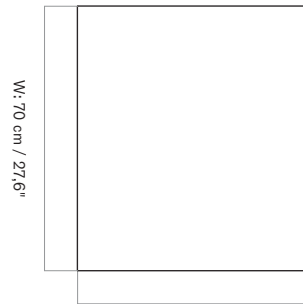

W: 70 cm / 27,6"

D: 60 cm / 23,6"

Ø: 60 cm / 23,6"

Ø: 80 cm / 31,5"

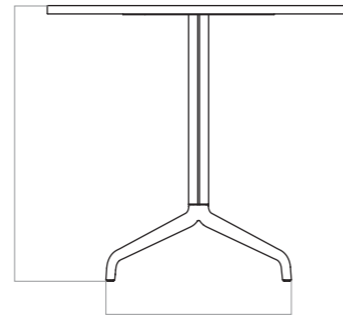
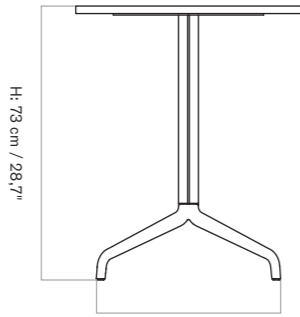
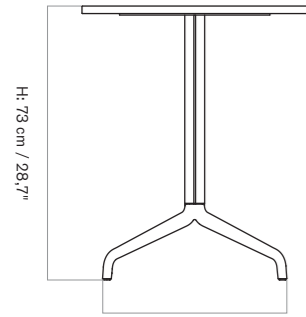

H: 73 cm / 28,7"

H: 73 cm / 28,7"

H: 73 cm / 28,7"

D/W: 49 cm / 19,3"

D/W: 49 cm / 19,3"

D/W: 49 cm / 19,3"



Black powder coated aluminium and steel base with round or rectangular tabletop in Kunis breccia stone, Estremoz marble, Black painted oak or linoleum.



PRODUCT OPTIONS

Tabletop

BLACK PAINTED OAK

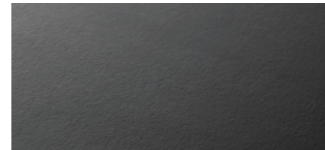

CHARCOAL LINOLEUM



ESTREMOZ MARBLE



KUNIS BRECCIA STONE

BaseBLACK POWDER COATED
ALUMINIUM & STEEL

PRODUCT TYPE
Counter and bar table

COLLI
1

Environment
Indoor

DIMENSIONS

70 × 60
H: 93 cm / 36,6"
W: 70 cm / 27,6"
D: 60 cm / 23,6"

Ø60
H: 93 cm / 36,6"
Ø: 60 cm / 23,6"

Ø80
H: 93 cm / 36,6"
Ø: 80 cm / 31,5"

PRODUCTION PROCESS

Both base and top plate for mounting the tabletop to the base are made from flame-cut steel. The column is made of extruded aluminium. Tabletops are CNC milled and Kunis breccia stone and Estremoz marble versions are treated with a sealer.

Being composed of a natural material, each product is unique and the surface may nuance compared to the images.

COLOUR

Tabletop
Black (RAL 9005)
Charcoal (RAL 7012)
Off white (Estremoz marble)
Sand (Kunis breccia stone)

Base
Black (RAL 9005)

TECHNICAL SPECIFICATIONS

GLOSS
Gloss 10-20

MATERIALS

Tabletop
Kunis breccia stone, Estremoz marble, MDF and forbo linoleum or MDF and painted oak veneer

Topplate
Powder coated steel

Base
Cast, extruded aluminium, steel

WEIGHT

Tabletop oak or linoleum
Ø60: 8 kg / 17,6 lb
Ø80: 9 kg / 19,8 lb
70 × 60: 8,5 kg / 18,7 lb

Tabletop marble or stone
Ø60: 28 kg / 61,7 lb
Ø80: 52,8 kg / 116,4 lb
70 × 60: 36 kg / 79,4 lb

Topplate
6,4 kg / 14,1 lb

Column counter
3 kg / 6,6 lb

Base
Ø50: 12,9 kg / 28,4 lb

TEST
EN 15372:2016, L2

CERTIFICATIONS
TSCA title VI compliant

PACKAGING TYPE
Brown box

PACKAGING MEASUREMENTS
(H × W × D)

Tabletop oak or linoleum 70 × 60
6 cm × 75 cm × 65 cm / 2,4" × 29,5" × 25,6"

Tabletop marble or stone 70 × 60
80 cm × 70 cm × 10 cm / 31,5" × 27,6" × 4"

Tabletop oak or linoleum Ø60
6 cm × 65 cm × 65 cm / 2,4" × 25,6" × 25,6"

Tabletop marble or stone Ø60
70 cm × 70 cm × 10 cm / 27,6" × 27,6" × 4"

Tabletop oak or linoleum Ø80
6 cm × 85 cm × 85 cm / 2,4" × 33,5" × 33,5"

Tabletop marble or stone Ø80
90 cm × 90 cm × 10 cm / 35,4" × 35,4" × 4"

Topplate Ø40
6 cm × 48 cm × 48 cm / 2,4" × 18,9" × 18,9"

Column counter (H × Ø)
105 cm × 7 cm / 41,3" × 2,8"

Base Ø50
6 cm × 58 cm × 58 cm / 2,4" × 22,8" × 22,8"

MATERIALS & MAINTENANCE
Please visit audocph.com for materials, care and maintenance instructions.

TECHNICAL SPECIFICATION

70 × 60

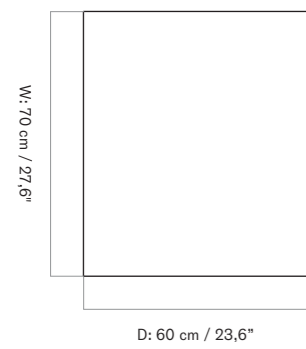

D: 60 cm / 23,6"

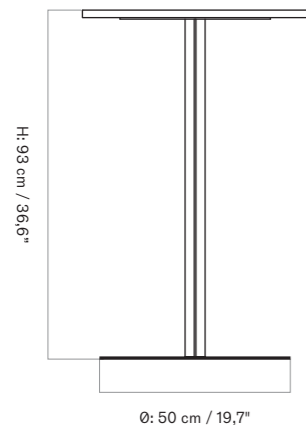

Ø: 50 cm / 19,7"

Ø60

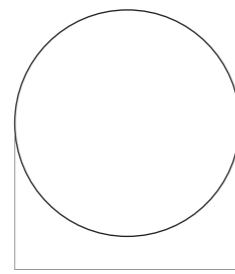

Ø: 60 cm / 23,6"

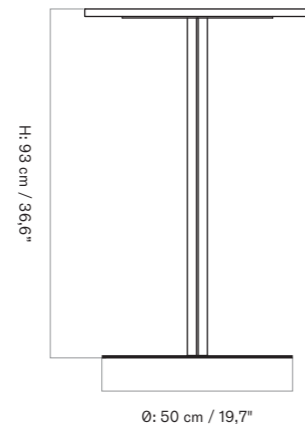

Ø: 50 cm / 19,7"

Ø80

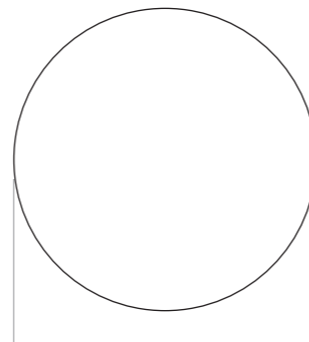

Ø: 80 cm / 31,5"

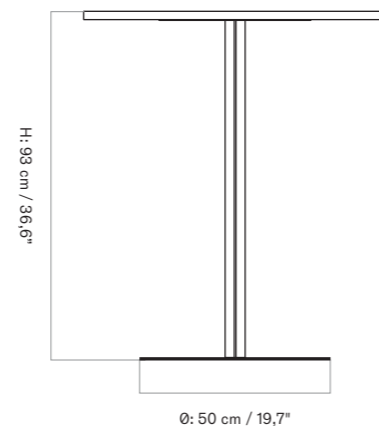

Ø: 50 cm / 19,7"



HARBOUR COLUMN COUNTER TABLE, STAR BASE
Designed by *Norm Architects*

Star-shaped, Black powder coated aluminium and steel base in with round or rectangular tabletop in Kunis breccia stone, Estremoz marble, Black painted oak or linoleum.



PRODUCT OPTIONS

Tabletop



BLACK PAINTED OAK

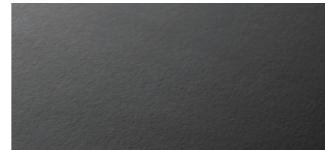

CHARCOAL LINOLEUM



ESTREMOZ MARBLE



KUNIS BRECCIA STONE

Base



BLACK POWDER COATED
ALUMINIUM & STEEL

PRODUCT TYPE
Counter and bar table

COLLI
1

Environment
Indoor

DIMENSIONS

70 x 60
H: 93 cm / 36,6"
W: 70 cm / 27,6"
D: 60 cm / 23,6"

Ø60
H: 93 cm / 36,6"
Ø: 60 cm / 23,6"

Ø80
H: 93 cm / 36,6"
Ø: 80 cm / 31,5"

PRODUCTION PROCESS

Star base is made of die casted aluminium and column is made of extruded aluminium. The top plate for mounting the tabletop to the base is made from flame cut steel. The tabletops are CNC milled. The tabletop in Kunis breccia stone and Estremoz marble is treated with a sealer.

Being composed of a natural material, each product is unique and the surface may nuance compared to the images.

COLOUR

Tabletop
Black (RAL 9005)
Charcoal (RAL 7012)
Off white (Estremoz marble)
Sand (Kunis breccia stone)

Base
Black (RAL 9005)

TECHNICAL SPECIFICATIONS

GLOSS
Gloss 10,20

MATERIALS

Tabletop
Kunis Ereccia stone, Estremoz marble, MDF and forbo linoleum or MDF and painted oak veneer

Topplate
Powder coated steel

Base
Cast, extruded aluminium, steel

WEIGHT

Tabletop oak or linoleum
Ø60: 8 kg / 17,6 lb
Ø80: 9 kg / 19,8 lb
70 x 60: 8,5 kg / 18,7 lb

Tabletop marble or stone
Ø60: 28 kg / 61,7 lb
Ø80: 52,8 kg / 116,4 lb
70 x 60: 36 kg / 79,4 lb

Topplate
6,4 kg / 14,1 lb

Column counter
2,5 kg / 5,5 lb

Star base
3,5 kg / 7,7 lb

TEST
EN 15372:2016, L2

CERTIFICATIONS
TSCA title VI compliant

PACKAGING TYPE
Brown box

PACKAGING MEASUREMENTS
(H x W x D)

Tabletop oak or linoleum 70 x 60
6 cm x 75 cm x 65 cm / 2,4" x 29,5" x 25,6"

Tabletop marble or stone 70 x 60
80 cm x 70 cm x 10 cm / 31,5" x 27,6" x 4"

Tabletop oak or linoleum Ø60
6 cm x 65 cm x 65 cm / 2,4" x 25,6" x 25,6"

Tabletop marble or stone Ø60
70 cm x 70 cm x 10 cm / 27,6" x 27,6" x 4"

Tabletop oak or linoleum Ø80
6 cm x 85 cm x 85 cm / 2,4" x 33,5" x 33,5"

Tabletop marble or stone Ø80
90 cm x 90 cm x 10 cm / 35,4" x 35,4" x 4"

Topplate
6 cm x 48 cm x 48 cm / 2,4" x 18,9" x 18,9"

Column counter (H x Ø)
75 cm x 7 cm / 29,5" x 2,8"

Star base
22 cm x 51 cm x 51 cm / 8,7" x 20,1" x 20,1"

MATERIALS & MAINTENANCE
Please visit audocph.com for materials, care and maintenance instructions.



HARBOUR COLUMN COUNTER TABLE, STAR BASE
Designed by *Norm Architects*

TECHNICAL SPECIFICATION

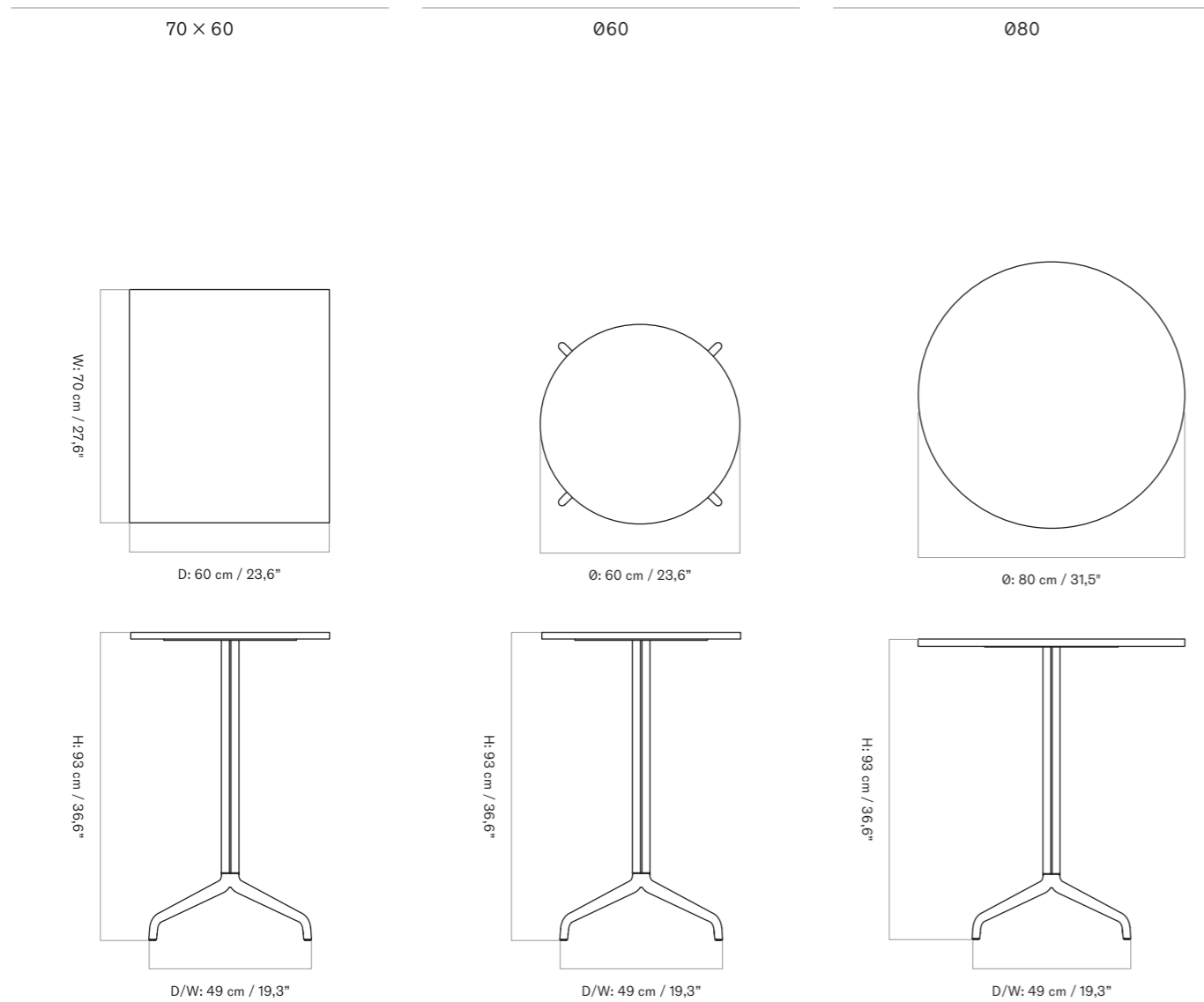

HARBOUR COLUMN BAR TABLE, STAR BASE, size 70x60,
material *Kunis Breccia stone*, designer *Norm Architects*
HARBOUR BAR STOOL, material *black steel / Dakar 0311*, designer *Norm Architects*

Black powder coated aluminium and steel base with round or rectangular tabletop in Kunis breccia stone, Estremoz marble, Black painted oak or linoleum.



PRODUCT OPTIONS

Tabletop

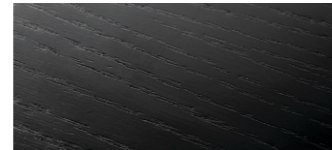

BLACK PAINTED OAK

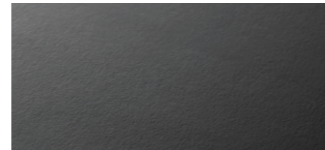

CHARCOAL LINOLEUM



ESTREMOZ MARBLE

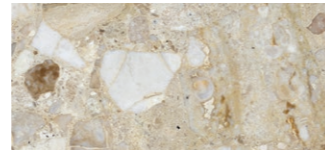

KUNIS BRECCIA STONE

Base



BLACK POWDER COATED
ALUMINIUM & STEEL

PRODUCT TYPE
Counter and bar table

COLLI
1

Environment
Indoor

DIMENSIONS

70 x 60
H: 103 cm / 40,6"
W: 70 cm / 27,6"
D: 60 cm / 23,6"

Ø60
H: 103 cm / 40,6"
Ø: 60 cm / 23,6"

Ø80
H: 103 cm / 40,6"
Ø: 80 cm / 31,5"

PRODUCTION PROCESS

Both base and top plate for mounting the tabletop to the base are made from flame-cut steel. The column is made of extruded aluminium. Tabletops are CNC milled and Kunis breccia stone and Estremoz marble versions are treated with a sealer.

Being composed of a natural material, each product is unique and the surface may nuance compared to the images.

COLOUR

Tabletop
Black (RAL 9005)
Charcoal (RAL 7012)
Off white (Estremoz marble)
Sand (Kunis breccia stone)

Base
Black (RAL 9005)

TECHNICAL SPECIFICATIONS

GLOSS
Gloss 10-20

MATERIALS

Tabletop
Kunis breccia stone, Estremoz marble, MDF and forbo linoleum or MDF and painted oak veneer

Topplate
Powder coated steel

Base
Cast, extruded aluminium, steel

WEIGHT

Tabletop oak or linoleum
Ø60: 8 kg / 17,6 lb
Ø80: 9 kg / 19,8 lb
70 x 60: 8,5 kg / 18,7 lb

Tabletop marble or stone
Ø60: 28 kg / 61,7 lb
Ø80: 52,8 kg / 116,4 lb
70 x 60: 36 kg / 79,4 lb

Topplate
6,4 kg / 14,1 lb

Column bar
3,3 kg / 7,3 lb

Base
Ø50: 12,9 kg / 28,4 lb

TEST
EN 15372:2016, L2

CERTIFICATIONS
TSCA title VI compliant

PACKAGING TYPE
Brown box

PACKAGING MEASUREMENTS
(H x W x D)

Tabletop oak or linoleum 70 x 60
6 cm x 75 cm x 65 cm / 2,4" x 29,5" x 25,6"

Tabletop marble or stone 70 x 60
80 cm x 70 cm x 10 cm / 31,5" x 27,6" x 4"

Tabletop oak or linoleum Ø60
6 cm x 65 cm x 65 cm / 2,4" x 25,6" x 25,6"

Tabletop marble or stone Ø60
70 cm x 70 cm x 10 cm / 27,6" x 27,6" x 4"

Tabletop oak or linoleum Ø80
6 cm x 85 cm x 85 cm / 2,4" x 33,5" x 33,5"

Tabletop marble or stone Ø80
90 cm x 90 cm x 10 cm / 35,4" x 35,4" x 4"

Topplate Ø40
6 cm x 48 cm x 48 cm / 2,4" x 18,9" x 18,9"

Column bar (H x Ø)
105 cm x 7 cm / 41,3" x 2,8"

Base Ø50
6 cm x 58 cm x 58 cm / 2,4" x 22,8" x 22,8"

MATERIALS & MAINTENANCE
Please visit audocph.com for materials, care and maintenance instructions.

TECHNICAL SPECIFICATION

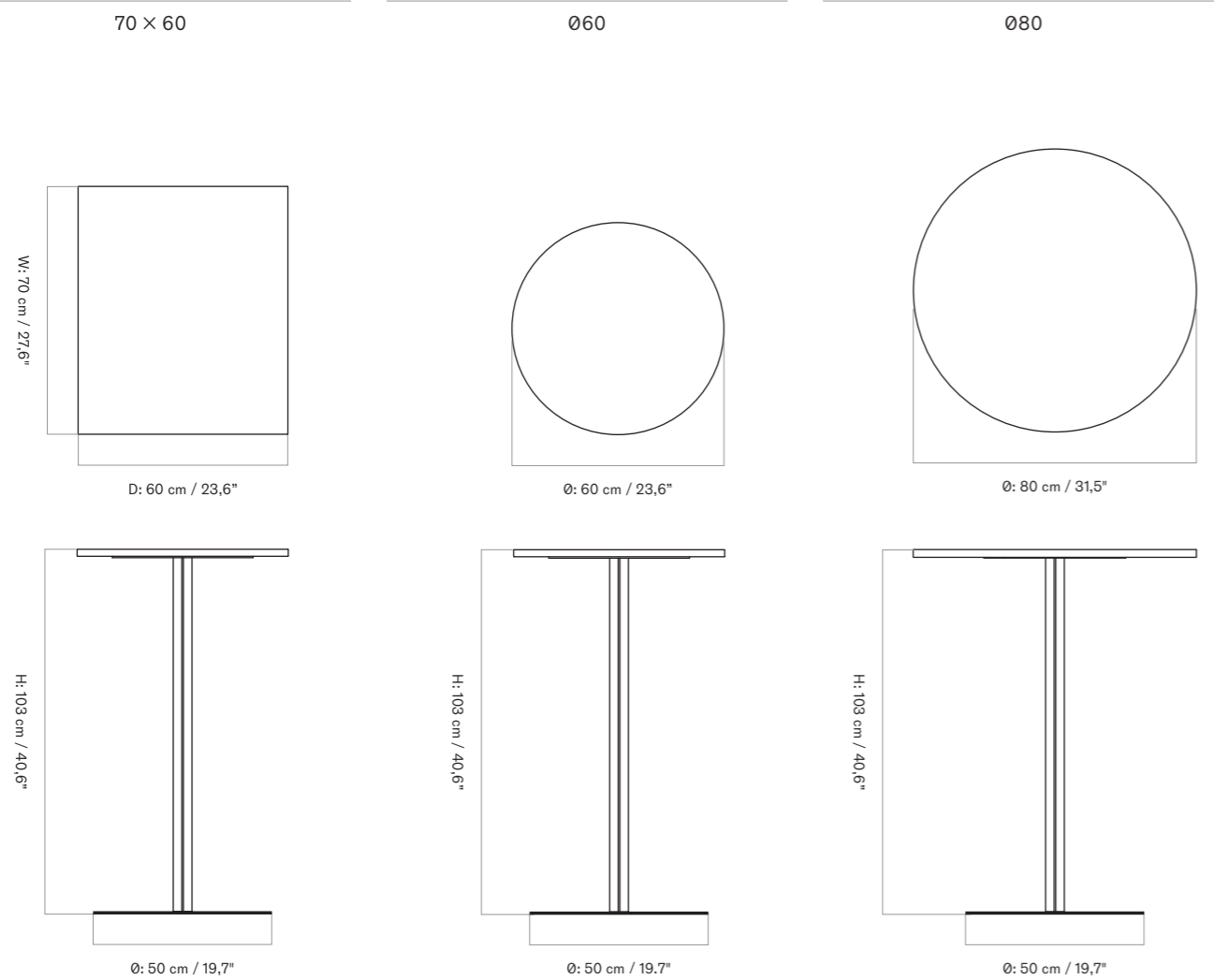

HARBOUR COLUMN DINING TABLE, CIRCULAR, size Ø80 cm, material *black steel / Kunis Breccia*, designer *Norm Architects*
READY DINING CHAIR VENEER, material *Red Stained Oak*, designer *Matias Mollenbach & Nick Rasmussen*



HARBOUR COLUMN BAR TABLE, STAR BASE
Designed by *Norm Architects*

Star-shaped, Black powder coated aluminium and steel base in with round or rectangular tabletop in Kunis breccia stone, Estremoz marble, Black painted oak or linoleum.



PRODUCT OPTIONS

Tabletop

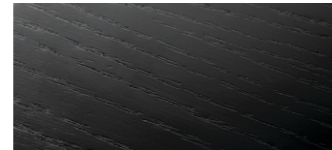

BLACK PAINTED OAK

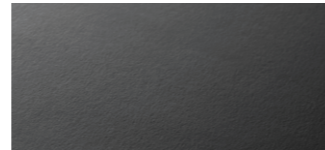

CHARCOAL LINOLEUM



ESTREMOZ MARBLE

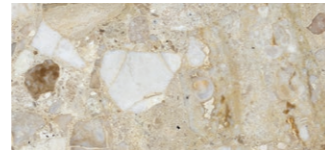

KUNIS BRECCIA STONE

Base



BLACK POWDER COATED
ALUMINIUM & STEEL

PRODUCT TYPE
Counter and bar table

COLLI
1

Environment
Indoor

DIMENSIONS

70 x 60
H: 103 cm / 40,6"
W: 70 cm / 27,6"
D: 60 cm / 23,6"

Ø60
H: 103 cm / 40,6"
Ø: 60 cm / 23,6"

Ø90
H: 103 cm / 40,6"
Ø: 80 cm / 31,5"

PRODUCTION PROCESS

Star base is made of die casted aluminium and column is made of extruded aluminium. The top plate for mounting the tabletop to the base is made from flame cut steel. The tabletops are CNC milled. The tabletop in Kunis breccia stone and Estremoz marble is treated with a sealer.

Being composed of a natural material, each product is unique and the surface may nuance compared to the images.

COLOUR

Tabletop
Black (RAL 9005)
Charcoal (RAL 7012)
Off white (Estremoz marble)
Sand (Kunis breccia stone)

Base
Black (RAL 9005)

TECHNICAL SPECIFICATIONS

GLOSS
Gloss 10,20

MATERIALS

Tabletop
Kunis Ereccia stone, Estremoz marble, MDF and forbo linoleum or MDF and painted oak veneer

Topplate
Powder coated steel

Base
Cast, extruded aluminium, steel

WEIGHT

Tabletop oak or linoleum
Ø60: 8 kg / 17,6 lb
Ø80: 9 kg / 19,8 lb
70 x 60: 8,5 kg / 18,7 lb

Tabletop marble or stone
Ø60: 28 kg / 61,7 lb
Ø80: 52,8 kg / 116,4 lb
70 x 60: 36 kg / 79,4 lb

Topplate
6,4 kg / 14,1 lb

Column bar
2,8 kg / 6,2 lb

Star base
3,5 kg / 7,7 lb

TEST
EN 15372:2016, L2

CERTIFICATIONS
TSCA title VI compliant

PACKAGING TYPE
Brown box

PACKAGING MEASUREMENTS
(H x W x D)

Tabletop oak or linoleum 70 x 60
6 cm x 75 cm x 65 cm / 2,4" x 29,5" x 25,6"

Tabletop marble or stone 70 x 60
80 cm x 70 cm x 10 cm / 31,5" x 27,6" x 4"

Tabletop oak or linoleum Ø60
6 cm x 65 cm x 65 cm / 2,4" x 25,6" x 25,6"

Tabletop marble or stone Ø60
70 cm x 70 cm x 10 cm / 27,6" x 27,6" x 4"

Tabletop oak or linoleum Ø80
6 cm x 85 cm x 85 cm / 2,4" x 33,5" x 33,5"

Tabletop marble or stone Ø80
90 cm x 90 cm x 10 cm / 35,4" x 35,4" x 4"

Topplate
6 cm x 48 cm x 48 cm / 2,4" x 18,9" x 18,9"

Column bar (H x Ø)
105 cm x 7 cm / 21,7" x 2,8"

Star base
22 cm x 51 cm x 51 cm / 8,7" x 20,1" x 20,1"

MATERIALS & MAINTENANCE
Please visit audocph.com for materials, care and maintenance instructions.



HARBOUR COLUMN BAR TABLE, STAR BASE
Designed by *Norm Architects*

TECHNICAL SPECIFICATION

70 × 60

Ø60

Ø80

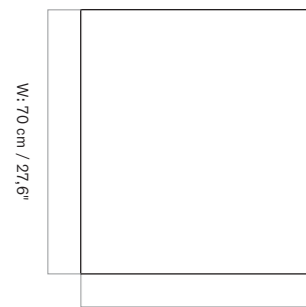

D: 60 cm / 23,6"

W: 70 cm / 27,6"

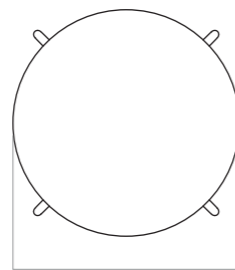

Ø: 60 cm / 23,6"

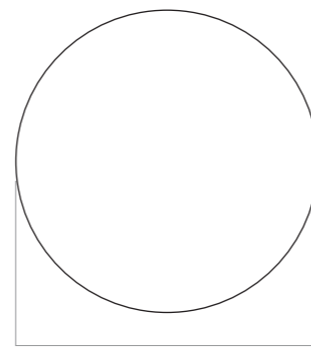

Ø: 80 cm / 31,5"

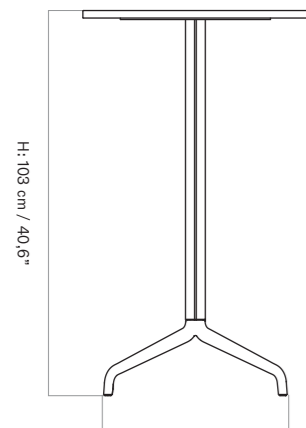

D/W: 49 cm / 19,3"

H: 103 cm / 40,6"

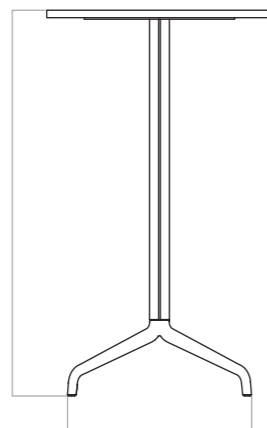

D/W: 49 cm / 19,3"

H: 103 cm / 40,6"

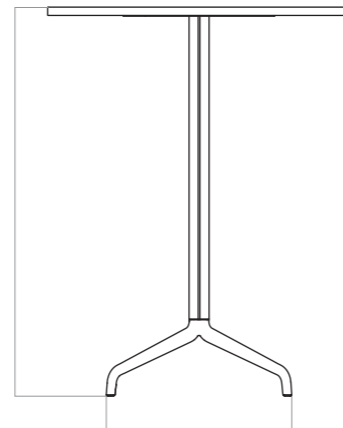

D/W: 49 cm / 19,3"

H: 103 cm / 40,6"