

Circuit Modular 3PC Armless Sofa



Himalaya
Cloud



Himalaya
Dune



Merino
Cream

The Circuit Modular Series is a contemporary seating collection that brings minimalist style to spaces large or small. Circuit's three sleek components—an armless chair, corner and ottoman—feature rounded profiles, with pleasing curves that invite relaxed entertaining and interaction. Rounded, solid natural ash legs complete the look by giving each piece an airy, floating quality perfect for small spaces. Combine the components to create a custom seating configuration that suits your home or work environment—Circuit's compact footprint is particularly well suited to lobbies, breakout rooms, hallways, and urban condominiums. Constructed with kiln-dried 100% FSC®-Certified hardwood in support of responsible forest management.

Design Trade Professionals: We aim to keep our designs in stock and ready to ship quickly for projects on a tight timeline. Designs may be customized with COM and alternate finishes (minimum quantities may apply). Visit gusmodern.com for more information about our Trade & Contract programs.

Circuit Modular 3PC Armless Sofa

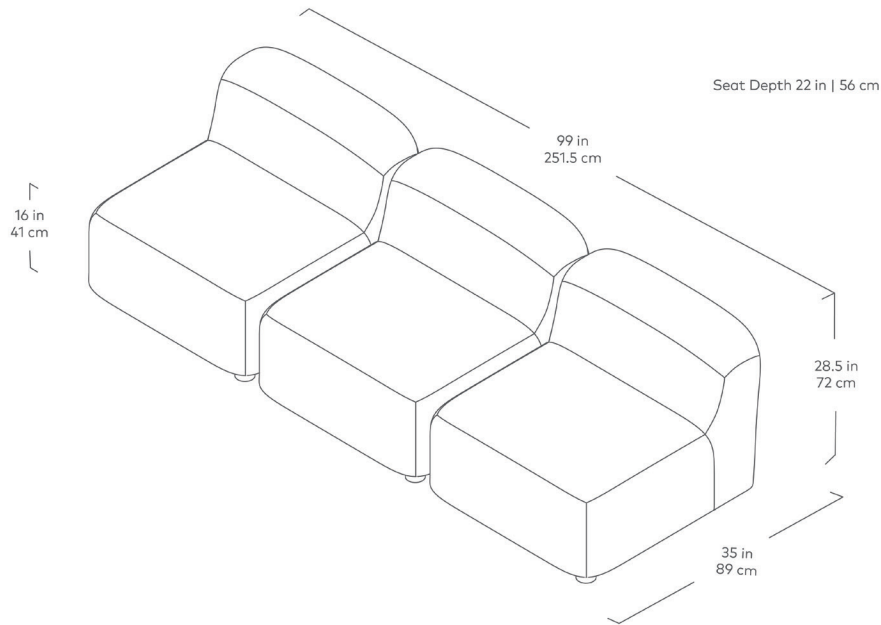

- Circuit Modular Series utilizes 3 different modular components - Armless, Corner & Ottoman.
- All modular components can be joined using integrated, concealed connectors on underside to securely join them to each other while in sectional, sofa or chaise formation.
- Tight seat and back.
- Upholstered with high resilience polyurethane foam covered in a Dacron wrap.
- Frame is kiln-dried 100% FSC®-Certified hardwood (FSC® 092551).
- Cylindrical, solid FSC® Certified ash legs are finished in a water-based, clear coat finish.
- Plastic bumpers on all legs to prevent floor damage.
- All joints have been stress tested.
- 9 gauge No-Sag, injection-molded sinuous spring clip system.
- Manufactured to meet California TB117-2013 fire safety standards without the use of flame retardant additives in the upholstery foam.

