

Drip HW58-HW64 & HW111-HW114

Hee Welling

2021



Drip^{HW58} Hee Welling 2021



Product category

Table

Environment

Indoor

Material

Aluminium base, MDF table top with Fenix Nano laminate, Forbo linoleum or wood veneer with matching colour high gloss edge bands for laminate & linoleum and matching edge bands for wood veneer.

Production process

The frame is made from extruded, powder coated aluminium. The table top is made from MDF covered with veneer, linoleum or laminate

Dimensions

H: 74cm/29.6in, W: 80cm/32in, D: 140cm/56in
Custom sizes are available with 6-8 weeks lead time

Package dimensions

Table top: H: 7cm/2.8in, W: 84cm/33.5in, D: 144cm/57.6in
Table frame: H: 8cm/3.2in, W: 234cm/93.6in, D: 26cm/10.4in

Colli quantity

1 pc

Weight

Product: 25 kg
Table top incl. packaging: 16.9kg
Table frame incl. packaging: 12.3kg

Gliders

Plastic gliders are installed as standard.
Castors available upon request (6-8 weeks lead time).

Table top finishes

Nero Ingo Fenix Nano Laminate (0720)
Bianco Male Fenix Nano Laminate (0029)

Made to order (6-8 weeks lead time):

Linoleum - all colours
Nano Laminate - all colours
Veneer - oak or walnut

Base finishes

Black, Bronzed

Strength, Durability and Safety Testing

The table is tested for strength, durability and safety according to: - EN 16139 Level 2 - Extreme use.

Cleaning Instructions

Please download our Material Care & Cleaning Instructions through www.andtradition.com

→ Stock items

Nero Ingo Fenix Nano Laminate (0720) or Bianco Male Fenix Nano Laminate (0029) with Black or Bronzed base.



→ Black /
Nero Ingo
Fenix Nano
Laminate



→ Black /
Bianco Male
Fenix Nano
Laminate



→ Bronzed /
Nero Ingo
Fenix Nano
Laminate



→ Bronzed /
Bianco Male
Fenix Nano
Laminate

Related products

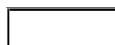

HW59

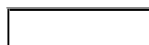

HW60

&Tradition®

Drip^{HW59} Hee Welling 2021

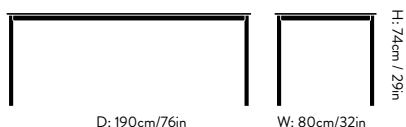

Product category

Table

Environment

Indoor

Material

Aluminium base, MDF table top with Fenix Nano laminate, Forbo linoleum or wood veneer with matching colour high gloss edge bands for laminate & linoleum and matching edge bands for wood veneer.

Production process

The frame is made from extruded, powder coated aluminium. The table top is made from MDF covered with veneer, linoleum or laminate

Dimensions

H: 74cm/29.6in, W: 80cm/32in, D: 190cm/76in
Custom sizes are available with 6-8 weeks lead time

Package dimensions

Table top: H: 7cm/2.8in, W: 84cm/33.5in,
D: 194cm/77.6in
Table frame: H: 8cm/3.2in, W: 234cm/93.6in,
D: 26cm/10.4in

Colli quantity

1 pc

Weight

Product: 32.2 kg
Table top incl. packaging: 23.2kg
Table frame incl. packaging: 13.7kg

Gliders

Plastic gliders are installed as standard.
Castors available upon request (6-8 weeks lead time).

Table top finishes

Nero Ingo Fenix Nano Laminate (0720)
Bianco Male Fenix Nano Laminate (0029)

Made to order (6-8 weeks lead time):

Linoleum - all colours
Nano Laminate - all colours
Veneer - oak or walnut

Base finishes

Black, Bronzed

Strength, Durability and Safety Testing

The table is tested for strength, durability and safety according to: - EN 16139 Level 2 - Extreme use.

Cleaning Instructions

Please download our Material Care & Cleaning Instructions through www.andtradition.com

→ Stock items

Nero Ingo Fenix Nano Laminate (0720) or Bianco Male Fenix Nano Laminate (0029) with Black or Bronzed base.



→ Black /
Nero Ingo
Fenix Nano
Laminate



→ Black /
Bianco Male
Fenix Nano
Laminate



→ Bronzed /
Nero Ingo
Fenix Nano
Laminate



→ Bronzed /
Bianco Male
Fenix Nano
Laminate

Related products



HW58



HW60

&Tradition®

Drip^{HW60} Hee Welling 2021

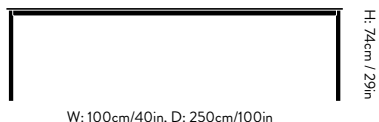

Product category

Table

Environment

Indoor

Material

Aluminium base, MDF table top with Fenix Nano laminate, Forbo linoleum or wood veneer with matching colour high gloss edge bands for laminate & linoleum and matching edge bands for wood veneer.

Production process

The frame is made from extruded, powder coated aluminium. The table top is made from MDF covered with veneer, linoleum or laminate

Dimensions

H: 74cm/29.6in, W: 100cm/40in, D: 250cm/100in

Custom sizes are available with 6-8 weeks lead time

Package dimensions

Table top: H: 7cm/2.8in, W: 104cm/41.6in, D: 254cm/101.6in

Table frame: H: 8cm/3.2in, W: 258cm/103.2in, D: 26cm/10.4in

Colli quantity

1 pc

Weight

Product: 49kg,

Table top incl. packaging: 39.4kg

Table frame incl. packaging: 16kg

Gliders

Plastic gliders are installed as standard.

Castors available upon request (6-8 weeks lead time).

Table top finishes

Nero Ingo Fenix Nano Laminate (0720)

Bianco Male Fenix Nano Laminate (0029)

Made to order (6-8 weeks lead time):

Linoleum - all colours

Nano Laminate - all colours

Veneer - oak or walnut

Base finishes

Black, Bronzed

Strength, Durability and Safety Testing

The table is tested for strength, durability and safety according to: - EN 16139 Level 2 - Extreme use.

Cleaning Instructions

Please download our Material Care & Cleaning Instructions through www.andtradition.com

→ Stock items

Nero Ingo Fenix Nano Laminate (0720) or Bianco Male Fenix Nano Laminate (0029) with Black or Bronzed base.



→ Black /
Nero Ingo
Fenix Nano
Laminate



→ Black /
Bianco Male
Fenix Nano
Laminate



→ Bronzed /
Nero Ingo
Fenix Nano
Laminate



→ Bronzed /
Bianco Male
Fenix Nano
Laminate

Related products



HW58

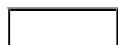

HW59

&Tradition®

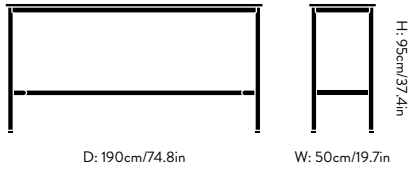

Drip^{HW61} Hee Welling 2021

Product category
Counter table

Environment
Indoor

Material
Aluminium base, MDF table top with Fenix Nano laminate, Forbo linoleum or wood veneer with matching colour high gloss edge bands for laminate & linoleum and matching edge bands for wood veneer.

Production process
The frame is made from extruded, powder coated aluminium. The table top is made from MDF covered with veneer, linoleum or laminate.

Dimensions
H: 95cm/37.4in, W: 50cm/19.7, D: 190cm/74.8in

Package dimensions
Table top: H: 7cm/2.8in, W: 54cm/21.3in,
D: 194cm/76.4in
Table frame: H: 16cm/6.3in, W: 184cm/72.4in,
D: 27cm/10.6in

Colli quantity
1 pc

Weight
Product: 27.8kg,
Table top incl. packaging: 13.9kg,
Table frame incl. packaging: 19.9kg

Gliders
Plastic gliders are installed as standard.
Castors available upon request (6-8 weeks lead time).

Table top finishes
Nero Ingo Fenix Nano Laminate (0720)
Bianco Male Fenix Nano Laminate (0029)

Made to order (6-8 weeks lead time):
Linoleum - all colours
Nano Laminate - all colours
Veneer - oak or walnut

Base finishes
Black, Bronzed

Strength, Durability and Safety Testing
The table is tested for strength, durability and safety according to: - EN 16139 Level 2 - Extreme use.

Cleaning Instructions
Please download our Material Care & Cleaning Instructions through www.andtradition.com

→ **Stock items**
Nero Ingo Fenix Nano Laminate (0720) or Bianco Male Fenix Nano Laminate (0029) with Black or Bronzed base.



→ Black /
Nero Ingo
Fenix Nano
Laminate

→ Black /
Bianco Male
Fenix Nano
Laminate

→ Bronzed /
Nero Ingo
Fenix Nano
Laminate

→ Bronzed /
Bianco Male
Fenix Nano
Laminate

Related products



HW58

HW60

&Tradition®

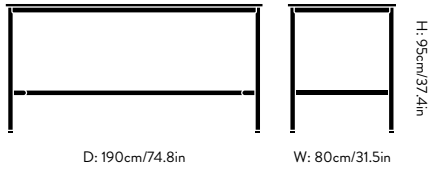

Drip^{HW62} Hee Welling 2021

Product category

Counter table

Environment

Indoor

Material

Aluminium base, MDF table top with Fenix Nano laminate, Forbo linoleum or wood veneer with matching colour high gloss edge bands for laminate & linoleum and matching edge bands for wood veneer.

Production process

The frame is made from extruded, powder coated aluminium. The table top is made from MDF covered with veneer, linoleum or laminate.

Dimensions

H: 95cm/37.4in, W: 80cm/31.5, D: 190cm/74.8in

Package dimensions

Table top: H: 7cm/2.8in, W: 84cm/33.1in,

D: 194cm/76.4in

Table frame: H: 16cm/6.3in, W: 184cm/72.4in,

D: 27cm/10.6in

Colli quantity

1 pc

Weight

Product: 37.6kg,

Table top incl. packaging: 23.2kg,

Table frame incl. packaging: 21.7kg

Gliders

Plastic gliders are installed as standard.

Castors available upon request (6-8 weeks lead time).

Table top finishes

Nero Ingo Fenix Nano Laminate (0720)

Bianco Male Fenix Nano Laminate (0029)

Made to order (6-8 weeks lead time):

Linoleum - all colours

Nano Laminate - all colours

Veneer - oak or walnut

Base finishes

Black, Bronzed

Strength, Durability and Safety Testing

The table is tested for strength, durability and safety according to: - EN 16139 Level 2 - Extreme use.

Cleaning Instructions

Please download our Material Care & Cleaning Instructions through www.andtradition.com

→ Stock items

Nero Ingo Fenix Nano Laminate (0720) or Bianco Male Fenix Nano Laminate (0029) with Black or Bronzed base.



→ Black /
Nero Ingo
Fenix Nano
Laminate



→ Black /
Bianco Male
Fenix Nano
Laminate



→ Bronzed /
Nero Ingo
Fenix Nano
Laminate



→ Bronzed /
Bianco Male
Fenix Nano
Laminate

Related products



HW58

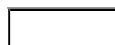

HW59

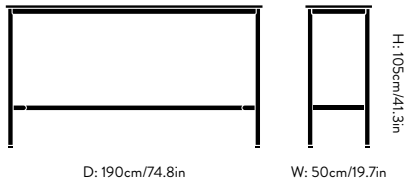

Drip^{HW63} Hee Welling 2021

Product category

Bar table

Environment

Indoor

Material

Aluminium base, MDF table top with Fenix Nano laminate, Forbo linoleum or wood veneer with matching colour high gloss edge bands for laminate & linoleum and matching edge bands for wood veneer.

Production process

The frame is made from extruded, powder coated aluminium. The table top is made from MDF covered with veneer, linoleum or laminate.

Dimensions

H: 105cm/41.3in, W: 50cm/19.7, D: 190cm/74.8in

Package dimensions

Table top: H: 7cm/2.8in, W: 54cm/21.3in,

D: 194cm/76.4in

Table frame: H: 16cm/6.3in, W: 184cm/72.4in,

D: 27cm/10.6in

Colli quantity

1 pc

Weight

Product: 26.8kg,

Table top incl. packaging: 13.9kg,

Table frame incl. packaging: 20.2kg

Gliders

Plastic gliders are installed as standard.

Castors available upon request (6-8 weeks lead time).

Table top finishes

Nero Ingo Fenix Nano Laminate (0720)

Bianco Male Fenix Nano Laminate (0029)

Made to order (6-8 weeks lead time):

Linoleum - all colours

Nano Laminate - all colours

Veneer - oak or walnut

Base finishes

Black, Bronzed

Strength, Durability and Safety Testing

The table is tested for strength, durability and safety according to: - EN 16139 Level 2 - Extreme use.

Cleaning Instructions

Please download our Material Care & Cleaning Instructions through www.andtradition.com

→ Stock items

Nero Ingo Fenix Nano Laminate (0720) or Bianco Male Fenix Nano Laminate (0029) with Black or Bronzed base.



→ Black /
Nero Ingo
Fenix Nano
Laminate



→ Black /
Bianco Male
Fenix Nano
Laminate



→ Bronzed /
Nero Ingo
Fenix Nano
Laminate



→ Bronzed /
Bianco Male
Fenix Nano
Laminate

Related products



HW58



HW59

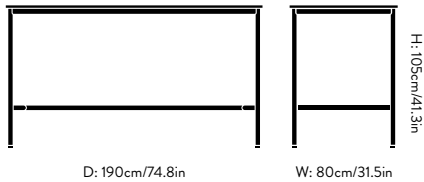

Drip^{HW64} Hee Welling 2021

Product category

Bar table

Environment

Indoor

Material

Aluminium base, MDF table top with Fenix Nano laminate, Forbo linoleum or wood veneer with matching colour high gloss edge bands for laminate & linoleum and matching edge bands for wood veneer.

Production process

The frame is made from extruded, powder coated aluminium. The table top is made from MDF covered with veneer, linoleum or laminate.

Dimensions

H: 105cm/41.3in, W: 80cm/31.5, D: 190cm/74.8in

Package dimensions

Table top: H: 7cm/2.8in, W: 84cm/33.1in,

D: 194cm/76.4in

Table frame: H: 16cm/6.3in, W: 184cm/72.4in,

D: 27cm/10.6in

Colli quantity

1 pc

Weight

Product: 37.9kg,

Table top incl. packaging: 23.2kg,

Table fram incl. packaging: 22kg

Gliders

Plastic gliders are installed as standard.

Castors available upon request (6-8 weeks lead time).

Table top finishes

Nero Ingo Fenix Nano Laminate (0720)

Bianco Male Fenix Nano Laminate (0029)

Made to order (6-8 weeks lead time):

Linoleum - all colours

Nano Laminate - all colours

Veneer - oak or walnut

Base finishes

Black, Bronzed

Strength, Durability and Safety Testing

The table is tested for strength, durability and safety according to: - EN 16139 Level 2 - Extreme use.

Cleaning Instructions

Please download our Material Care & Cleaning Instructions through www.andtradition.com

→ Stock items

Nero Ingo Fenix Nano Laminate (0720) or Bianco Male Fenix Nano Laminate (0029) with Black or Bronzed base.



→ Black /
Nero Ingo
Fenix Nano
Laminate



→ Black /
Bianco Male
Fenix Nano
Laminate



→ Bronzed /
Nero Ingo
Fenix Nano
Laminate



→ Bronzed /
Bianco Male
Fenix Nano
Laminate

Related products



HW58

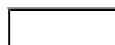

HW59

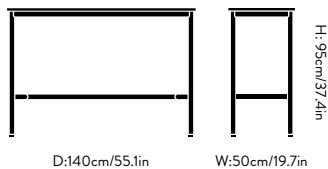

Drip^{HW111} Hee Welling 2021

Product category

Counter table

Environment

Indoor

Material

Aluminium base, MDF table top with Fenix Nano laminate, Forbo linoleum or wood veneer with matching colour high gloss edge bands for laminate & linoleum and matching edge bands for wood veneer.

Production process

The frame is made from extruded, powder coated aluminium. The table top is made from MDF covered with veneer, linoleum or laminate.

Dimensions

H: 95cm/37.4in, W: 50cm/19.7, D:140cm/55.1in

Package dimensions

Table top: H: 7cm/2.8in, W: 54cm/21.3in,

D: 144cm/56.7in

Table frame: H: 16cm/6.3in, W: 184cm/72.4in,

D: 27cm/10.6in

Colli quantity

1 pc

Weight

Product: 22.9kg,

Table top incl. packaging: 10.3kg,

Table frame incl. packaging: 17.8kg

Gliders

Plastic gliders are installed as standard.

Castors available upon request (6-8 weeks lead time).

Table top finishes

Nero Ingo Fenix Nano Laminate (0720)

Bianco Male Fenix Nano Laminate (0029)

Made to order (6-8 weeks lead time):

Linoleum - all colours

Nano Laminate - all colours

Veneer - oak or walnut

Base finishes

Black, Bronzed

Strength, Durability and Safety Testing

The table is tested for strength, durability and safety according to: - EN 16139 Level 2 - Extreme use.

Cleaning Instructions

Please download our Material Care & Cleaning Instructions through www.andtradition.com

→ Stock items

Nero Ingo Fenix Nano Laminate (0720) or Bianco Male Fenix Nano Laminate (0029) with Black or Bronzed base.



→ Black /
Nero Ingo
Fenix Nano
Laminate



→ Black /
Bianco Male
Fenix Nano
Laminate



→ Bronzed /
Nero Ingo
Fenix Nano
Laminate



→ Bronzed /
Bianco Male
Fenix Nano
Laminate

Related products

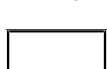

HW58



HW113

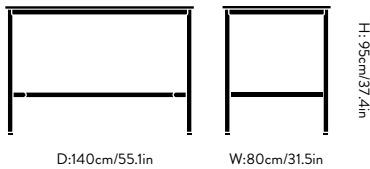

Drip^{HW112} Hee Welling 2021

Product category

Counter table

Environment

Indoor

Material

Aluminium base, MDF table top with Fenix Nano laminate, Forbo linoleum or wood veneer with matching colour high gloss edge bands for laminate & linoleum and matching edge bands for wood veneer.

Production process

The frame is made from extruded, powder coated aluminium. The table top is made from MDF covered with veneer, linoleum or laminate.

Dimensions

H: 95cm/37.4in, W: 80cm/31.5, D:140cm/55.12in

Package dimensions

Table top: H: 7cm/2.8in, W: 84cm/33.1in,

D: 144cm/56.7in

Table frame: H: 16cm/6.3in, W: 184cm/72.4in,

D: 27cm/10.6in

Colli quantity

1 pc

Weight

Product: 30.2kg,

Table top incl. packaging: 16.9kg,

Table frame incl. packaging: 19.8kg

Gliders

Plastic gliders are installed as standard.

Castors available upon request (6-8 weeks lead time).

Table top finishes

Nero Ingo Fenix Nano Laminate (0720)

Bianco Male Fenix Nano Laminate (0029)

Made to order (6-8 weeks lead time):

Linoleum - all colours

Nano Laminate - all colours

Veneer - oak or walnut

Base finishes

Black, Bronzed

Strength, Durability and Safety Testing

The table is tested for strength, durability and safety according to: - EN 16139 Level 2 - Extreme use.

Cleaning Instructions

Please download our Material Care & Cleaning Instructions through www.andtradition.com

→ Stock items

Nero Ingo Fenix Nano Laminate (0720) or Bianco Male Fenix Nano Laminate (0029) with Black or Bronzed base.



→ Black /
Nero Ingo
Fenix Nano
Laminate



→ Black /
Bianco Male
Fenix Nano
Laminate



→ Bronzed /
Nero Ingo
Fenix Nano
Laminate



→ Bronzed /
Bianco Male
Fenix Nano
Laminate

Related products



HW58

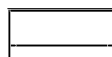

HW61

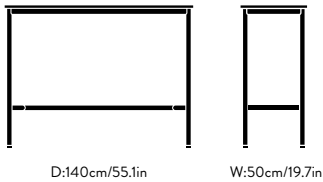

Drip^{HW113} Hee Welling 2021

Product category

Bar table

Environment

Indoor

Material

Aluminium base, MDF table top with Fenix Nano laminate, Forbo linoleum or wood veneer with matching colour high gloss edge bands for laminate & linoleum and matching edge bands for wood veneer.

Production process

The frame is made from extruded, powder coated aluminium. The table top is made from MDF covered with veneer, linoleum or laminate.

Dimensions

H: 105cm/41.3in, W: 50cm/19.7, D:140cm/55.1in

Package dimensions

Table top: H: 7cm/2.8in, W: 54cm/21.3in,

D: 144cm/56.7in

Table frame: H: 16cm/6.3in, W: 184cm/72.4in,

D: 27cm/10.6in

Colli quantity

1 pc

Weight

Product: 23.4kg,

Table top incl. packaging: 10.3kg,

Table frame incl. packaging: 18.3kg

Gliders

Plastic gliders are installed as standard.

Castors available upon request (6-8 weeks lead time).

Table top finishes

Nero Ingo Fenix Nano Laminate (0720)

Bianco Male Fenix Nano Laminate (0029)

Made to order (6-8 weeks lead time):

Linoleum - all colours

Nano Laminate - all colours

Veneer - oak or walnut

Base finishes

Black, Bronzed

Strength, Durability and Safety Testing

The table is tested for strength, durability and safety according to: - EN 16139 Level 2 - Extreme use.

Cleaning Instructions

Please download our Material Care & Cleaning Instructions through www.andtradition.com

→ Stock items

Nero Ingo Fenix Nano Laminate (0720) or Bianco Male Fenix Nano Laminate (0029) with Black or Bronzed base.



→ Black /
Nero Ingo
Fenix Nano
Laminate



→ Black /
Bianco Male
Fenix Nano
Laminate



→ Bronzed /
Nero Ingo
Fenix Nano
Laminate



→ Bronzed /
Bianco Male
Fenix Nano
Laminate

Related products



HW58

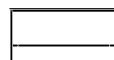

HW61

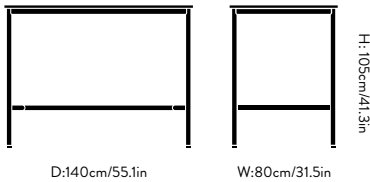

Drip^{HW114} Hee Welling 2021

Product category

Bar table

Environment

Indoor

Material

Aluminium base, MDF table top with Fenix Nano laminate, Forbo linoleum or wood veneer with matching colour high gloss edge bands for laminate & linoleum and matching edge bands for wood veneer.

Production process

The frame is made from extruded, powder coated aluminium. The table top is made from MDF covered with veneer, linoleum or laminate.

Dimensions

H: 105cm/41.3in, W: 80cm/31.5, D: 140cm/55.1in

Package dimensions

Table top: H: 7cm/2.8in, W: 84cm/33.1in,

D: 144cm/56.7in

Table frame: H: 16cm/6.3in, W: 184cm/72.4in,

D: 27cm/10.6in

Colli quantity

1 pc

Weight

Product: 30.3kg,

Table top incl. packaging: 16.9kg,

Table frame incl. packaging: 19.9kg

Gliders

Plastic gliders are installed as standard.

Castors available upon request (6-8 weeks lead time).

Table top finishes

Nero Ingo Fenix Nano Laminate (0720)

Bianco Male Fenix Nano Laminate (0029)

Made to order (6-8 weeks lead time):

Linoleum - all colours

Nano Laminate - all colours

Veneer - oak or walnut

Base finishes

Black, Bronzed

Strength, Durability and Safety Testing

The table is tested for strength, durability and safety according to: - EN 16139 Level 2 - Extreme use.

Cleaning Instructions

Please download our Material Care & Cleaning Instructions through www.andtradition.com

→ Stock items

Nero Ingo Fenix Nano Laminate (0720) or Bianco Male Fenix Nano Laminate (0029) with Black or Bronzed base.



→ Black /
Nero Ingo
Fenix Nano
Laminate



→ Black /
Bianco Male
Fenix Nano
Laminate



→ Bronzed /
Nero Ingo
Fenix Nano
Laminate



→ Bronzed /
Bianco Male
Fenix Nano
Laminate

Related products



HW58

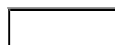

HW59

User instructions



Drip HW58-HW60

Hee Welling

2021

Congratulations with your new Drip table, designed in 2021 by Hee Welling. We hope you will enjoy using this product and follow these instructions to ensure correct assembly. If you have any questions or comments, please do not hesitate to contact us by mail on:

info@andtradition.com

Drip HW58-HW60

Hee Welling

2021

Please read these instructions carefully and retain them for future reference to ensure that the product is used correctly. For your own safety, please study each step of this instruction manual first. &Tradition is not responsible for any faults or damages caused by not following these instructions correctly. Do not modify this product in any way.

Contents

- A Tabletop
- B Legs x 4
- C Corners x 4
- D Long frames x 2
- E Short frames x 2
- F Flat head hex screws x 16
- G Short button screws x 16
- H Long button screws x 8
- I Allen key
- J Cover component x 4

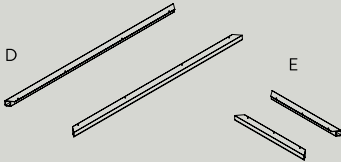
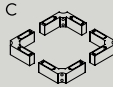
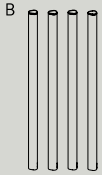
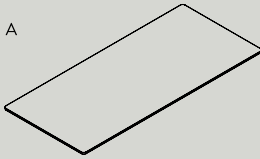

Safety precautions

- Dispose of plastic bag from packaging and do not allow children to play with it.
- The table is only intended for indoor use.
- Handle tabletop with care in order not to scratch surfaces.
- Two or more adults are required when lifting the table.

Cleaning instructions

Laminate can be cleaned with a soft cloth wrung in a mild solution of lukewarm water and an universal cleaning detergent. Always wipe with a dry soft cloth after cleaning. For difficult stains such as coffee or tea use a nylon bristle brush with mild household cleaner or detergent, rinsing with clean water and repeating as necessary. Rinse thoroughly with water.

Aluminium (powder coated or polished) can be cleaned using a soft cloth wrung in lukewarm water. Always dry immediately with a soft cloth. Avoid use of abrasive cleaning products such as steel wool as this will cause damage to the surface.

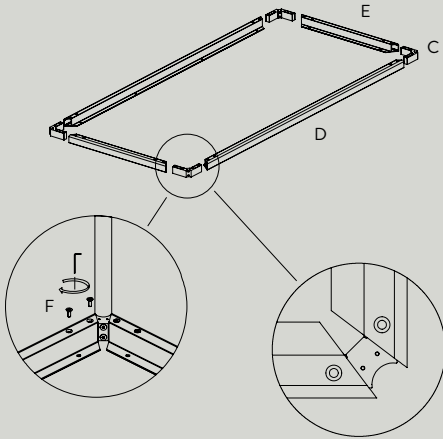

NB! Make sure the holes on the corner (C) are facing up.

Step 1

Insert the corners (C) into the frames (D & E) as shown and attach them with screw (F). The 2 small holes on the corners (C) must be facing upwards, see illustration.

Important: Install only the screws slightly and then finally tighten all of them.

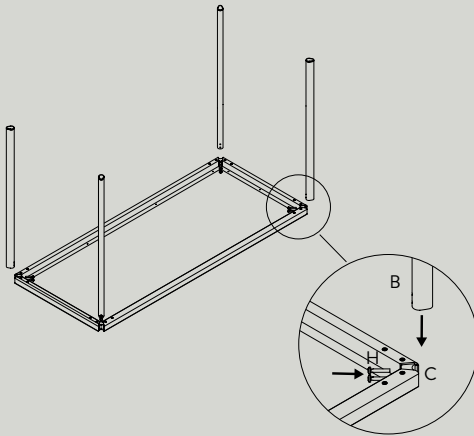

Step 2

Place the leg-section on the frame upside down and align all four legs in each corner (C). Install two long button screws (H) in each corner to connect them.

Step 3

Place the cover components (J) on each of the 4 corners

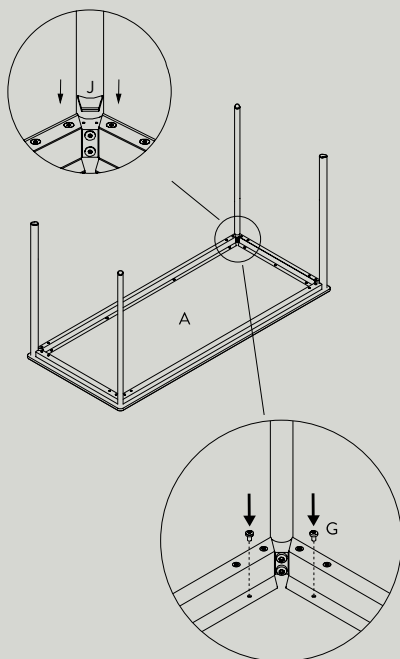

Step 4

Place the tabletop (A) upside down on a soft, flat surface and place the frame on top, upside down.

Important: Install only the screws (G) slightly and then finally tighten all of them to secure correct fit.

Finally, flip the table and enjoy your product.