

AJ MINI ANNIVERSARY EDITION

The fixture emits downward directed light. The angle of the shade can be adjusted to optimize light distribution. The shade is painted pale rose on the inside to ensure a soft comfortable light.

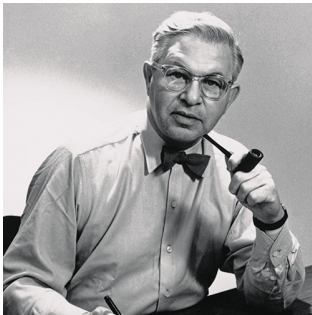

Arne Jacobsen

Arne Jacobsen was born and raised in Copenhagen. In 1927, he graduated as an architect from the Royal Danish Academy of Fine Arts in Copenhagen. After graduating, he obtained his first job at the office of the City Architect of Copenhagen launching his own office only two years later.



Product info

Information

Please note that the brass surface is untreated. This means that the surface will change over time and develop a patina.

Mounting

Cord: 2,4 m. White fabric with plug. Switch: On the lamp base.

Finish

White wet painted outside and pale rose powder coated inner side. Polished brass, untreated.

Materials

Shade: Spun steel. Injection moulded zinc base. Stem: Polished brass. Switch: Polished brass on lamp base.

Sizes and weights

Width x Height x Length (mm) | 113 x 433 x 183 Max 1.3 kg

Class

Ingress protection IP20. Electric shock protection II.

Light source

1x20W E14

Information

Please note that the brass surface is untreated. This means that the surface will change over time and develop a patina.



Related products



AJ Mini Table



AJ Royal



AJ Table



AJ Wall Lamp



AJ Floor



AJ 50 Wall



AJ Garden Bollard



AJ Oxford Table Lamp

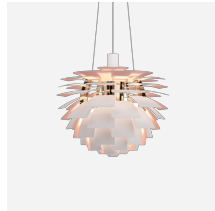

PH Artichoke Anniversary Edition



PH 5 Anniversary Edition

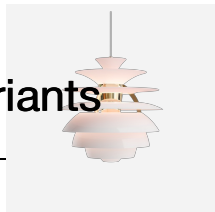

PH Snowball Anniversary Edition

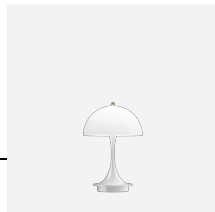

Panthella 160 Portable Anniversary Edition

Product variants

Light source
1x20W E14

Design

Arne Jacobsen

Weight

1.307

Finish

Matte white/pale rose

Light distribution diagrams

Cartesian

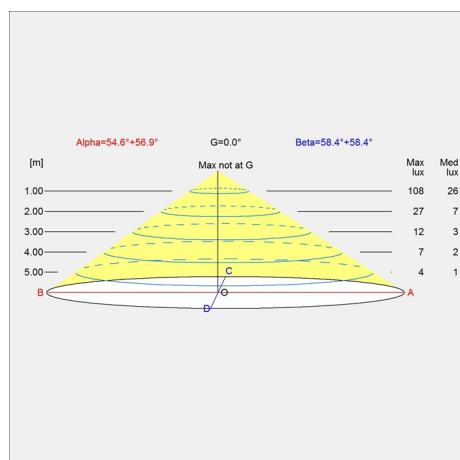

Isolux

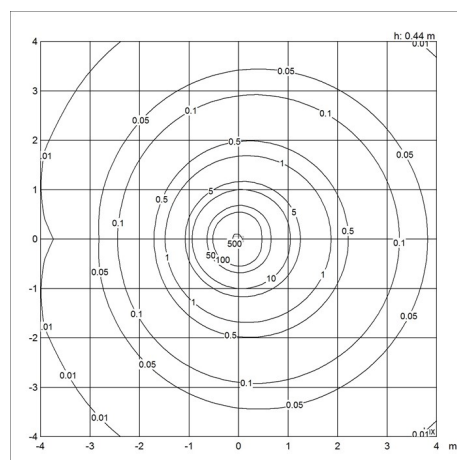

Polar

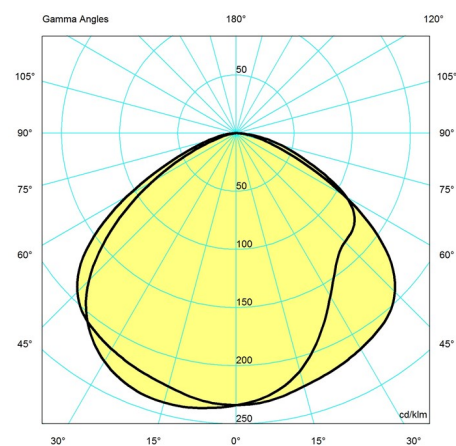

Spare parts & accessories

Product

AJ Brass union nut
AJ Lacquered Brass union nut

Variant number

5744170563
5744170576