

1967 Pendant, US

Designed by Paavo Tynell



ITEM NUMBER

1967 Pendant, US - Base: Brass, Shade:Canvas

10119349

DESCRIPTION

Known to many as 'the man who illuminated Finland', the legendary designer and metalsmith Paavo Tynell is one of the leading lights of 20th-century industrial design. A classic 1950s Tynell design, the 1967 pendant expands on the design language developed in 1948 for the 1965 pendant. The 1967 is characterized by a conical canvas shade which exudes warm ambient light, with Tynell's signature brass hardware adding a subtle, premium expression. Below the bulb, a fabric diffuser modulates the light and, beneath this, a decorative brass detail gives each lamp a flourish of character, and subtly influences the play of light it generates.

Materials & Finishes

SHADE FINISH

Canvas



CANOPY FINISH

Brass, Polished



CORD SHAPE	Round
CORD COLOR	Golden

Dimensions

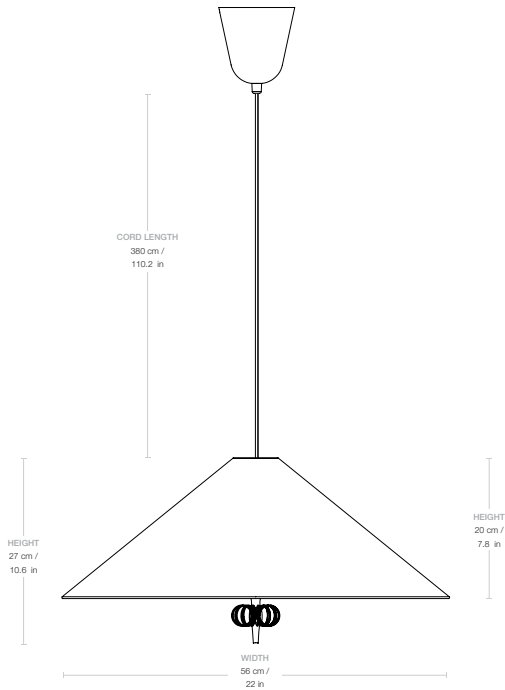

LAMP WIDTH	56 cm / 22 in
LAMP DEPTH	56 cm / 22 in
LAMP HEIGHT	27 cm / 10.6 in
SHADE DIAMETER	56 cm / 22 in
SHADE HEIGHT	20 cm / 7.8 in
CANOPY DIAMETER	11 cm / 4.3 in
CANOPY HEIGHT	11 cm / 4.3 in
CORD LENGTH	380 cm / 149.6 in

Weight

TOTAL WEIGHT	1,75 kg / 3.85 lbs
---------------------	--------------------



Number of parcels	1
PACKAGING LENGTH	62,5 cm / 24.6 in

PACKAGING WIDTH	67,5 cm / 26.5 in
PACKAGING HEIGHT	33 cm / 13 in
PACKAGING WEIGHT	1,15 kg / 2,5 lbs
GROSS WEIGHT	2,9 kg / 6.4 lbs

Electrical Specifications

BULB SOCKET	2 x E26
RECOMMENDED BULB	6-10W LED, 810lm
DIMMER	No
SWITCH	No
VOLTAGE	120V
BULB INCLUDED	No

Test & Certifications

CERTIFICATION	 
ISOLATION CLASS	II
IP CLASSIFICATION	20



CARE INSTRUCTIONS

Daily cleaning can be done by wiping the frame with a clean dry cloth. Should the surface need more attention this can be cleaned with water and a light detergent or soap applied with a damp cloth. Wipe after with a clean dry cloth. Avoid any abrasive materials.

TROUBLESHOOTING

If lamp does not light, turn off the power. Check the bulb for a broken filament. Replace bulb if necessary, then turn it on. If the lamp still does not light, please contact customer service at the local dealer. If the external flexible cable or cord of this lamp is damaged, it must be replaced by a qualified electrician in order to avoid a hazard.

TECHNICAL INFORMATION

Light sources: 2x E27, Max. 10W LED, 810 Lumen.
Turn power off when changing light bulb. Isolation class II. The lamp is not approved for outdoor use or use in damp/wet rooms (IP20).

SAFETY INSTRUCTIONS

CAUTION: Keep lamp away from curtains, bedding linens, and any other flammable materials. Do not look directly at lighted bulb. Turn off / unplug and allow lamp to cool before replacing bulb, cleaning or other maintenance. Do not use in the bathroom or damp places.
Do not exceed recommended wattage.
In case of any doubt, please contact a qualified electrician.



For enquiries contact GUBI A/S - CVR: 17940384
Orientkaj 18-20. 2150 Nordhavn. Copenhagen, Denmark
T +45 69 15 60 60 – order@gubi.com
GUBI.COM

159-20-005-01 Assembly Instructions 1967 Pendant_EU

GUBI

ASSEMBLY INSTRUCTIONS

for

1967 Pendant

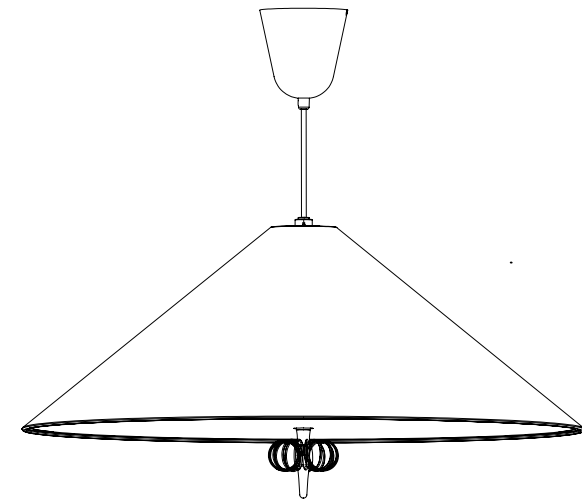

CONTENTS

1967 Pendant

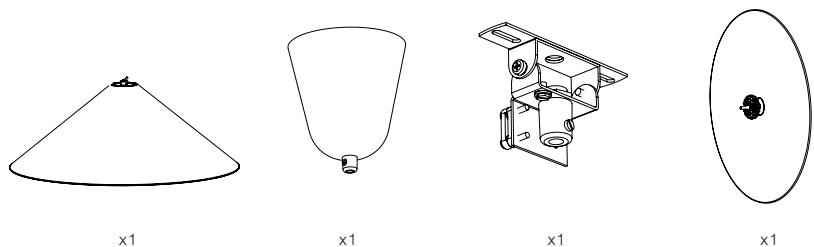

1.

Attach ceiling bracket to the built-in outlet or directly on the ceiling with proper screws.

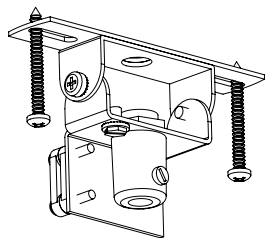

2.

Pull cable through the canopy.

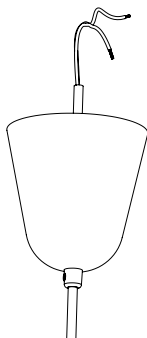

3.

Pull the cable through the cable clamp in the ceiling bracket.

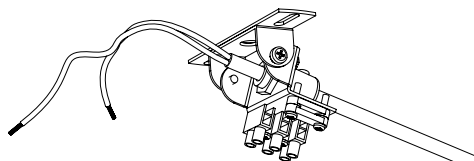

4.

When the right height for the pendant has been found lock the side screw on the cable clamp (A).

If connecting to mains outside the canopy connect pendant directly to the outlet (B).

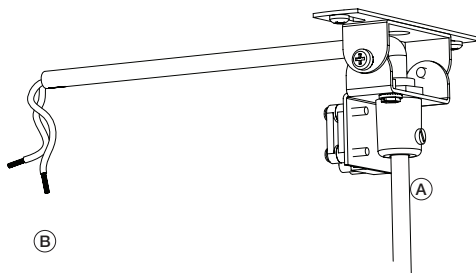

5.

Or cut lamp cable off and connect to the mains cables with the screw terminals (a). Remember to connect all grounding wires.

Do not forget to secure the mains cable in the cable clamp (b).

If ceiling bracket is mounted on a built-in outlet cut lamp cable off and connect to terminal connector (a). Connect mains wires to the other side of the terminal connector (c).

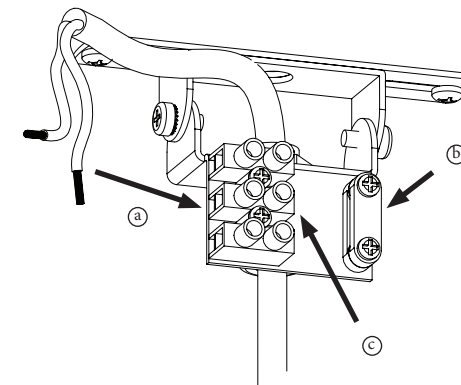

6.

Slide the canopy up the cable and push it against the ceiling while securing it with the side screw (A).

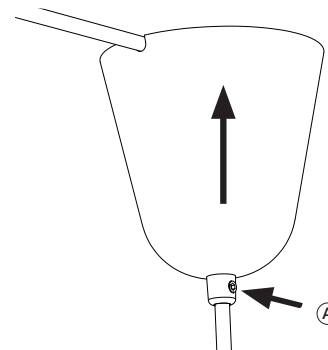

7.

Insert light bulbs in the lamp.

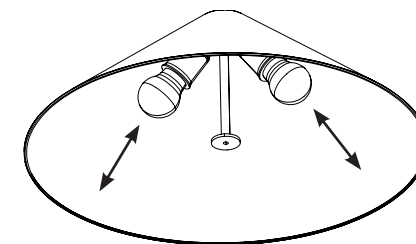

8.

Lift the fabric disc with two hands and place it in the center of the lamp. You will hear a click when the disc is in place.

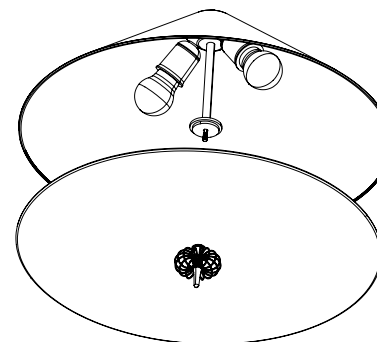

9.

Turn the center handle to secure the fabric diffuser to the lamp.

