



Pacific Scientific Energetic Materials Co.

< < < < MATERIAL SAFETY DATA SHEET > > > >

1. CHEMICAL PRODUCT AND COMPANY IDENTIFICATION

PRODUCT NAME: Cartridge Assembly
TRADE NAME(S) / SYNONYM(S): fire extinguisher cartridge; BNCP 5 BALL M's FIREX (replaces 2-100000)
PRODUCT NUMBER(S): 2-102520-1 [30903930]
2-101418-1 (in-house, w/o protective features)
2-102520-2 [30900000]
2-101418-2 (in-house, w/o protective features)
MSDS NUMBER / SPECIFYING LETTER: 00233 I
REVISION DATE: 7 June 2001
SHIPPING REFERENCE NUMBER: US DOT Competent Authority: EX-0106015
MANUFACTURER: Danaher Corporation - Pacific Scientific Energetic Materials Co. 7073 West Willis Road, #5002 Chandler, Arizona 85226-5111
TELEPHONE NUMBERS: (520) 796-1100 [6am-4pm MST] (520) 796-1243 FAX (800) 535-5053 Infotrac [24-hr] [website - www.psemc.com]

2. COMPOSITION / INFORMATION ON INGREDIENTS

HAZARDOUS INGREDIENTS (* - below required reporting levels per OSHA, 29 CFR § 1900.1200)

COMPONENT NAME / CAS NUMBER: hexanitrostilbene (HNS) / 20062-22-0
WEIGHT PERCENTAGE: < 1 %*

COMPONENT NAME / CAS NUMBER: tetraammine-*cis-bis*(5-nitro-2H-tetraazolato-N²) cobalt^{III} perchlorate (BNCP) / 178959-25-6
WEIGHT PERCENTAGE: < 1 %*

COMPONENT NAME / CAS NUMBER: zirconium, metal powder / 7440-67-7
WEIGHT PERCENTAGE: < 0.1 %*

COMPONENT NAME / CAS NUMBER: potassium perchlorate (KP) / 7778-74-7
WEIGHT PERCENTAGE: < 0.1 %*

COMPONENT NAME / CAS NUMBER: graphite [C] / 7782-42-5
WEIGHT PERCENTAGE: < 0.1 %*

COMPONENT NAME / CAS NUMBER: difluoroethene-hexafluoropropene-tetrafluoroethene terpolymer / 25190-89-0
WEIGHT PERCENTAGE: < 0.1 %*

NET EXPLOSIVE WEIGHT (NEW): 332 - 362 mg

PRODUCT: fire extinguisher cartridge	PAGE 2 OF 9
MSDS NUMBER: 00233	REVISION: 7 June 2001

3. HAZARDS IDENTIFICATION

EMERGENCY OVERVIEW

WARNING: Explosive Product ! Do not attempt to manually fight fires. Product may be sensitive to shock, impact, friction, electrostatic discharge, high pressure or high temperature. Product may ignite and explode if exposed to any of these conditions, releasing toxic fumes, heat, shock waves and container fragments.

POTENTIAL HEALTH EFFECTS (ACUTE AND CHRONIC)

EYES: The product is sealed preventing exposure to the hazardous ingredients inside. If product seal ruptures exposing hazardous ingredients inside, discard product avoiding contact with the eyes. Exposure to ignition products may cause eye irritation.

SKIN: The product is sealed preventing exposure to the hazardous ingredients inside. If product seal ruptures, discard product avoiding contact with the skin. Poses little or no immediate hazard. Exposure to ignition products may cause skin irritation.

INHALATION: The product is sealed preventing exposure to the hazardous ingredients inside. Exposure to ignition products may cause respiratory irritation. Ignition products will contain zirconium, cobalt, chlorine and fluorine compounds, plus nitrogen oxides.

INGESTION: Not a hazard in normal industrial use. If product seal ruptures, discard product using proper protection. Some ingredients are highly poisonous by ingestion.

MEDICAL CONDITIONS AGGRAVATED BY EXPOSURE: Pre-existing pulmonary diseases such as emphysema, asthma, etc. may be aggravated by overexposure to ignition products.

CARCINOGENICITY (CANCER) LISTING STATUS

OSHA, NTP & NIOSH: Neither the product nor its hazardous components are listed

IARC: 2B - Limited Evidence [cobalt compound]

ACGIH: A3 - Animal Carcinogen [inorganic cobalt compound, as cobalt]

REFER TO SECTION 11, TOXICOLOGICAL INFORMATION, FOR ADDITIONAL DATA.

4. FIRST AID MEASURES

EYES: If exposed to container fragmentation, bandage eyes and transport. If exposed to ignition byproducts, remove contact lenses immediately, flush with water for at least 15 minutes, occasionally lifting upper and lower eyelids. Seek medical attention if needed.

SKIN: Wash off any residue with soap and warm water. Seek medical attention if irritation develops.

INHALATION: Remove to fresh air. If breathing has stopped, give artificial respiration. If breathing is difficult, administer oxygen. Seek immediate medical attention.

INGESTION: Seek immediate medical attention.

PRODUCT: fire extinguisher cartridge	PAGE 3 OF 9
MSDS NUMBER: 00233	REVISION: 7 June 2001

NOTE TO PHYSICIAN: Supportive care. Product ignition produces small quantities of zirconium, cobalt, chlorine and fluorine compounds, plus nitrogen oxides. Treatment based on judgement of the physician in response to reactions of the patient.

5. FIRE FIGHTING MEASURES

FLAMMABLE PROPERTIES

FLASH POINT: not applicable
METHOD USED: not applicable
LOWER FLAMMABLE LIMIT: self-oxidizing
UPPER FLAMMABLE LIMIT: self-oxidizing

AUTOIGNITION TEMPERATURE: $\geq 480^{\circ}\text{F}$ ($\geq 250^{\circ}\text{C}$) [BNCP]

FIRE AND EXPLOSION HAZARD: WARNING - Explosive Product ! Product may be sensitive to shock, impact, friction, electrostatic discharge, high pressure or high temperature. Must not be confined if burning. Product may deflagrate or detonate if exposed releasing toxic fumes, heat, shock waves and container fragments.

EXTINGUISHING MEDIA: Permanently-installed, automatic water sprinkler / deluge system is recommended.

FIRE FIGHTING INSTRUCTIONS: Do not attempt to manually fight fires. In case of fire, personnel should immediately evacuate the area, using as much protective cover as possible and activate deluge and alarm systems.

HAZARDOUS COMBUSTION PRODUCTS: Extreme heat and toxic gases containing zirconium, cobalt, chlorine and fluorine compounds; plus nitrogen oxides may be emitted during ignition.

6. ACCIDENTAL RELEASE MEASURES

SMALL SPILL: If product seal ruptures, barricade area, eliminate ignition sources, use a soft bristle brush and a conductive rubber pan or rubber shovel to clean-up spills. Use conductive containers and ground all containers when transferring the spilled material. Refer to Section 9 for the proper desensitizing agent to wet and desensitize the spilled material.

LARGE SPILL

SOIL SPILL: Remove all contaminated soil to dispose of as hazardous waste.

AIR RELEASE: Not applicable

WATER SPILL: Flush with copious amounts of water. Collect water to dispose of as hazardous waste.

OCCUPATIONAL SPILL: If product seal ruptures, barricade area and eliminate ignition sources. Refer to SMALL SPILL above.

7. HANDLING AND STORAGE

HANDLING: Handling and use of explosives and related dangerous materials must be limited to personnel who are specifically authorized and trained in this area.

PRODUCT: fire extinguisher cartridge	PAGE 4 OF 9
MSDS NUMBER: 00233	REVISION: 7 June 2001

Refer to the Department of Defense Contractors Safety Manual number DOD4145.26M, including sources listed within, and any other appropriate information for detailed instructions regarding proper handling, storage, use and disposal of explosives and related dangerous material.

STORAGE: Store in approved storage magazines only. Storage and handling must conform to appropriate quantity / distance requirements, barricading, grounding and personnel material limits. Keep product cool and dry in storage.

8. EXPOSURE CONTROLS / PERSONAL PROTECTION

PERSONAL PROTECTIVE EQUIPMENT (PPE)

EYE PROTECTION: Industrial safety glasses or goggles must be worn when handling any type of explosive product.

SKIN PROTECTION

GLOVES: Impervious, static-dissipative gloves are recommended if product seal ruptures.

CLOTHING: High cotton-content clothing and underclothing, as well as *conductive shoes or legstat(s), wristat(s) and a static-dissipative coat*, are recommended to avoid static electricity build-up.

EMERGENCY WASH FACILITY: Eye washing capability is required.

RESPIRATORY PROTECTION: Appropriate NIOSH / MSHA-approved respiratory protection is recommended if exposed to particulate matter, and, for protection against toxic gaseous ignition products, but should not be necessary with normal handling.

OTHER PROTECTION: None indicated.

ENGINEERING CONTROLS: Effective shielding is recommended for personnel when handling these devices. Humidity control (i.e. higher relative humidity, > 60% as recommended by DOD) reduces or prevents static electricity build-up. Explosion-proof equipment is required when operating with exposed explosive materials.

VENTILATION

LOCAL: Not required.

SPECIAL: Explosion-proof electrical is required, where applicable.

MECHANICAL: General-coverage, moderate-flow, is recommended for particulate and ignition product removal.

EXPOSURE GUIDELINES:

COMPONENT: tetraammine-*cis-bis*(5-nitro-2H-tetrazolato-N²)
cobalt^{III} perchlorate (BNCP)

OSHA TWA: 0.1 mg/m³ [cobalt (Co) dust / fume]

OSHA STEL: not found

ACGIH TWA: 0.02 mg/m³ [as cobalt (Co), inorganic compound]

ACGIH STEL: not found

PRODUCT: fire extinguisher cartridge	PAGE 5 OF 9
MSDS NUMBER: 00233	REVISION: 7 June 2001

OTHER(S): **NIOSH TWA:** 0.05 mg/m³ [cobalt (Co) dust / fume]
IDLH: 20 mg/m³ [as cobalt (Co)]

COMPONENT: zirconium, metal powder [Zr]

OSHA TWA: 5 mg/m³
OSHA STEL: not found
ACGIH TWA: 5 mg/m³
ACGIH STEL: 10 mg/m³
OTHER: **NIOSH TWA:** 5 mg/m³
NIOSH STEL: 10 mg/m³
IDLH: 50 mg/m³

COMPONENT: graphite [C]

OSHA TWA: 15 million parts / ft³ [2.5 mg/m³ (respirable frxn) - 1989 vacated PEL]
OSHA STEL: not found
ACGIH TWA: 2 mg/m³ [respirable fraction]
ACGIH STEL: not found
OTHER: **NIOSH TWA:** 2.5 mg/m³ [respirable fraction]
IDLH: 1250 mg/m³

COMPONENTS: hexanitrostilbene (HNS)
 potassium perchlorate
 difluoroethene-hexafluoropropene-tetrafluoroethene terpolymer

OSHA TWA: 15 mg/m³ [total],
 5 mg/m³ [respirable dust fraction] (PNOR)
OSHA STEL: not found
ACGIH TWA: 10 mg/m³ [inhalable particulate],
 3 mg/m³ [respirable particulate] (PNOS)
ACGIH STEL: not found
OTHER: none found

9. PHYSICAL AND CHEMICAL PROPERTIES

APPEARANCE: metallic ordnance hardware
ODOR: odorless
PHYSICAL STATE: solid
pH @ 25°C: not determined
VAPOR PRESSURE: not applicable, sealed product
VAPOR DENSITY: not applicable, sealed product
BOILING POINT: not applicable

PRODUCT: fire extinguisher cartridge
 MSDS NUMBER: 00233

PAGE 6 OF 9
 REVISION: 7 June 2001

MELTING POINT: not applicable
SOLUBILITY IN H₂O: negligible
SPECIFIC GRAVITY (H₂O=1): greater than 1
BULK DENSITY: greater than 1, identical to specific gravity
CHEMICAL FAMILY: not applicable
MOLECULAR WEIGHT: not applicable
MOLECULAR FORMULA: not applicable
VISCOSITY: not applicable
EVAPORATION RATE: not applicable, sealed product

DECOMPOSITION TEMP: ≥ 480°F (≥ 250°C) by auto-ignition [BNCP]

DESENSITIZING AGENT: CAUTION: The product may only be desensitized if large volumes of water or mineral oil come in contact with the explosive components inside. Sealed units should be shunted and disposed of in accordance with Section 13.

VOC CONTENT: none

10. STABILITY AND REACTIVITY

CHEMICAL STABILITY: This explosive product is stable if handled properly. Avoid conditions listed below.

CONDITIONS TO AVOID: Shock, impact, friction, electrostatic discharge, high pressure, high temperature, open flame and chemical or physical contamination.

INCOMPATIBILITY WITH OTHER MATERIALS: The product is sealed preventing exposure to the hazardous ingredients inside. If the seal ruptures, remove all other hazardous materials.

HAZARDOUS DECOMPOSITION PRODUCTS: Extreme heat and toxic gases containing zirconium, cobalt, chlorine and fluorine compounds, plus nitrogen oxides may be emitted during ignition.

HAZARDOUS POLYMERIZATION: Will not occur.

11. TOXICOLOGICAL INFORMATION

HEALTH HAZARDS / TOXICOLOGY: The product is sealed preventing exposure to the hazardous ingredients inside. If the seal ruptures, remove all other hazardous materials.

HNS and BNCP (as a nitro compound of an aromatic hydrocarbon): Skin absorption and inhalation are usual routes of entry for these materials. The effects of acute exposure are the reduction of oxygen-carrying power of the blood and depression of the nervous system. Chronic exposure may cause anemia, moderate cyanosis, fatigue, slight dizziness, headache, insomnia and weight loss. Prolonged chronic exposure may lead further to liver and/or kidney damage, manifesting as acute yellow atrophy and toxic hepatitis or fatty degeneration of the kidneys.

LD₅₀: no data found

PRODUCT: fire extinguisher cartridge	PAGE 7 OF 9
MSDS NUMBER: 00233	REVISION: 7 June 2001

BNCP (as a cobalt compound): Low toxicity by ingestion. Ingestion of soluble salts produces nausea and vomiting by local irritation; possibly can cause liver and kidney damage. Locally, cobalt has been shown to cause dermatitis and hypersensitivity of the skin. Animal carcinogen (ACGIH) and suspected human carcinogenicity. Further reports, state both confirmed and questionable carcinogen with experimental neoplastigenic and tumorigenic data.

LD₅₀: no data found

potassium perchlorate and BNCP (as a perchlorate): Severe irritant to skin, eyes and mucous membranes. Implicated in aplastic anemia. Absorption can cause methemoglobinemia and kidney injury. An experimental teratogen.

LD₅₀: no data found

zirconium: Inhalation may lead to lung granulomas. Fine zirconium powder readily generates respirable dust, which is retained in the lungs. Fine powder imbeds in skin, eyes and other exposed tissues.

LD₅₀: no data found

graphite: Moderately toxic by intravenous route. Experimental reproductive effects.

LD₅₀: 440 mg/kg; intravenous; mouse

difluoroethene-hexafluoropropene-tetrafluoroethene terpolymer: ACGIH recommends that air concentrations of thermal decomposition products (fumes) of PTFE, a closely-related fluoropolymer, be controlled at 'as low as possible' levels. No toxicological information found, except references to 'polymer fume fever'.

LD₅₀: no data found

12. ECOLOGICAL INFORMATION

The product is sealed preventing exposure to the hazardous ingredients inside. If the seal ruptures, the small amount of hazardous ingredients inside should have no ecological impact.

13. DISPOSAL CONSIDERATIONS

RCRA HAZARDOUS WASTE CODES (product as manufactured):

D003 - reactive characteristic

WASTE DISPOSAL METHOD: Explosives or related dangerous material should be destroyed by open burning / open detonation in an approved incinerator, or by another approved method such as chemical treatment / destruction. Contaminated property must not be buried.

REGULATIONS GOVERNING TREATMENT, STORAGE AND DISPOSAL OF HAZARDOUS WASTE IS SUBJECT TO CHANGE AND REINTERPRETATION. SINCE THE OWNER OF THE WASTE IS RESPONSIBLE FOR PROPER DISPOSAL, CHECK WITH FEDERAL, STATE AND LOCAL ENVIRONMENTAL AGENCIES IF IN DOUBT OF THE REQUIREMENTS OF APPLICABLE LAWS, RULES AND REGULATIONS. TREATMENT, STORAGE AND DISPOSAL MUST BE IN ACCORDANCE WITH ALL APPLICABLE FEDERAL, STATE AND LOCAL LAWS, RULES AND REGULATIONS.

PRODUCT:	fire extinguisher cartridge	PAGE 8 OF 9
MSDS NUMBER:	00233	REVISION: 7 June 2001

14. TRANSPORT INFORMATION

U.S. DEPARTMENT OF TRANSPORTATION INFORMATION: This product is regulated as a US DOT Hazardous Material. Applicable regulations are found in title 49 of the Code of Federal Regulations. An authorized carrier in full compliance with these regulations must be used to transport this product. This product may not be mailed through the US Postal system.

UN PROPER SHIPPING NAME / NUMBER: Cartridges, power device / UN0276

UN CLASSIFICATION CODE: 1.4C

PACKAGING GROUP: II

LABEL(S) REQUIRED: EXPLOSIVE 1.4C, CARGO AIRCRAFT ONLY

APPLICABLE PACKAGING SECTION: 49 CFR § 173.62 non-bulk [PI-134], plus special provision 110 per 49 CFR § 172.102

DOT REPORTABLE QUANTITY (RQ): 100 lbs. (45.4 kg) per 49 CFR § 172.101, Appendix (D003 reactivity)

OTHER TRANSPORTATION INFORMATION: For general emergency response guidance, actions, and potential hazards, refer to the "2000 Emergency Response Guidebook" or 2000ERG, **GUIDE NUMBER 114**.

15. REGULATORY INFORMATION**U.S. REGULATIONS****FEDERAL**

OSHA: Regulated under 29 CFR § 1910.1200

TSCA: All hazardous components should be reported on the inventory.

CERCLA RQ: 100 lbs. (45.4 kg) [D003 reactivity]

SARA - SECTION 302 TPQ: Not an Extremely Hazardous Substance.

- **SECTION 304 RQ:** See CERCLA RQ.

- **SECTION 313:** Reportable [cobalt compound]

STATES

CALIFORNIA PROPOSITION 65: The product and its hazardous components are not on their list.

NEW JERSEY RIGHT-TO-KNOW: The product (as EXPLOSIVES C) and the components, zirconium, potassium perchlorate, HNS and BNCP (as a cobalt compound and a perchlorate, inorganic, n.o.s.), are on the Right-to-Know Hazardous Substance List (rev. 3/93), which consists of both the Workplace Hazardous Substance List and the Environmental Hazardous Substance List. Zirconium and potassium perchlorate are on the Special Health Hazard Substance List.

PRODUCT:	fire extinguisher cartridge
MSDS NUMBER:	00233

PAGE 9 OF 9
REVISION: 7 June 2001

PENNSYLVANIA RIGHT-TO-KNOW: The components that are listed, zirconium, potassium perchlorate, graphite and BNCP (as a cobalt compound), are on the Hazardous Substance List. Cobalt compounds are included as Environmental Hazards. None are included as Special Hazardous Substances.

INTERNATIONAL REGULATIONS

To be determined

16. OTHER INFORMATION

HMIS RATINGS (Sealed product rating):

HEALTH: 1 FLAMMABILITY: 0 REACTIVITY: 4
PERSONAL PROTECTION: A + X

CERCLA or NFPA RATINGS (SCALE 0-4): not yet determined

REVISION HISTORY

Initial issue: 24 June 99, ANSI Z400.1

PREPARED BY: J. Geving - Environmental, Health & Safety

THE INFORMATION, RECOMMENDATIONS AND SUGGESTIONS IN THIS DATA SHEET ARE BASED ON AVAILABLE DATA BELIEVED TO BE ACCURATE AND RELIABLE. IT IS THE RESPONSIBILITY OF THE USER TO DETERMINE THE SUITABILITY FOR USE OF THIS PRODUCT OR USE IN COMBINATION WITH ANY OTHER DEVICE, MATERIAL OR PROCESS. NO WARRANTY, EITHER EXPRESSED OR IMPLIED, IS MADE CONCERNING THE EFFECTS OF USE OR THE RESULTS TO BE OBTAINED. NOR DOES PACIFIC SCIENTIFIC ENERGETIC MATERIALS COMPANY ASSUME ANY LIABILITY ARISING OUT OF USE, STORAGE, HANDLING OR DISPOSAL OF THE PRODUCT REFERRED TO HEREIN. TO PROMOTE SAFE USE OF THIS PRODUCT, THE USER SHOULD NOTIFY HIS EMPLOYEES, AGENTS, CONTRACTORS AND CLIENTS OF THE PRODUCT HAZARDS AND SAFETY INFORMATION AFTER BECOMING FAMILIAR WITH THIS DATA.

Copyright 2001

Pacific Scientific Energetic Materials Co.

All Rights Reserved



DEPARTMENT OF THE TREASURY
BUREAU OF ALCOHOL, TOBACCO AND FIREARMS

APR 19 2002

902030:CJY
55.32
5400

Mr. Kenneth Nevill
Pacific Scientific
11700 North West 102nd Road, Suite 6
Miami, Florida 33178

Dear Mr. Nevill:

This is in response to your telephone call on December 13, 2001, in which you requested that certain parts be added to your approved variance letter dated December 12, 2001. You have requested that these parts be exempted from the regulations contained at 27 CFR, Part 55.

You have described these devices as being designed and intended for use in aircraft fire extinguishers. The devices are explosive cartridges that rupture a thin membrane and allow a gas contained in the extinguisher to be emitted on a flame. Furthermore, you indicated each of the below listed devices contain a maximum of 420 milligrams of explosive material.

In your letter, you provided a comprehensive listing of the devices, by part number, that you are requesting to be exempted by way of 27 CFR 55.32, Special explosive devices. All of these devices have been assigned the following United States Department of Transportation (DOT), approval numbers:

EX-0106015	EX-9507054	EX-8611120	EX-8701156
EX-8701111	EX-8701157	EX-9012166	EX-8701158
EX-9012167	EX-8704025	EX-9012168	EX-9012169
EX-9012170	EX-8701158A	EX-8701159	EX-8711182
EX-8711183			

Mr. Kenneth Nevill

You stated that all of these devices have the common and specific purpose to be used in aircraft fire extinguisher systems only. The devices all contain 420 milligrams of explosive material or less and that the devices vary only in external dimension.

After reviewing your attachments, we have determined that these devices, as described, do not pose a threat to public safety when possessed and used for their intended purpose. Therefore, we are exempting these items from the provisions of 27 CFR, Part 55, in accordance with the regulation at 27 CFR 55.32.

This exemption applies only to the items listed in your letter dated February 5, 2002 (attached to this letter). Any alterations to these items, or the manufacture of different items, will render this exemption void and necessitate a separate request for exemption.

Although we have determined that these devices are not regulated, the explosive materials used in their manufacture are subject to all of the applicable provisions of 27 CFR, Part 55. Any explosive materials removed from these devices are also subject to regulation.

This variance may be modified or rescinded should ATF determine that it poses a threat to public safety or causes the Government to incur additional costs to administer. This approval does not convey any rights or privileges contrary to any other Federal, State, and/or local law. A copy of this letter should be made a part of your permanent records and be made available for inspection by any ATF officer.

Mr. Kenneth Nevill

We trust that the foregoing has been responsive to your request. Please feel free to contact Specialist Chad Yoder in the Public Safety Branch at 202-927-7930 if you have any additional questions.

Sincerely yours,

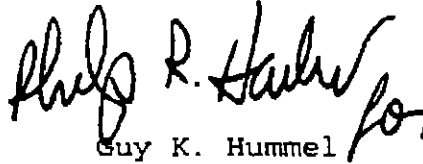
A handwritten signature in black ink, appearing to read "Guy K. Hummel" with a stylized flourish at the end.

Guy K. Hummel
Chief, Arson and Explosives
Programs Division

Attachment

C: Division Director/Director, Industry Operations,
Miami Field Division
Area Supervisor, Miami Area Office
Explosives Industry Analyst



U.S. Department of Justice

Bureau of Alcohol, Tobacco,
Firearms and Explosives

SEP 14 2004

Washington, DC 20226

www.atf.gov

902030:GT
03-0486
555.32
5400

Larry T. Constantino
Pacific Scientific
HTL/Kin-Tech Division
1800 Highland Avenue
Duarte, California 91010

Dear Mr. Constantino:

This is in response to your letter dated July 24, 2004, to the Bureau of Alcohol, Tobacco, Firearms and Explosives (ATF). You requested that we add several devices to your approved exemption letters dated December 12, 2001, and June 20, 2002. You have also requested that your completed cartridge-actuated devices be exempted from the regulations contained in 27 CFR, Part 555.

Your initial request was submitted in August 27, 2003. After reviewing the request, we concluded that your Miami, Florida, office submitted the same request and received an approved exemption letter from ATF. Therefore, in this letter we will address only the devices that were listed on your July 24, 2004, letter/facsimile. You stated that these devices are similar to the prior devices that we approved for exemption, that they only differ in explosive compositions and that they perform the same actions as previous devices.

You stated that the devices are used in cable cutters, aircraft fire suppression systems, and emergency escape slides. The cartridges contains 362 milligrams or less of explosive material. The devices are classified by the Department of Transportation as Cartridge, Power Devices, 1.4. You are requesting the following part numbers to be exempt:

30900000M	30903860	30903892	.30903925-1	36400048-1
30903801	30903861	30903894	30903928	36400049-1
30903822	30903870	30903895	30903931	52000828-1
30903824	30903871	30903896	30903946	52000859-1
30903827	30903872	30903898	30903947	52000868-1
30903828	30903874	30903899	30903948	51300325-1, -4
30903836	30903875	30903912	30903973	51300043-1

Mr. Larry T. Constantino

30903845	30903876	30903913	2-100420	53000399-1
30903856	30903889	30903915	2-100560	30180155 REV. H
30903857	30903890	30903916	52000735-1, -2	36400048-1
30903859	30903891	30903924-1, -2	36400049-1	52000828-1
52000859-1	52000868-1			

This exemption applies only to the assembled cartridge devices described and numbered above. Any alterations to these devices, or the manufacture of different devices, will render this exemption void and necessitate a separate request for exemption.

Although, we have determined that these devices are not regulated, the explosive materials used in their manufacture are subject to all of the provisions of 27 CFR, Part 555. Any explosive materials removed from this device are also subject to regulation.

We trust the foregoing is responsive to your request. If you have questions please contact the Explosives Industry Programs Branch at (202) 927-2310.

Sincerely yours,



Mark A. Siebert
Deputy Chief, Arson and Explosives
Programs Division

c: Special Agent in Charge, Los Angeles Field Division
Area Supervisor, Los Angeles Field Office
Chief, National Licensing Center

SERVICE INFORMATION LETTER

TO: OWNERS/OPERATORS OF PACIFIC SCIENTIFIC
COMPANY POWER ACTIVATING DEVICES.
(CARTRIDGES)

SUBJECT: INFORMATION REGARDING THE HANDLING AND
TESTING OF CARTRIDGES.

PURPOSE: THIS SERVICE INFORMATION LETTER (SIL)
DESCRIBES THE SUGGESTED PROCEDURE TO
HANDLE AND TEST POWER ACTIVATING DEVICES.

1. INTRODUCTION

The following information describes a suggested procedure of handling and maintaining of power activating devices. (industry known as cartridges) It is not the only accepted procedure for handling these items. Every site must design, develop, and install an acceptable process based on needs and situations.

2. SCOPE

This SIL involves all Pacific Scientific cartridge part numbers only.

3. REFERENCE

CMM's
Pacific Scientific Safety Manual
ATA Regulations
IATA Regulations
DOT Regulations

4. COMPLIANCE

None required. This document is for information only. The information enclosed replaces Technical Bulletin 83-2a and 83-2b.

5. SAFETY

The following precautions are general. They do not apply to any specific procedure but must be followed by persons that handle power device cartridges.

SIL NO. 26-0233F
May 10, 2007

SERVICE INFORMATION LETTER

5. **SAFETY -cont-**

A. COMMON SENSE

Power device cartridges should be handled only by people who are aware of their function and their potential. They should be handled only when needed. Persons handling power device cartridges should not work alone. Assistance and emergency information should always be considered before accomplishing tasks.

B. SUPERVISOR RESPONSIBILITY

Individuals that supervise people that handle power device cartridges should insure the following:

1. Supervise all individuals handling power device cartridges.
2. Address precautions before any work is accomplished and resolve safety issues that appear during operations.
3. Enforce all safety instructions and regulations.
4. Insure all emergency contact information is researched, displayed, and understood before any work is accomplished.

C. ISOLATE FROM LIVE CIRCUITS

Power device cartridges are activated electrically. Live circuits always have stray currents. Insure they do not contact power device cartridges.

6. **DEFINITIONS**

The following definitions apply to terms used in this publication.

Bridgewire: A measured wire built into an ignition element that is connected to the electrical leads of a device.

Hermetic Seal: Hermetically sealed devices are welded or solder sealed versus sealed with epoxy resin.

Manufacture Date: Date unit is manufactured. Date is in code and does not affect service life.

Non-hermetic Seal: Devices that are sealed using epoxy resins.

Power Device Cartridge: Explosive device to activate aircraft safety equipment

Service Date: The date in which the cartridge is considered in service.

Service Life: The length of time a cartridge may stay in service.

SERVICE INFORMATION LETTER

6. DEFINITIONS -cont-

Shunt: An insulating or grounding device that shields or grounds cartridges to prevent activation. There are two types:

Shunt Plugs ground each connector pin to the unit case preventing current flow to the bridgewire.

Faraday Cap insulates pins from receiving static current.

Total Life: The length of time a unit may be considered serviceable.

7. SHIPMENT INSPECTION

Follow instructions in specific documents provided by the users organization as to shipment inspections of power device cartridges. Insure that all units are properly identified and packaging is not damaged. If the packaging is damaged inspect the cartridge per specific technical documents.

8. GROUNDING POWER DEVICE CARTRIDGES

Find a location where cartridge handling can be processed without interference.

This area must be free of stray electrical currents and a lot of foot traffic. Insure all needed ESD components are available at this station. How ESD components are stationed is left to the station operator. How and why ESD components are used must be clearly understood before any cartridge operations begin. Follow guideline from ANSI or IEEE.

9. DESCRIPTION AND OPERATION

A. Description

Cartridges are power devices that are used to start a pressurized fire extinguisher's flow. Although there are two groups within these devices Pacific Scientific produces only the modern shock wave device.

The shock wave device produces a wave that breaks the enclosure disc or stem holding a plug. They can be found in hermetic or non-hermetic sealed units.

B. Operation

When a fire extinguisher is deployed a specified electrical current is routed to the cartridge. Current flows through the connector pins, into the bridgewire, making the bridgewire hot causing the power to ignite and produce a shock wave that ruptures the disc or housing of the fire extinguisher.

C. Specific Data

See Attachment Information Table 1

SERVICE INFORMATION LETTER

10. UNIT INSPECTION

Visually inspect all areas of the cartridge. Check for distortion on threads and electrical plug case. No cracks or dents allowed on cup area. Insure all pins will allow electrical plugs to engage. There should be no loose parts on the unit.

11. TESTING AND FAULT ISOLATION

WARNING: Insure all shunt devices or safety caps are installed before handling any cartridges.

WARNING: Testing of all cartridges should be accomplished while cartridge is install in the applicable safety fixture. See tool and fixture table for correct application.

Tools and Test Equipment

ITEM	PART NUMBER SPECIFICATION	SOURCE
Digital Multimeter	.10 ohm sensitivity, test current less than 0.04 amps in all switch positions	Commercially Available
Safety Chamber	83330118	Pacific Scientific
Safety Chamber	83330760	Pacific Scientific
Safety Chamber	83330759	Pacific Scientific
Safety Chamber	83330760	Pacific Scientific
Safety Chamber	83330764	Pacific Scientific
Safety Chamber	83330765	Pacific Scientific
Ground Strap and Circuit Tester	-	Commercially Available

A. Electrical Test

Extensive testing is conducted when each unit is manufactured. Pacific Scientific recommends that testing be limited to fault isolation only and only the areas to confirm faults. Connect test equipment to applicable pins and apply values per Electrical Schematic Diagram.

12. REPAIR

Repair is limited to the straightening of electrical pins. Electrical testing must be completed after the pins are corrected not prior to correction.

SERVICE INFORMATION LETTER

- 13. STORAGE**
Cartridges must be stored with shunt plugs or safety caps installed. They should be kept in a sealed anti static bag. New units are received from Pacific Scientific in the correct configuration. Units should be kept in a dry area below 100F and above 70F. see local regulations for Class S explosives.
- 14. TRANSPORTATION**
The following agencies are the regulatory bodies governing the transportation of cartridges. International Air Transport Association (IATA) Dangerous Goods Regulations DOT 49 CFT 173, Subpart C International Maritime Organization (IMO) Also consult any state or local regulatory bodies. Pacific Scientific Cartridge Exemptions EX 0105187, 0105188, and 2002030115 allow 1.4C cartridges to be shipped as 1.4S if packed in the stated manner. Please see the Pacific Scientific web site: www.pacscimiami.com for information and packing supplies.
- 15. REMOVAL OF OLD OR DEFECTIVE CARTRIDGES**
Cartridges are considered HAZMAT material and should be disposed of with that process. Consult certified HAZMAT waste removal companies to remove all cartridges.
- 16. ATTACHMENT**
SB 26-1121 Dated, March 06, 1998

SERVICE INFORMATION LETTER

ELECTRICAL SCHEMATIC DIAGRAMS

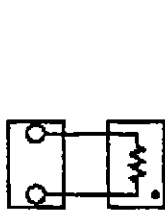

Figure 1



Figure 2

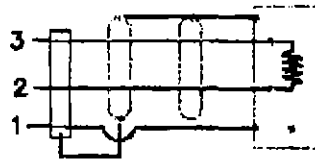

Figure 3

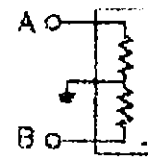

Figure 4

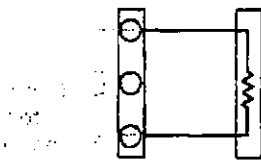

Figure 5

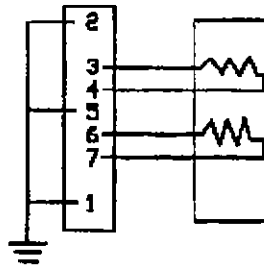

Figure 6

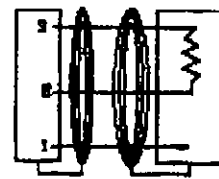

Figure 7

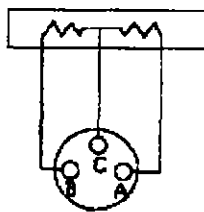

Figure 8

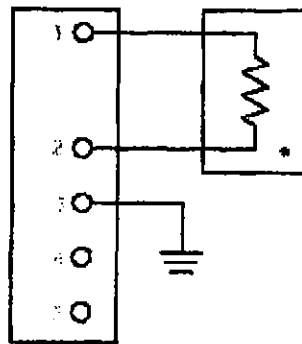

Figure 9

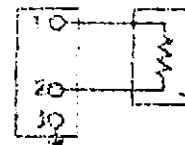

Figure 10

SERVICE INFORMATION LETTER

ELECTRICAL SCHEMATIC DIAGRAMS

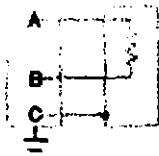

Figure 11

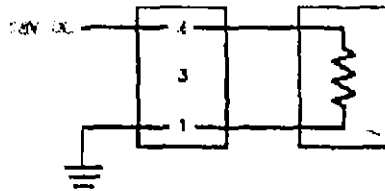

Figure 12

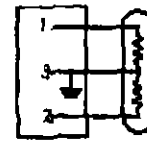

Figure 13

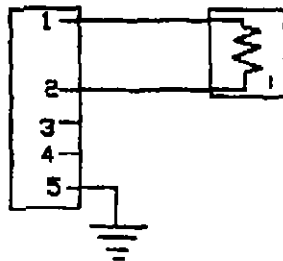

Figure 14

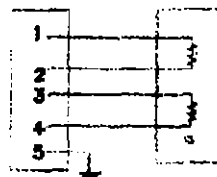

Figure 15



Figure 16

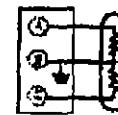

Figure 17

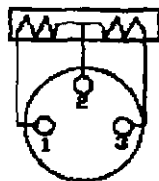

Figure 18

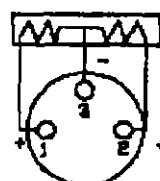

Figure 19

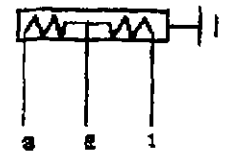

Figure 20

SERVICE INFORMATION LETTER

ELECTRICAL SCHEMATIC DIAGRAMS

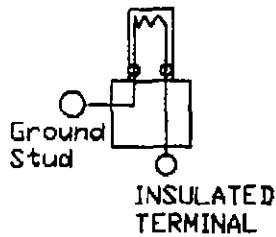

Figure 21



Figure 22

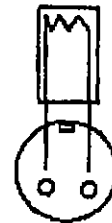

Figure 23

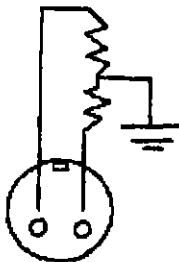

Figure 24

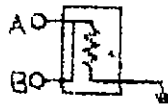

Figure 25

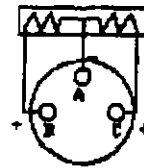

Figure 26

**PACIFIC SCIENTIFIC
CARTRIDGE POWER DEVICE**

TABLE 1

PIN / SUBSTITUTE	SUGGESTED YRS IN SVC	PROTECTIVE CAP OR EQUIVALENT	SAFETY CHAMBER	OPERATING VOLTAGE	BRIDGEWIRE RESISTANCE	SEE FIG	COMPONENT EXEMPTION	AUTHORITY	PROPER SHIPPING NAME	UN NO.	CLASS
13083-5	-	Shunt Tag 31575600	83330118	18-30 VDC	1.15 +/- 0.25 OHMS	21	CA-961204	EX-9611120	Cartridge, Power Device	UN0323	1.4S
13083-10	-	Shunt Tag 31575600	83330118	18-30 VDC	0.9 - 1.4 OHMS	22	CA-900233	EX-8701156	Cartridge, Power Device	UN0323	1.4S
13083-25	-	90802020	83330118	18-30 VDC	1.5 +/- 0.25 OHMS	23	CA-870133	EX-8701111	Cartridge, Power Device	UN0323	1.4S
13083-45	-	90802020	83330118	18-30 VDC	0.9 - 1.4 OHMS	24	CA-900233	EX-8701157	Cartridge, Power Device	UN0323	1.4S
13083-50	-	31040015	83330118	18-30 VDC	0.9 - 1.4 OHMS	18	CA-910322	EX-9012166	Cartridge, Power Device	UN0323	1.4S
309000000M	15/10	10-107950-81	83330118	18 -36 VDC	1.0 +/-0.1 OHMS	1	NONE	EX-0106015	Cartridge, Power Device	UN0276	1.4C **
30900400	-	Shunt Tag 31575600	83330118	18-30 VDC	0.8 - 1.4 OHMS	21	CA-900233	EX-8701158	Cartridge, Power Device	UN0323	1.4S
30903801	15/10	MS25043-10DA	83330118	18 -36 VDC	1.0 +/-0.1 OHMS	2	NONE	EX-0106015	Cartridge, Power Device	UN0276	1.4C *
30903819	-	Shunt Tag 31575600	83330118	18 - 30 VDC	1.15 +/- 0.25 OHMS	21	CA-910322	EX-9012167	Cartridge, Power Device	UN0323	1.4S
30903822	15/10	MS3723/59-112AN OR -112AC	83330118	18 - 36 VDC	1.0 +/-0.1 OHMS	3	NONE	EX-0106015	Cartridge, Power Device	UN0276	1.4C *
30903823	-	Shunt Tag 31575600	83330118	18 - 30 VDC	1.15 +/- 0.25 OHMS	21	CA-900233	EX-8701159	Cartridge, Power Device	UN0323	1.4S
30903824	-	Shunt Tag 31575600	83330118	18 - 30 VDC	1.15 +/- 0.25 OHMS	21	CA-870428	EX-8704025	Cartridge, Power Device	UN0323	1.4S
30903824-1	-	Shunt Tag 31575600	83330118	18 - 30 VDC	1.15 +/- 0.25 OHMS	21	CA-910322	EX-9012168	Cartridge, Power Device	UN0323	1.4S
30903827	-	MS25043-10DA	83330118	17 - 36 VDC	1.00 +/- .10 OHM	4	NONE	EX-0106015	Cartridge, Power Device	UN0276	1.4C *
30903827-1	15/10	MS25043-10DA	83330118	17 - 36 VDC	1.00 +/- .10 OHM	25	NONE	EX-0106015	Cartridge, Power Device	UN0276	1.4C *
30903827-2	15/10	MS25043-10DA	83330118	17 - 36 VDC	1.00 +/- .10 OHM	25	NONE	EX-0106015	Cartridge, Power Device	UN0276	1.4C *
30903828	15/10	MS3723/60-212AN OR-212 AN	83330760	18 - 36 VDC	1.0 +/-0.1 OHMS	5	NONE	EX-0106015	Cartridge, Power Device	UN0276	1.4C *
30903836	15/10	MS3723/60-114 AN OR -114	83330759	18 - 36 VDC	1.0 +/-0.1 OHMS	6	NONE	EX-0106015	Cartridge, Power Device	UN0276	1.4C *
30903845	15/10	MS3723/59-112AN OR -112AC	83330118	18 - 36 VDC	1.0 +/-0.1 OHMS	7	NONE	EX-0106015	Cartridge, Power Device	UN0276	1.4C *
30903849	-	MS3181-8C	83330118	18 - 30 VDC	1.15 +/- 0.25 OHMS	8	CA-871122	EX-8711182	Cartridge, Power Device	UN0323	1.4S

* Unit may be shipped as 1.4S, UN0323 with EX 2002030115, see paragraph 14

** Unit may be shipped as 1.4S, UN0323 with EX 0105187, see paragraph 14

*** Unit may be shipped as 1.4S, UN0323 with EX 0106188, see paragraph 14

PACIFIC SCIENTIFIC
CARTRIDGE POWER DEVICE

TABLE 1

P/N / SUBSTITUTE	SUGGESTED YRS	PROTECTIVE CAP or EQUIVALENT	SAFETY CHAMBER	OPERATING VOLTAGE	BRIDGEWIRE RESISTANCE	SEE FIG	COMPONENT AUTHORITY/ EXEMPTION	PROPER SHIPPING NAME	UN NO.	CLASS
30903860	6	M83723/60-1 8AN	8330118	18 - 30 VDC	1.15 +/- 0.25 OHMS	19	CA-871122	EX-8711183	Cartridge Power Device UN0323	1 4S
30903852	15/10	M83723/60-210AN OR-210 AN	8330118	18 - 36 VDC	1.0 +/-0.1 OHMS	9	NONE	EX-0106015	Cartridge Power Device UN0276	1 4C *
30903855	6	90802020	8330118	18 - 30 VDC	1.15 +/- 0.25 OHMS	21	CA-910322	EX-8012168	Cartridge Power Device UN0323	1 4S
30903856	15/10	M83723/60-110AN OR -110AC	8330118	18 - 36 VDC	1.0 +/-0.1 OHMS	9	NONE	EX-0106015	Cartridge Power Device UN0276	1 4C *
30903857	15/10	M83723/60-110AN OR -110AC	8330118	18 - 36 VDC	1.0 +/-0.1 OHMS	9	NONE	EX-0106015	Cartridge Power Device UN0276	1 4C *
30903859	15/10	M83723/60-18AN OR -18AC	8330118	18 - 36 VDC	1.0 +/-0.1 OHMS	10	NONE	EX-0106015	Cartridge Power Device UN0276	1 4C *
30903860	15/10	M83723/60-18AN OR -18AC	8330118	25 - 29 VDC	1.0 +/-0.1 OHMS	5	NONE	EX-9305040	Cartridge Power Device UN0323	1 4S
30903870	15/10	M83181-8RA	8330118	18 - 36 VDC	1.0 +/-0.1 OHMS	11	NONE	EX-0106015	Cartridge Power Device UN0276	1 4C **
30903871	15/10	M83723/60-114AN OR -114AC	8330764	18 - 36 VDC	1.0 +/-0.1 OHMS	6	NONE	EX-0106015	Cartridge Power Device UN0276	1 4C *
30903872	15/10	M83723/60-114 AN	8330765	18 - 36 VDC	1.0 +/-0.1 OHMS	6	NONE	EX-0106015	Cartridge Power Device UN0276	1 4C ***
30903872-1	15/10	M83723/60-114 AC	8330765	18 - 36 VDC	1.0 +/-0.1 OHMS	6	NONE	EX-0106015	Cartridge Power Device UN0276	1 4C *
30903874	15/10	M83723/60-110AN OR -110AC	8330118	18 - 36 VDC	1.0 +/-0.1 OHMS	9	NONE	EX-0106015	Cartridge Power Device UN0276	1 4C *
30903875	15/10	M83723/60-212AN OR-212 AC	8330764	18 - 36 VDC	1.0 +/-0.1 OHMS	12	NONE	EX-0106015	Cartridge Power Device UN0276	1 4C *
30903876	15/10	M83723/60-212AN OR-212 AC	8330765	18 - 36 VDC	1.0 +/-0.1 OHMS	12	NONE	EX-0106015	Cartridge Power Device UN0276	1 4C *
30903886	15/10	M83723/60-18AN	8330118	17 - 31 VDC	1.0 +/-0.1 OHMS	13	NONE	EX-0106015	Cartridge Power Device UN0276	1 4C **
30903889	15/10	M83723/60-28AN OR -28AC	8330760	18 - 36 VDC	1.0 +/-0.1 OHMS	10	NONE	EX-0106015	Cartridge Power Device UN0276	1 4C *
30903890	15/10	M83723/60-18AN OR -18AC	8330759	18 - 36 VDC	1.0 +/-0.1 OHMS	10	NONE	EX-0106015	Cartridge Power Device UN0276	1 4C *
30903891	15/10	M83723/60-210AN OR-210 AN	8330760	18 - 36 VDC	1.0 +/-0.1 OHMS	14	NONE	EX-0106015	Cartridge Power Device UN0276	1 4C *
30903894	15/10	M83723/60-112AN OR -112AC	8330760	18 - 36 VDC	1.0 +/-0.1 OHMS	10	NONE	EX-0106015	Cartridge Power Device UN0276	1 4C *
30903895	15/10	M83723/60-112AN OR -112AC	8330760	18 - 36 VDC	1.0 +/-0.1 OHMS	10	NONE	EX-0106015	Cartridge Power Device UN0276	1 4C *

* Unit may be shipped as 1.4S, UN0323 with EX 2002030115. see paragraph 14

** Unit may be shipped as 1.4S, UN0323 with EX 0105187. see paragraph 14

*** Unit may be shipped as 1.4S, UN0323 with EX 0105188. see paragraph 14

Attachment SIL 26-0233F

January 23, 2007

**PACIFIC SCIENTIFIC
CARTRIDGE POWER DEVICE**

TABLE 1

P/N /SUBSTITUTE	SUGGESTED YRS	PROTECTIVE GAP or EQUIVALENT	SAFETY CHAMBER	OPERATING VOLTAGE	BRIDGEWIRE RESISTANCE	SEE FIG	COMPONENT EXEMPTION	AUTHORITY/ PROPER SHIPPING NAME	UN NO.	CLASS
30903896	30903949	15/10 M83723/60-112AN OR -112AC	83330760	18 - 36 VDC	1.0 +/-0.1 OHMS	10	NONE	EX-0106015	Cartridge, Power Device UN0276	1.4C *
30303898	-	15/10 M83723/60-110AN OR -110AC	83330118	4 - 36 VDC	1.0 +/-0.1 OHMS	15	NONE	EX-0106015	Cartridge, Power Device UN0276	1.4C **
30903899	-	15/10 M83723/60-110AN OR -110AC	83330118	4 - 36 VDC	1.0 +/-0.1 OHMS	15	NONE	EX-0106015	Cartridge, Power Device UN0276	1.4C *
30903912	30903928	15/10 M83723/60-112AC	83330765	4 - 36 VDC	1.0 +/-0.1 OHMS	10	NONE	EX-0106015	Cartridge, Power Device UN0276	1.4C *
30903913	30903929	15/10 M83723/60-114 AC	83330764	18 - 36 VDC	1.0 +/-0.1 OHMS	10	NONE	EX-0106015	Cartridge, Power Device UN0276	1.4C *
30903920	-	6 MS3181-8C	83330118	18 - 30 VDC	1.15 +/- 0.25 OHMS	26	NONE	EX-9507054	Cartridge, Power Device UN0276	1.4C
30903924-1	30903965	6 MS2104/C06	83330118	18 - 30 VDC	1.15 +/- 0.25 OHMS	21	NONE	EX-9703145	Cartridge, Power Device UN0276	1.4C
30903925-1	62000725-1	15/10 AE83723/60-28RN	83330118	4 - 36 VDC	1.0 +/-0.1 OHMS	20	CA-850402	EX-8502243	Igniters UN0454	1.4S
30903927	30903822	15/10 M83723/59-112AN OR -112AC	83330118	18 - 36 VDC	1.0 +/-0.1 OHMS	3	NONE	EX-0106015	Cartridge, Power Device UN0276	1.4C *
30903928	30903912	15/10 M83723/60-112AC	83330765	4 - 36 VDC	1.0 +/-0.1 OHMS	10	NONE	EX-0106015	Cartridge, Power Device UN0276	1.4C *
30903929	30903913	15/10 M83723/60-114 AC	83330764	18 - 36 VDC	1.0 +/-0.1 OHMS	10	NONE	EX-0106015	Cartridge, Power Device UN0276	1.4C *
30903930	30900000M	15/10 10-101950-81	83330118	18 - 36 VDC	1.0 +/-0.1 OHMS	1	NONE	EX-0106015	Cartridge, Power Device UN0276	1.4C *
30903931	30903828	15/10 M83723/60-212AN OR-212 AN	83330760	18 - 36 VDC	1.0 +/-0.1 OHMS	5	NONE	EX-0106015	Cartridge, Power Device UN0276	1.4C *
30903932	30903836	15/10 M83723/60-114 AN OR -114 AC	83330759	18 - 36 VDC	1.0 +/-0.1 OHMS	6	NONE	EX-0106015	Cartridge, Power Device UN0276	1.4C *
30903933	30903862	15/10 MILL-C-83723/60-210AN OR-	83330118	18 - 36 VDC	1.0 +/-0.1 OHMS	9	NONE	EX-0106015	Cartridge, Power Device UN0276	1.4C *
30903934	30903858	15/10 M83723/60-110AN OR -110AC	83330118	18 - 36 VDC	1.0 +/-0.1 OHMS	9	NONE	EX-0106015	Cartridge, Power Device UN0276	1.4C *
30903935	30903857	15/10 M83723/60-110AN OR -110AC	83330118	18 - 36 VDC	1.0 +/-0.1 OHMS	9	NONE	EX-0106015	Cartridge, Power Device UN0276	1.4C *
30903936	30903859	15/10 M83723/60-18AN OR -18AC	83330118	18 - 36 VDC	1.0 +/-0.1 OHMS	10	NONE	EX-0106015	Cartridge, Power Device UN0276	1.4C *
30903937	30903871	15/10 M83723/60-114AN OR -114AC	83330764	18 - 36 VDC	1.0 +/-0.1 OHMS	6	NONE	EX-0106015	Cartridge, Power Device UN0276	1.4C *
30903938	30903872	15/10 M83723/60-114 AN	83330765	18 - 36 VDC	1.0 +/-0.1 OHMS	5	NONE	EX-0106015	Cartridge, Power Device UN0276	1.4C *

* Unit may be shipped as 1.4S, UN0323 with EX 2002030115, see paragraph 14

** Unit may be shipped as 1.4S, UN0323 with EX 0105187, see paragraph 14

*** Unit may be shipped as 1.4S, UN0323 with EX 0105188, see paragraph 14

**PACIFIC SCIENTIFIC
CARTRIDGE POWER DEVICE**

TABLE 1

P/N / SUBSTITUTE	SUGGESTED YRS	PROTECTIVE CAP or EQUIVALENT	SAFETY CHAMBER	OPERATING VOLTAGE	BRIDGEWIRE RESISTANCE	SEE FIG	COMPONENT EXEMPTION	AUTHORITY/ NAME	PROPER SHIPPING	UN NO.	CLASS	
30903938-1	30903872-1	15/10	M83723/60-114 AC	83330765	18 - 36 VDC	1.0 +/-0.1 OHMS	6	NONE	EX-0106015	Cartridge, Power Device	UN0276	1.4C *
30903939	30903874	15/10	M83723/60-110AN OR -110AC	83330118	18 - 36 VDC	1.0 +/-0.1 OHMS	9	NONE	EX-0106015	Cartridge, Power Device	UN0276	1.4C *
30903940	30903875	15/10	M83723/60-212AN OR-212 AC	83330764	18 - 36 VDC	1.0 +/-0.1 OHMS	12	NONE	EX-0106015	Cartridge, Power Device	UN0276	1.4C *
30903941	30903889	15/10	M83723/60-28AN OR -28AC	83330760	18 - 36 VDC	1.0 +/-0.1 OHMS	10	NONE	EX-0106015	Cartridge, Power Device	UN0276	1.4C *
30903942	30903890	15/10	M83723/60-18AN OR -18AC	83330759	18 - 36 VDC	1.0 +/-0.1 OHMS	10	NONE	EX-0106015	Cartridge, Power Device	UN0276	1.4C *
30903943	30903891	15/10	M83723/60-210AN OR-210 AC	83330760	18 - 36 VDC	1.0 +/-0.1 OHMS	14	NONE	EX-0106015	Cartridge, Power Device	UN0276	1.4C *
30903944	30903894	15/10	M83723/60-112AN OR -112AC	83330760	18 - 36 VDC	1.0 +/-0.1 OHMS	10	NONE	EX-0106015	Cartridge, Power Device	UN0276	1.4C *
30903945	30903895	15/10	M83723/60-112AN OR -112AC	83330760	18 - 36 VDC	1.0 +/-0.1 OHMS	10	NONE	EX-0106015	Cartridge, Power Device	UN0276	1.4C *
30903949	30903896	15/10	M83723/60-112AN OR -112AC	83330760	18 - 36 VDC	1.0 +/-0.1 OHMS	10	NONE	EX-0106015	Cartridge, Power Device	UN0276	1.4C *
30903951	30903801	15/10	M83723/60-10DA	83330118	18 - 36 VDC	1.0 +/-0.1 OHMS	2	NONE	EX-0106015	Cartridge, Power Device	UN0276	1.4C *
30903955	-	15/10	M838999/33	83330118	18 - 36 VDC	1.0 +/-0.1 OHMS	16	NONE	EX-0106015	Cartridge, Power Device	UN0276	1.4C *
30903956	-	15/10	M825043-10A	83330118	18 - 36 VDC	1.0 +/-0.1 OHMS	1	NONE	EX-0106015	Cartridge, Power Device	UN0276	1.4C *
30903959	30903876	15/10	M83723/60-212AN OR-212 AC	83330765	18 - 36 VDC	1.0 +/-0.1 OHMS	12	NONE	EX-0106015	Cartridge, Power Device	UN0276	1.4C *
30903962	-	15/10	M838999/33	83330118	18 - 36 VDC	1.0 +/-0.1 OHMS	17	NONE	EX-0106015	Cartridge, Power Device	UN0276	1.4C *
30903963	-	15/10	M838999/33	83330118	18 - 36 VDC	1.0 +/-0.1 OHMS	17	NONE	EX-0106015	Cartridge, Power Device	UN0276	1.4C *
30903963-1	-	15/10	M838999/33	83330118	18 - 36 VDC	1.0 +/-0.1 OHMS	17	NONE	EX-0106015	Cartridge, Power Device	UN0276	1.4C *
30903963-2	-	15/10	M838999/33	83330118	18 - 36 VDC	1.0 +/-0.1 OHMS	17	NONE	EX-0106015	Cartridge, Power Device	UN0276	1.4C *
30903964	30903870	15/10	M83181-8RA	83330118	18 - 36 VDC	1.0 +/-0.1 OHMS	11	NONE	EX-0106015	Cartridge, Power Device	UN0276	1.4C *
30903965	30903965	6	M821044C06 NUTS	83330118	18-30 VDC	1.5 +/- 0.25 OHMS	21	CA-861204	EX-8611120	Cartridge, Power Device	UN0323	1.4S

* Unit may be shipped as 1.4S, UN0323 with EX 2002030115. see paragraph 14
 ** Unit may be shipped as 1.4S, UN0323 with EX 0106187. see paragraph 14
 *** Unit may be shipped as 1.4S, UN0323 with EX 0106188. see paragraph 14

PACIFIC SCIENTIFIC
CARTRIDGE POWER DEVICE

TABLE 1

P/N / SUBSTITUTE	SUGGESTED YRS	PROTECTIVE CAP of EQUIVALENT	SAFETY CHAMBER	OPERATING VOLTAGE	BRIDGEWIRE RESISTANCE	SEE FIG	COMPONENT AUTHORITY/ EXEMPTION	PROPER SHIPPING NAME	UN NO.	CLASS
30903966	10	MS25043-10DA	N/A	UNIT USED FOR HERO TESTING		N/A	N/A	N/A	N/A	N/A
52000735-1	10	AE8372360-28RN	83390118	4 - 36 VDC	1.0 +/-0.1 OHMS	20	CA-850402	EX-8502243 Igniter's	UN0454	1.4S
63000399-1	10	M8372360-28AN	59000067	4 - 36 VDC	1.0 +/-0.1 OHMS	1	NONE	EX-9303236 Cutters, Cable, Explosive	UN0070	1.4S

* Unit may be shipped as 1.4S, UN0323 with EX 2002030115. see paragraph 14
 ** Unit may be shipped as 1.4S, UN0323 with EX 0105187. see paragraph 14
 *** Unit may be shipped as 1.4S, UN0323 with EX 0106188. see paragraph 14



U.S. Department
of Transportation

Research and
Special Programs
Administration

400 Seventh St., S.W.
Washington, D.C. 20590

The US Department of Transportation
Competent Authority for the United States

CLASSIFICATION OF EXPLOSIVES

Based upon a request by James V. Smallwood on behalf of Pacific Scientific/Energetic Materials Company, P.O. Box 5002, 7073 West Willis Drive, Chandler, Arizona, the following items are classed in accordance with Section 173.56, Title 49, Code of Federal Regulations (49 CFR). A copy of your application, all supporting documentation and a copy of this approval must be retained and made available to DOT upon request.

U.N. PROPER SHIPPING NAME AND NUMBER: Cartridges, power device, UN0276

U.N. CLASSIFICATION CODE: 1.4C

<u>REFERENCE NUMBER</u>	<u>PRODUCT DESIGNATION/PART NUMBER</u>
EX-0106015	(30903928), (30903934), (30903932), (30903937), (30903938), (30903938-1), (30903929), (30903930), (30903927), (30903931), (30903933), (30903935), (30903936), (30903939), (30903940), (30903959), (30903942), (30903943), (30903944), (30903945), (30903949), (30903921), (30903951), (30903845), (30903870), (30903886/C), (30903941), (30903898) (30903892), (30903899), (30903827-2), (30903955) (30903956), (30903962), (30903963), (30903827) (30903912), (30903856), (30903836), (30903871) (30903872), (30903872-1), (30903913), (30900000M) (30903822), (30903828), (30903852), (30903857) (30903859), (30903874), (30903875), (30903876) (30903890), (30903891), (30903894), (30903895) (30903896), (30903801), (30903964), (30903889) 2-102060-1, 2-102280-1, 2-102290-1, 2-102470-1 2-102480-1, 2-102490-1, 2-102500-1, 2-102510-1 2-102520-1, 2-102530-1, 2-102540-1, 2-102550-1 2-102560-1, 2-102570-1, 2-102580-1, 2-102590-1 2-102600-1, 2-102610-1, 2-102620-1, 2-102630-1 2-102640-1, 2-102650-1, 2-102660-1, 2-102670-1 2-102730-1, 2-102740-1, 2-102770-1, 2-102780-1 2-102790-1, 2-102800-1, 2-102810-1, 2-102820-1 2-102860-1, 2-102900-1, 2-102920-1, 2-102930-1 2-102960-1, 2-102280-2, 2-102290-2, 2-102470-2 2-102480-2, 2-102490-2, 2-102500-2, 2-102510-2 2-102520-2, 2-102530-2, 2-102540-2, 2-102550-2 2-102560-2, 2-102570-2, 2-102580-2, 2-102590-2 2-102600-2, 2-102610-2, 2-102620-2, 2-102630-2 2-102640-2, 2-102650-2, 2-102670-2, 2-102740-2 2-102740-3, 2-102780-2

Approved by:

Robert A. McGuire
Robert A. McGuire
Associate Administrator for
Hazardous Materials Safety

JUL 19 2001

(DATE)