

# M680E EcoMag Sustainable Magnalock®

*1,200 lbs holding force,  
bracket mounted,  
sustainable Magnalock*



The same unsurpassed intelligence, style and convenience as the previous M680 series, but with 80% reduction in energy consumption.

The M680E is intelligent, with built-in door prop sensing allowing the magnet to de-energize the coil when the door is held open for extended periods. The M680EBD offers built-in smart voltage sensing, integrated patented BondSTAT, tamper sensor as well as door position status monitoring. The aesthetics and design finishes of the EcoMag are refined enough for the most discriminating designer openings. It also offers the fastest, easiest, most secure installation of any bracket mount maglock with an updated strike plate mounting template. The optional integrated request to exit (REX) provides optimum coverage for detecting an approaching person so the door unlocks for egress.

## Features

### Standard Features

- Strike plate mounting template provides the easiest install for out-swing doors
- LED Indicator shows the lock is secure, open, or has an incomplete bond
- Wire chamber anti-tamper switch
- Tamper Switch sends an alarm output if the cover is removed and is selectable to NO or NC
- Available integrated BondSTAT and Door Position Switch
- Autosensing dual voltage with microprocessor technology
- Adjustable automatic relock timer (0 to 30 seconds)
- Energy efficient, low power usage
- Size optimized for use with door closers
- MagnaCare® lifetime replacement, no-fault, no questions asked warranty

### Optional Features

- **B** Integrated patented BondSTAT magnetic bond sensor
- **D** Integrated Door Position Switch (DPS)
- **X** Integrated passive infrared request to exit

### Accessories

- **ASB-680** Aluminum Shim Bracket in Clear or Black Anodized
- **CWB-680** Concrete Wood Bracket in Clear or Black Anodized
- **GDHB-680** Glass Door Header Bracket in Clear or Black Anodized

For easy 3D instructions, download the BILT mobile app



Grade 2



MagnaCare Warranty



Auto Sensing Dual Voltage 12/24



PoE Friendly



Fire Rated



Preload

# Specifications

## Certifications

- UL 10C Fire Rated, 1 Hour
- CAN/ULC-S104 Fire Door Conformant
- UL 1034 Burglary-Resistant Listed
- UL 294
- ANSI/BHMA A156.23, Grade 2; E18501 Compliant
- California State Fire Marshal Listed

## Electrical

- **Maglock Average Power Draw (±10%)**
  - 113 mA at 12 VDC
  - 52 mA at 24 VDC
- **Maglock Maximum Power Draw (±10%)**
  - 515 mA at 12 VDC
  - 290 mA at 24 VDC
- **REX Power (±10%)**
  - +25 mA at 12 VDC
  - +10 mA at 24 VDC

## Holding Force

- 1,200 lbs [544kg]

## Operating Temperature

- 32° to 110°F [0° to 43°C]
- Indoor use only

## Shipping Weight

- 8 lbs [3.6kg]

# Dimensions

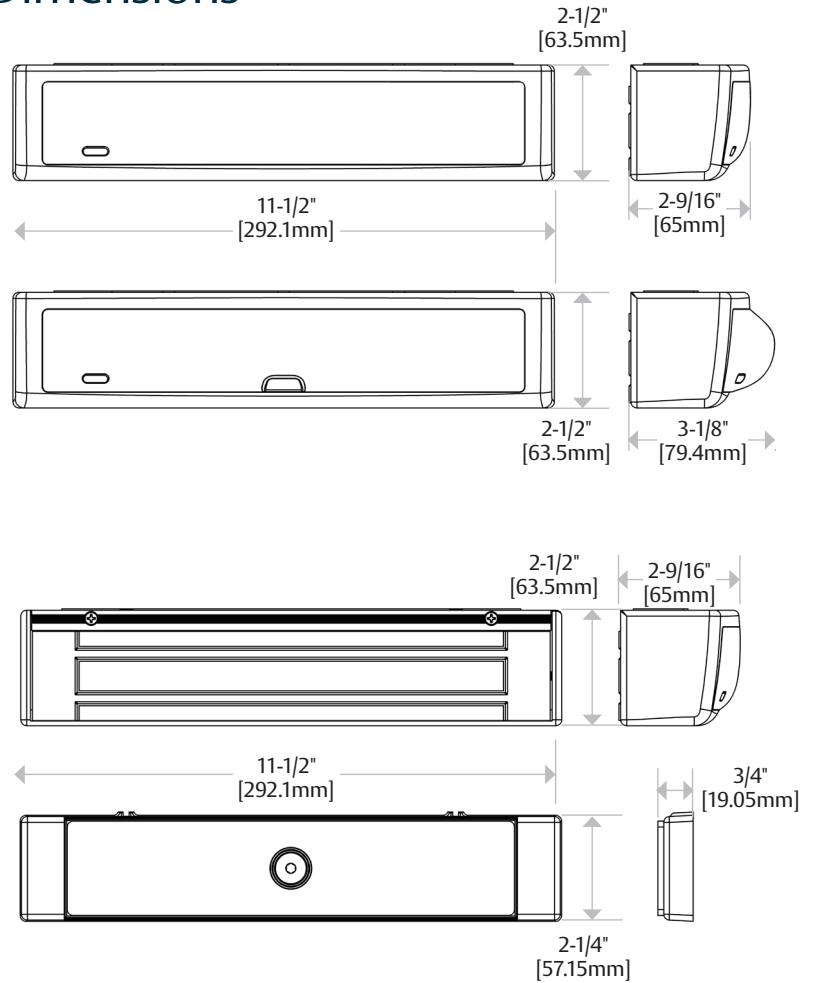

# Related Accessories



ASB-680

CWB-680

GDHB-680

Ordered Separately

# How to Order

MODEL SERIES	MONITORING OPTIONS	ACCESSORY OPTIONS	FINISH OPTIONS
<b>M680E</b>	<b>BD</b>	<b>X</b>	<b>- 606</b>
M680E 1,200 lbs	(blank) No Monitoring BD BondSTAT Monitor & Door Position Switch	(blank) No Accessory Options X PIR Request to Exit	628/US28 Satin Aluminum Clear 605/US3 Bright Brass 606/US4 Satin Brass 612/US10 Satin Bronze 613E Dark Oxidized Satin Bronze 629 Bright Stainless Steel 630 Satin Stainless Steel BSP Black Suede Powder