



# ND Series

## Grade 1 Cylindrical Locks

### OVERVIEW

Beyond Grade 1 performance is the hallmark of the mechanical and electrified ND Series locks. These locks are put through extreme levels of testing and are proven to withstand 3,100 in.-lb. of abusive lever torque—more than 2-1/2 times the Grade 1 standard requirement. Offset lever pull testing up to 1,600 lbs. assures you of the lock's superb resistance against pry bar attacks. More than strong, ND Series is built to last and shows nearly zero droop or wobble after 16 million cycles.

All ND Series locks including electronic functions, ligature-resistant trims, and ground-breaking, high-visibility status indication trims use the common cylindrical ANSI 161 door preparation making them easily interchangeable. They are ideal for all new construction and retrofit applications where Grade 1 strength and security are desired.



### FINISHES



605  
Bright Brass

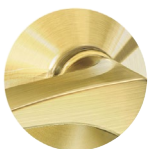

606  
Satin Brass



612  
Satin Bronze

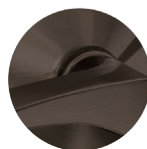

613  
Oil Rubbed  
Bronze

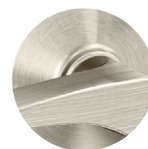

619  
Satin Nickel



622  
Matte Black



625  
Bright Chrome

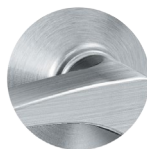

626  
Satin Chrome

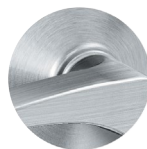

626AM  
Satin Chrome  
Antimicrobial

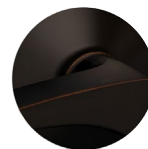

643e<sup>1</sup>  
Aged Bronze

1. e = an equivalent finish to the BHMA standard

## LEVER STYLES



**ATH (Athens)**  
8AT - Milled tactile warning



**BRK (Boardwalk)**  
8BK - Knurled tactile warning



**BRW (Broadway)**  
8BY - Knurled tactile warning

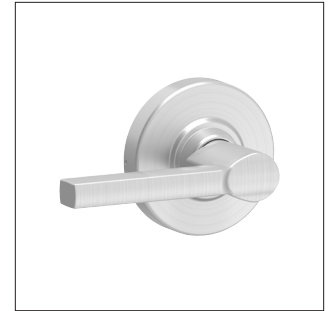

**LAT (Latitude)**  
8LT - Milled tactile warning



**LON (Longitude)**  
8LN - Milled tactile warning



**OME (Omega)**



**RHO (Rhodes)<sup>1</sup>**  
8RO - Milled tactile warning<sup>1</sup>



**SPA (Sparta)**  
8SP - Milled tactile warning



**TLR (Tubular)**  
8TR - Knurled tactile warning

### Dimensions

Lever	Width	Projection
ATH (Athens)	4.56"	3.31"
BRK (Boardwalk)	4.94"	3.06"
BRW (Broadway)	4.50"	3.06"
LAT (Latitude)	4.50"	3.13"
LON (Longitude)	4.94"	3.13"
OME (Omega)	5.06"	3.31"
RHO (Rhodes)	4.56"	2.94"
SPA (Sparta)	4.94"	3.50"
TLR (Tubular)	4.94"	3.00"

Rose	Diameter
Standard	3.44"

Return to door meets 1/2" requirement for Boardwalk (BRK), Longitude (LON), Omega (OME), Rhodes (RHO), Sparta (SPA) and Tubular (TLR) levers

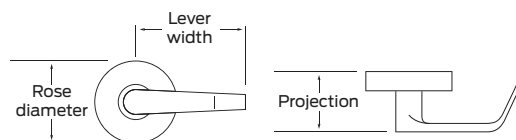

1. Optional break-away feature available on Rhodes levers for most locking functions. This allows the handheld part of the lever to break away from the shank when extreme torque is applied protecting the spring cage and locking mechanism from exterior access to help prevent unauthorized break-in.

## INDICATORS

### Inside Trim



### Outside Trim



Available Messages			
	Standard indicator messages		ND78/ND98 indicator message
	UNLOCKED	VACANT	UNLOCKED To lock, turn key 1:  then
	LOCKED	OCCUPIED	LOCKED 2:  then, 3: Remove key
Inside trim	IS-LOC	IS-OCC	IS-CRS
Outside trim	OS-LOC	OS-OCC	-
Inside trim (Française)	IS-LOCFR	IS-OCCFR	IS-CRSFR
Outside trim (Française)	OS-LOCFR	OS-OCCFR	-

Note: Spanish language options available via RFQ.

Indicator Dimensions		
Trim	Width	Projection
Escutcheon	3.66"	0.95"
Window (surface area)	1.92 square inches	0.22 square inches

## LIGATURE-RESISTANT SOLUTIONS



**HSLR**  
Handed

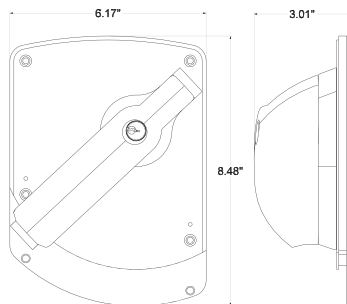

Dimensions			
	Width	Height	Projection
HSLR	6.17"	8.48"	3.01"

Specifications and certifications	
	HSLR
Accepted by NYS-OHM	•
ADA compliant	•
Suitable for:	
High risk areas	•
Medium risk areas	•
Low risk areas	•

## MECHANICAL LOCK FUNCTIONS

### Legend

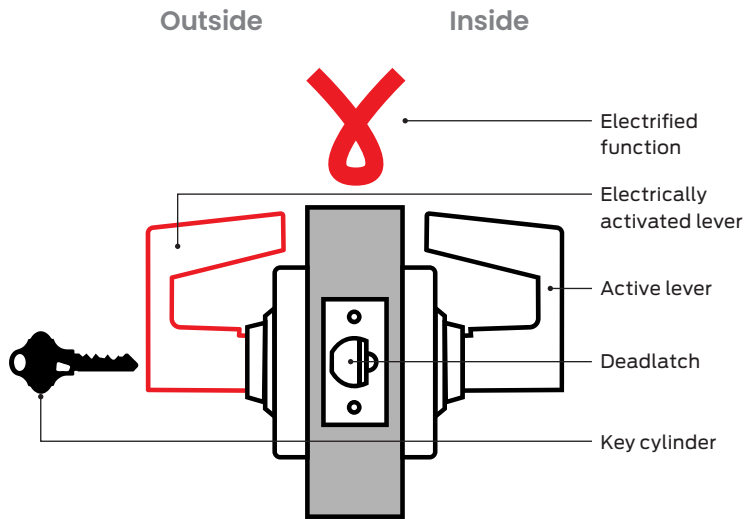

### Key

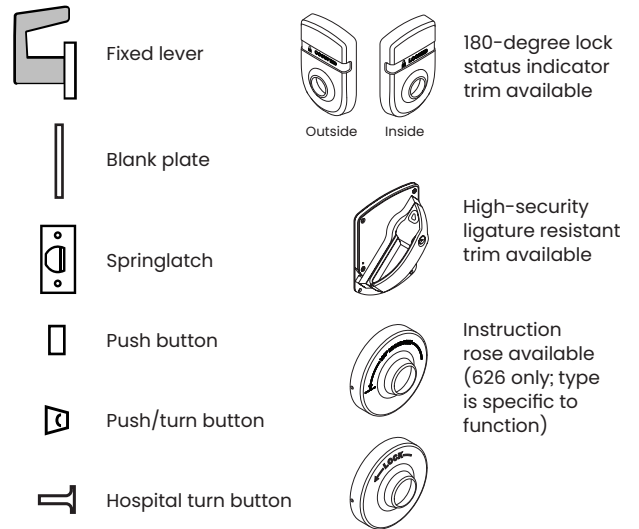

### Product Identification Guide

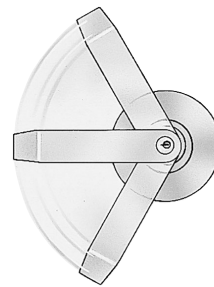
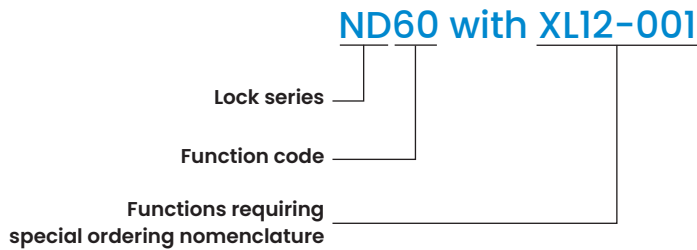

### Vandlgard® functions.

Some functions feature Vandlgard locked lever protection. It allows the outside lever to rotate freely up and down when locked to limit the ability of vandals to apply excessive force to the chassis helping to prevent damage to internal components.

## MECHANICAL NON-KEYED FUNCTIONS

**Schlage**  
**ND10**

**Passage latch**

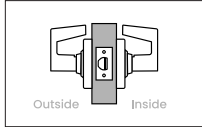

- Levers both sides; springlatch
- Latch retracted by lever from either side at all times
- Inside lever always free for immediate egress

To order configured with Request to Exit (RX), specify RX under special options.

**ANSI**  
**F75**

**Schlage**  
**ND12**

**Exit lock**

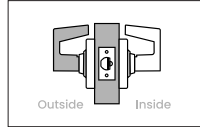

- Levers both sides; deadlatch
- Outside lever always fixed; latch retracted by inside lever
- Inside lever always free for immediate egress

To order configured with Request to Exit (RX), specify RX under special options.

**ANSI**  
**F89**

**Schlage**  
**ND25**

**Exit lock with exterior blank plate**

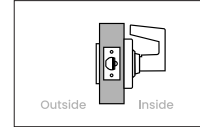

- Blank plate outside; lever inside; deadlatch
- Latch retracted by inside lever
- Inside lever always free for immediate egress

**ANSI**  
**-**

**Schlage**  
**ND30**

**Patio lock**

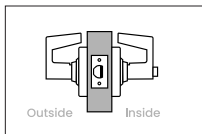

- Lever outside; push button in lever inside; springlatch
- In unlocked state latch is retracted by either lever
- Outside lever is made inoperative by pushing button on inside lever
- Rotating inside lever retracts latch and releases button unlocking outside lever; closing door also unlocks preventing lock-out
- Inside lever always free for immediate egress

**ANSI**  
**F77**

**Schlage**  
**ND40**

**Bath/bedroom privacy lock**

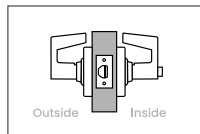

- Lever with emergency release recessed slot outside; push button in lever inside; springlatch
- In unlocked state latch is retracted by either lever
- Outside lever is made inoperative by pushing button on inside lever
- Rotating inside lever retracts latch and releases button unlocking outside lever; closing door also unlocks preventing lock-out
- Emergency unlock: an emergency key (sold separate) or small, flat screwdriver inserted in outside lever and turned releases button to unlock
- Inside lever always free for immediate egress

Note: Locks ordered with indicator trim fit 1-3/4" doors. Sold separate spacer kits allow application to doors 1-3/8" to 1-11/16".

To order an emergency key use part number 35-270.

**ANSI**  
**F76**

**Schlage**  
**ND44**

**Hospital privacy lock**

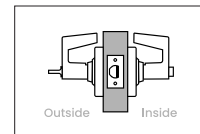

- Emergency turn in lever outside; push button in lever inside; springlatch
- In unlocked state latch is retracted by either lever
- Outside lever is made inoperative by pushing button on inside lever
- Rotating inside lever retracts latch and releases button unlocking outside lever; closing door also unlocks preventing lock-out
- Emergency unlock: rotating emergency turn in outside lever releases button to unlock
- Inside lever always free for immediate egress

Note: Locks ordered with indicator trim fit 1-3/4" doors. Sold separate spacer kits allow application to doors 1-3/8" to 1-11/16".

## MECHANICAL NON-KEYED FUNCTIONS

**Schlage**  
**ND45**

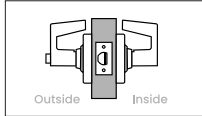

**Time out lock**  
**with Vandlgard®**

- Spring-loaded push button in lever outside; lever inside; springlatch
- In unlocked state latch is retracted by either lever
- Caretaker side: pushing and holding button enables Vandlgard® feature; detention side lever will rotate without engaging latch
- Releasing manually held button enables inside lever to re-engage with latch and open the door

ANSI

-

**Schlage**  
**ND170**



**Single dummy trim**

- Fixed lever one side only; no latch or chassis
- Used for door pull or matching inactive trim

ANSI

-

**Schlage**  
**ND172**

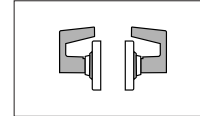

**Double dummy trim**

- Fixed levers—both sides; no latch or chassis
- Used for door pull or matching inactive trim

Note: Latch cover plates available. Order part number 47269199.

ANSI

-

## MECHANICAL KEYED FUNCTIONS

**Schlage**  
**ND25 x 70**

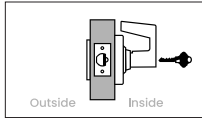

**ANSI**  
**F113**  
**Classroom exit lock**

- Blank plate outside; lever with cylinder inside; deadlatch
- In unlocked state latch is retracted by inside lever
- Outside always secure; inside lever is made inoperative by key inside
- Key inside retracts latch and unlocks inside lever

**Schlage**  
**ND25 x 80**

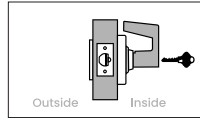

**ANSI**  
**F112**  
**Storeroom exit lock**

- Blank plate outside; lever with cylinder inside; deadlatch
- Outside always secure; inside lever is always fixed
- Key inside retracts latch but does not unlock lever

**Schlage**  
**ND50**

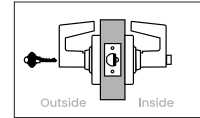

**ANSI**  
**F82**  
**Entrance/office lock**



- Lever with key cylinder outside; push button in lever inside; deadlatch
- In unlocked state latch is retracted by either lever
- Outside lever is made inoperative by pushing button on inside lever; key outside does not lock
- Key outside or rotating inside lever retracts latch and releases button unlocking outside lever
- Inside lever always free for immediate egress

Note: Locks ordered with indicator trim fit 1-3/4" doors. Sold separate spacer kits allow application to doors 1-3/8" to 1-11/16".

**Schlage**  
**ND53**

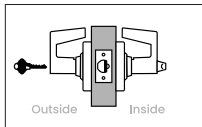

**ANSI**  
**F109**  
**Entrance lock**



- Lever with key cylinder outside; push/turn button in lever inside; deadlatch
- In unlocked state latch is retracted by either lever
- Outside lever is made inoperative by pushing button or pushing and turning button on inside lever; key outside does not lock
- **Pushed button unlocking:** key outside or rotating inside lever retracts latch and releases button unlocking outside lever
- **Pushed/turned button unlocking:** key outside or rotating inside lever retracts latch but does not unlock outside lever; rotate inside button to start position to allow button release and unlocking by key or by rotating inside lever
- Inside lever always free for immediate egress

Caution: Egress without fully releasing the push/turn button can result in lock-out situations.

Note: Locks ordered with indicator trim fit 1-3/4" doors. Sold separate spacer kits allow application to doors 1-3/8" to 1-11/16".

**Schlage**  
**ND60 with XN12-001**

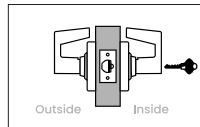

**ANSI**  
**-**  
**Vestibule lock with interior unlocking only**

- Lever outside; lever with key cylinder inside; deadlatch
- In unlocked state latch is retracted by either lever
- Outside lever is locked or unlocked by key inside
- Inside lever always free for immediate egress

To order, specify function and note XN12-001 as a special option.

**Schlage**  
**ND70**

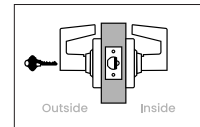

**ANSI**  
**F84**  
**Classroom lock, exterior lockdown only**



- Lever with key cylinder outside; lever inside; deadlatch
- In unlocked state latch is retracted by either lever
- Outside lever is locked or unlocked by key outside
- Inside lever always free for immediate egress

## MECHANICAL KEYED FUNCTIONS

**Schlage**  
**ND73**

**Corridor lock**

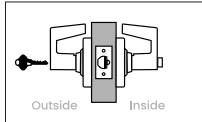

- Lever with key cylinder outside; push button in lever inside; deadlatch
- In unlocked state latch is retracted by either lever
- Outside lever is made inoperative by pushing button on inside lever or by key outside
- **When locked by pushed button:** rotating inside lever retracts latch and releases button unlocking outside lever; closing door also unlocks preventing lock-out
- **When locked by key:** rotating inside lever retracts latch but outside lever remains fixed until unlocked by key outside
- Inside lever always free for immediate egress

**ANSI**  
**F90**

**Schlage**  
**ND80**

**Storeroom lock**

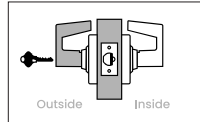

- Lever with key cylinder outside; lever inside; deadlatch
- Outside lever always fixed; latch retracted by inside lever
- Key in outside lever retracts latch only
- Inside lever always free for immediate egress

To order configured with Request to Exit (RX), specify RX under special options.

**ANSI**  
**F86**

**Schlage**  
**ND81**

**Accessible storeroom lock**

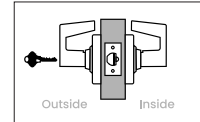

- Lever with key cylinder outside; lever inside; deadlatch
- Outside lever is always fixed when key is not present; latch retracted by inside lever
- Key outside turned counter-clockwise retracts latch; 180-degree clockwise rotation of key allows outside lever to retract latch
- Inside lever always free for immediate egress

To order configured with Request to Exit (RX), specify RX under special options.

**Schlage**  
**ND85**

**Faculty restroom lock**

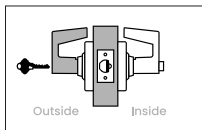

- Lever with conventional indicator cylinder outside; push button in lever inside; deadlatch
- Entrance by key only; outside lever always fixed; latch retracted by inside lever
- Push button on inside lever activates a locking pin that extends from the cylinder face to prohibit use of operating keys and indicate that the room is in use
- Turning inside lever or closing door releases the locking pin and push button to allow normal use of operating keys
- Emergency unlock: use of an emergency key (sold separate) is required to override the locking pin and unlock from the outside when push button is activated
- Inside lever always free for immediate egress

Note: Available with Conventional KIL indicator cylinder only. To order a spanner key to enable lockout feature use part number 35-251.

To order an emergency key use part number 35-102.

**ANSI**  
**F93**

**Schlage**  
**ND91**

**Vandgard® entrance/office lock**

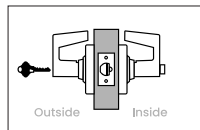

- Lever with key cylinder outside; push button in lever inside; deadlatch
- In unlocked state latch is retracted by either lever
- Outside is made inoperative by pushing button on inside lever; key outside does not lock, Vandgard® allows outside lever to rotate freely when locked
- Key outside or rotating inside lever retracts latch and releases button unlocking outside lever
- Inside lever always free for immediate egress

Note: Locks ordered with indicator trim fit 1-3/4" doors. Sold separate spacer kits allow application to doors 1-3/8" to 1-11/16".

**ANSI**  
**F82**

**Schlage**  
**ND92**

**Vandgard® entrance lock**

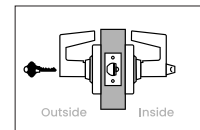

- Lever with key cylinder outside; push/turn button in lever inside; deadlatch
- In unlocked state latch is retracted by either lever
- Outside lever is made inoperative by pushing button or pushing and turning button on inside lever; key outside does not lock, Vandgard® allows outside lever to rotate freely when locked
- **Pushed button unlocking:** key outside or rotating inside lever retracts latch and releases button unlocking outside lever
- **Pushed/turned button unlocking:** key outside or rotating inside lever retracts latch but does not unlock outside lever; rotate inside button to start position to allow button release and unlocking by key or by rotating inside lever
- Inside lever always free for immediate egress

Caution: Egress without fully releasing the push/turn button can result in lock-out situations.

Note: Locks ordered with indicator trim fit 1-3/4" doors. Sold separate spacer kits allow application to doors 1-3/8" to 1-11/16".



## MECHANICAL KEYED FUNCTIONS

### Schlage ND94

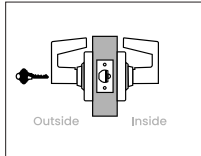

#### Vandlgard® classroom lock, exterior lockdown only



- Lever with key cylinder outside; lever inside; deadlatch
- In unlocked state latch is retracted by either lever
- Outside lever is locked or unlocked by key outside; Vandlgard® allows outside lever to rotate freely when locked
- Inside lever always free for immediate egress

### ANSI F84

### Schlage ND96

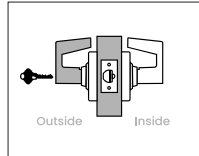

#### Vandlgard® storeroom lock



- Lever with key cylinder outside; lever inside; deadlatch
- Outside lever always inoperative; Vandlgard® allows outside lever to rotate freely when locked
- Key in outside lever retracts latch only
- Inside lever always free for immediate egress

To order configured with Request to Exit (RX), specify RX under special options.

### ANSI F86

### Schlage ND97

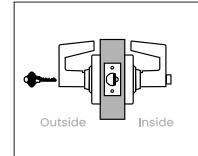

#### Vandlgard® corridor lock



- Lever with key cylinder outside; push button in lever inside; deadlatch
- In unlocked state latch is retracted by either lever
- Outside lever is made inoperative by pushing button on inside lever or by key outside; Vandlgard® allows outside lever to rotate freely when locked
- **When locked by pushed button:** rotating inside lever retracts latch and releases button unlocking outside lever; closing door also unlocks preventing lock-out
- **When locked by key:** rotating inside lever retracts latch but outside lever remains fixed until unlocked by key outside
- Inside lever always free for immediate egress

### ANSI F90

## MECHANICAL KEYED, DOUBLE CYLINDER FUNCTIONS

**Schlage**  
**ND60**

**Vestibule lock**

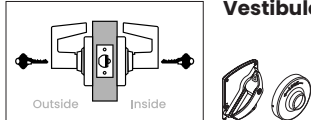

- Lever with key cylinder both sides; deadlatch
- In unlocked state latch is retracted by either lever
- Outside lever is made inoperative by key inside; key outside does not lock
- Key outside retracts latch but cannot unlock outside lever; only key inside unlocks
- Inside lever always free for immediate egress

Note: Available with optional instruction rose identifying key rotation direction for rapid lockdown. 626 finish only.

To order with instruction rose specify function and note XN12-035 as a special option.

**ANSI**  
**F88**

**Schlage**  
**ND66**

**Store lock**

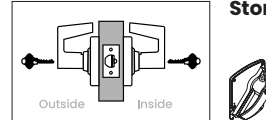

- Lever with key cylinder both sides; deadlatch
- In unlocked state latch is retracted by either lever
- Key in either lever locks or unlocks both levers

Caution: Double cylinder locks on any door, in any structure which is used for egress are a life safety hazard in times of emergency and their use is not recommended. Installation should be in accordance with existing codes only.

**ANSI**  
**F91**

**Schlage**  
**ND70 x 80**

**Classroom by storeroom lock**

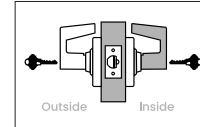

- Lever with key cylinder both sides; deadlatch
- In unlocked state inside lever is always fixed; latch retracted by outside lever
- Outside lever is locked or unlocked by key outside; key inside retracts latch but does not unlock either lever

Caution: Double cylinder locks on any door, in any structure which is used for egress are a life safety hazard in times of emergency and their use is not recommended. Installation should be in accordance with existing codes only

**ANSI**  
**-**

**Schlage**  
**ND72 with XN12-002**

**Communicating lock**

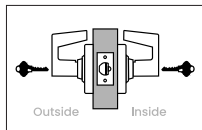

- Lever with key cylinder both sides; deadlatch
- In unlocked state latch is retracted by either lever
- Key in either lever makes inoperative only that lever
- Key in either lever retracts the latch and unlocks only that lever

Caution: Double cylinder locks on any door, in any structure which is used for egress are a life safety hazard in times of emergency and their use is not recommended. Installation should be in accordance with existing codes only.

To order, specify function and note XN12-002 as a special option.

**ANSI**  
**F80**

**Schlage**  
**ND72 with XN12-003**

**Vandlgard® communicating lock**

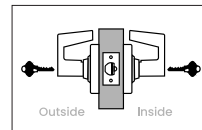

- Lever with key cylinder both sides; deadlatch
- In unlocked state latch is retracted by either lever
- Key in either lever makes inoperative only that lever; Vandlgard® allows locked lever to rotate freely when locked
- Key in either lever retracts the latch and unlocks only that lever

Caution: Double cylinder locks on any door, in any structure which is used for egress are a life safety hazard in times of emergency and their use is not recommended. Installation should be in accordance with existing codes only.

To order, specify function and note XN12-003 as a special option.

**ANSI**  
**F80**

**Schlage**  
**ND78**

**Classroom security lock (180-degree lockdown)**

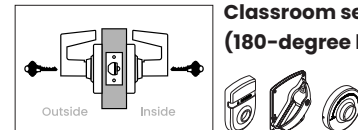

- Lever with key cylinder both sides; deadlatch
- In unlocked state latch is retracted by either lever
- Outside lever is made inoperative by rotating key in either lever 180 degrees counter-clockwise and returning to start position
- Unlock outside lever by rotating key 180 degrees clockwise in either lever and returning to start position
- Inside lever always free for immediate egress

Locks ordered in 626 finish come standard with instruction rose (47342586) identifying key rotation direction for rapid lockdown. Other finishes receive a standard rose.

Note: Locks ordered with indicator trim fit 1-3/4" doors. Sold separate spacer kits allow application to doors 1-3/8" to 1-11/16".

**ANSI**  
**F110**

## MECHANICAL KEYED, DOUBLE CYLINDER FUNCTIONS

### Schlage ND82

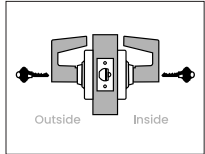

#### Institution lock



- Lever with key cylinder both sides; deadlatch
- Both levers are always fixed
- Key in either lever retracts latch only

Caution: Double cylinder locks on any door, in any structure which is used for egress are a life safety hazard in times of emergency and their use is not recommended. Installation should be in accordance with existing codes only.

### ANSI F87

### Schlage ND93

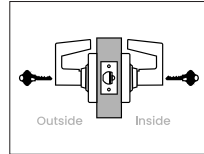

#### Vandlgard® vestibule lock



- Lever with key cylinder both sides; deadlatch
- In unlocked state latch is retracted by either lever
- Outside lever is made inoperative by key inside; key outside does not lock; Vandlgard® allows outside lever to rotate freely when locked
- Key outside retracts latch but cannot unlock outside lever; only key inside unlocks
- Inside lever always free for immediate egress

Note: Available with optional instruction rose identifying key rotation direction for rapid lockdown. 626 finish only.

To order with instruction rose specify function and note XN12-035 as a special option.

### ANSI F88

### Schlage ND98

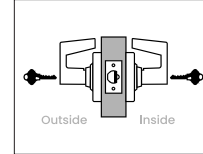

#### Vandlgard® classroom security lock (180-degree lockdown)

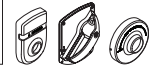

- Lever with key cylinder both sides; deadlatch
- In unlocked state latch is retracted by either lever
- Outside lever is made inoperative by rotating key in either lever 180 degrees counter-clockwise and returning to start position; Vandlgard® allows outside lever to rotate freely when locked
- Unlock outside lever by rotating key 180 degrees clockwise in either lever and returning to start position
- Inside lever always free for immediate egress

Locks ordered in 626 finish come standard with instruction rose (47342586) identifying key rotation direction for rapid lockdown. Other finishes receive a standard rose.

Note: Locks ordered with indicator trim fit 1-3/4" doors. Sold separate spacer kits allow application to doors 1-3/8" to 1-11/16".

### ANSI F110

## WIRED ELECTRIFIED FUNCTIONS

**Schlage**  
**ND12EL**

ANSI -

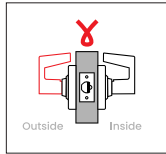

**Exit lock, electrically locked outside lever (fail safe)**



- Lever both sides; deadlatch
- Powered state: outside lever continuously locked (when in EL mode)
- When power is removed (via switch or power failure), in EL mode either lever will retract latch
- Inside lever always free for immediate egress

Note: Auto detects 12 or 24V DC. Chassis mounted switch allows field selectable EL/EU setting.

Ordering: Unless EL or EU is specified, order will default to an EU setting. Optional RX function can be ordered configured by specifying RX under special options or add later using kit part NI23-062.

**Schlage**  
**ND12EU**

ANSI -

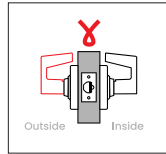

**Exit lock, electrically unlocked outside lever (fail secure)**



- Lever both sides; deadlatch
- Powered state: outside lever continuously unlocked (when in EU mode)
- When power is removed (via switch or power failure), in EU mode outside lever is locked
- Inside lever always free for immediate egress

Note: Auto detects 12 or 24V DC. Chassis mounted switch allows field selectable EL/EU setting.

To order configured with Request to Exit (RX), specify RX under special options.

**Schlage**  
**ND80EL**

ANSI -

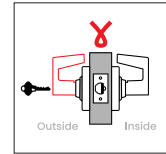

**Storeroom lock, electrically locked outside lever (fail safe)**



- Lever with key cylinder outside; lever inside; deadlatch
- Powered state: outside lever continuously locked (when in EL mode)
- When power is removed (via switch or power failure), in EL mode either lever will retract latch
- Key outside retracts latch but cannot change the normal locked or unlocked state of the outside lever
- Inside lever always free for immediate egress

Note: Auto detects 12 or 24V DC. Chassis mounted switch allows field selectable EL/EU setting.

Ordering: unless EL or EU is specified, order will default to an EU setting. Optional RX function can be ordered configured by specifying RX under special options or add later using kit part NI23-062.

**Schlage**  
**ND80EU**

ANSI -

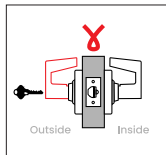

**Storeroom lock, electrically unlocked outside lever (fail secure)**



- Lever with key cylinder outside; lever inside; deadlatch
- Powered state: outside lever continuously unlocked (when in EU mode)
- When power is removed (via switch or power failure), in EU mode outside lever is locked
- Key outside retracts latch but cannot change the normal locked or unlocked state of the outside lever
- Inside lever always free for immediate egress

Note: Auto detects 12 or 24V DC. Chassis mounted switch allows field selectable EL/EU setting.

To order configured with Request to Exit (RX), specify RX under special options.

**Schlage**  
**ND96EL**

ANSI -

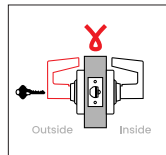

**Vandlgard® storeroom lock, electrically locked outside lever (fail safe)**



- Lever with key cylinder outside; lever inside; deadlatch
- Powered state: outside lever continuously locked (when in EL mode)
- Vandlgard® feature allows outside lever, when locked, to rotate without engaging latch
- When power is removed (via switch or power failure), in EL mode either lever will retract latch
- Key outside retracts latch but cannot change the normal locked or unlocked state of the outside lever
- Inside lever always free for immediate egress

Note: Auto detects 12 or 24V DC. Chassis mounted switch allows field selectable EL/EU setting.

Ordering: unless EL or EU is specified, order will default to an EU setting. Optional RX function can be ordered configured by specifying RX under special options or add later using kit part NI23-062.

**Schlage**  
**ND96EU**

ANSI -

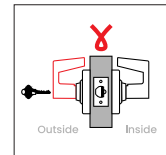

**Vandlgard® storeroom lock, electrically unlocked outside lever (fail secure)**



- Lever with key cylinder outside; lever inside; deadlatch
- Powered state: outside lever continuously unlocked (when in EU mode)
- When power is removed (via switch or power failure), in EU mode outside lever is locked
- Vandlgard® feature allows outside lever, when locked, to rotate without engaging latch
- Key outside retracts latch but cannot change the normal locked or unlocked state of the outside lever
- Inside lever always free for immediate egress

Note: Auto detects 12 or 24V DC. Chassis mounted switch allows field selectable EL/EU setting.

To order configured with Request to Exit (RX), specify RX under special options.

## CYLINDERS

Conventional cylinder	
P	6-pin Conventional (keyed 5)
P6	6-pin Conventional (standard)
Z	SL 7-pin Conventional (A2 pinning)
L	Less Conventional
C	Less 6-pin Conventional double cylinder

Full size interchangeable core (FSIC)	
R	6-pin FSIC
M	SL 7-pin FSIC (A2 pinning)
J	Less FSIC
T	Refundable FSIC construction core

Small format interchangeable core (SFIC)	
G	7-pin SFIC (A2 pinning)
B	Less SFIC
BDC	Disposable SFIC construction core
H	Refundable SFIC construction core

## SPECIFICATIONS

Chassis	
Material	Modular design of zinc and steel components plated for corrosion protection
Door thickness	<b>Standard:</b> 1-5/8" (41 mm) to 2-1/8" (54 mm) <b>Optional:</b> 1-3/8" (35 mm) - 6" (152 mm) EE, EO, EI, ED configurations
Handing	Non-handed
Trim	
Levers	<b>Standard:</b> Pressure cast zinc, plated to match product finish specification in nine designs - Athens (ATH), Boardwalk (BRK), Broadway (BRW), Latitude (LAT), Longitude (LON), Omega (OME), Rhodes (RHO), Sparta (SPA), and Tubular (TLR) <b>Optional:</b> Tactile feature available on all designs, specify 8AT, 8RO, 8SP, 8TR, 8LT, 8LN, 8OM, 8BY, or 8BK
Rose/escutcheon	Wrought brass or zinc, plated to match product finish specification
Finishes	<b>Nine available:</b> 605, 606, 612, 613, 619, 622, 625, 626, 643e; optional antimicrobial coating is available on 626—order as 626AM
Latch	
Backset	<b>Standard:</b> 2-3/4" (70 mm) <b>Optional:</b> 2-3/8", 3-3/4", 5" (60, 92, 127 mm)
Latch bolt	<b>Standard:</b> 1/2" (12 mm) throw spring latch or deadlatch (Stainless Steel) <b>Optional:</b> 3/4" (19 mm) throw anti-friction deadlatch available for pairs of doors
Strike	<b>Standard:</b> ANSI curved lip: 1-1/4" x 4-7/8" x 1-3/16" (32 mm x 124 mm x 30 mm) <b>Optional:</b> T Strike, ANSI strikes with alternative lip lengths, dust box options
Keying	
Formats	<b>Standard:</b> 6-pin Conventional cylinder with two patented keys <b>Optional:</b> FSIC, SFIC, and 7-pin SL cylinder formats plus less cylinder options made to fit non-Schlage cylinders from Best, Corbin Russwin, Medeco, Sargent and Yale
Access security	<b>Standard:</b> 6-pin, patented Everest 29 S123 keyway <b>Optional:</b> Open, restricted, Primus®, master keying, and construction keying
Wired electrified	
Input voltage	Autodetecting 12-24V DC, +/- 10%
Operating mode	Fail safe or fail secure via switch on chassis
Current draw	0.23 amps maximum; 0.01 amps holding
Request to Exit	Modular - 3A @ 125VAC / 2A @ 30VDC
Warranty	
	10 years mechanical, 1 year wired electrified
Certifications	
ANSI/BHMA	All ND Series comply with A156.2-2011, Series 4000 Grade 1 cylindrical locks; Wired electrified complies with A156.25 (indoor)
ICC	Complies with ICC A117.1 Accessible and Usable Buildings and Facilities
UL/cUL	UL 10C and CAN/ULC-S104; All locks 3-hour A label single fire door 4'0" x 10'0"; pair doors 3-hour fire door 8'0" x 8'0" with 3/4" latch option; pair doors 90-minute fire 8'0" x 10'0" with 3/4" latch option
CA Fire Code	All levers with a return to door of 1/2" (13 mm) or less comply (Rhodes, Sparta, Tubular, Omega, Longitude and Boardwalk)
FL Building Code	Complies with Florida Building Code (ASTM E330, E1886, E1996) and Miami Dade (TAS 201, 202, 203) requirements for hurricanes
Federal	Meets FF-H-106C Series 161 BAA compliant, all functions