

EXPLODED VIEW OF INTERNAL LOCK COMPONENTS



**TECH SUPPORT:**  
1-800-ALA-LOCK

ALARM LOCK SYSTEMS, INC.  
is a division of the  
**NAPCO Security Group**  
345 Bayview Avenue  
Amityville, New York 11701  
631-789-4871  
1-800-252-5625  
Fax: 631-789-3383  
For Sales and Repairs:  
1-800-ALA-LOCK  
For Technical Service:  
1-800-645-9440  
or visit us at  
<http://tech.napcosecurity.com/>  
(Note: Technical Service is for security professionals only)  
Publicly traded on NASDAQ Symbol: NSSC  
© ALARM LOCK 2016

Part No. WI1163E 08/16

# CYLINDER ADAPTER KITS:

To replace a specific cylinder, a specific *Cylinder Adapter Kit* is required. The kit includes: Cylinder Collars, Cylinder Adapter, IC or Standard Tailpiece, Plastic Rings, mounting screws and washer. **It does NOT include the cylinder.**

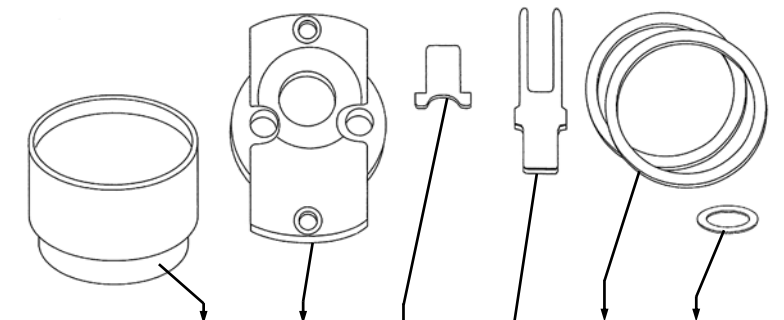

**Note:** When ordering kit, specify finish at end of Part #:  
Example: ET-ARIC/US3

**ATTENTION:** WHEN INSTALLING THE ADAPTER KIT, BE SURE TO REPLACE THE ORIGINAL TAILPIECE WITH THE TAILPIECE INCLUDED IN THE KIT.

Kit Description	Part #	Cylinder Collar(s)	Cylinder Adapter	Tailpiece		Plastic Rings	Washer
				Std	IC		
Arrow 6 & 7 pin I.C.	ET-ARIC	HW1098 HW1077	HW1066	--	HW1062	HW1099	--
Arrow Standard	ET-AR	HW980	HW1066	HW1053	--	HW1099	--
Assa Standard	ET-AS	HW980	HW1069	HW1054	--	HW1099	--
Alarm Lock Standard	ET-AL	HW980	HW1007	HW971	--	HW573	--
BEST 6 & 7 PIN I.C.	ET-BIC	HW1098 HW1077	HW1065	--	HW1062	HW1099	--
Corbin I.C.	ET-CIC	HW980	HW1067	--	HW1061	HW1099	--
Corbin Standard	ET-C	HW1077	HW1067	HW1055	--	--	--
Medico 6 & 7 Pin I.C.	ET-MIC	HW1051	HW1063	--	HW971	HW1099	WA171
Medico Standard	ET-M	HW1051	HW1069	HW1056	--	HW1099	--
Sargent I.C.	ET-RIC	HW1051	HW1066	--	HW1080	HW1099	--
Sargent Standard	ET-R	HW980	HW1066	HW971	--	HW1099	--
Schlage I.C.	ET-SIC	HW1098	HW1063	--	HW1060 (see image at left)	HW1099	HW830
Schlage Standard	ET-S	HW980	HW1007	HW1057	--	--	--
Yale 6 & 7 Pin I.C.	ET-YIC	HW1098 HW1151	HW1063	--	HW1059	HW573	WA160
Yale Standard	ET-Y	HW1077	HW1063	HW1058	--	--	--



## TO REPLACE THE CYLINDER ADAPTER:

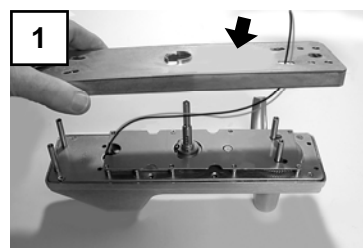

1 Remove Frame Spacer.

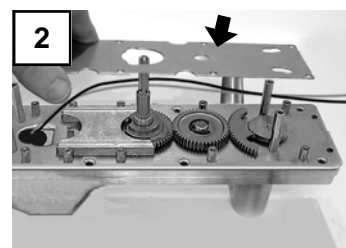

2 Remove Cover Plate.

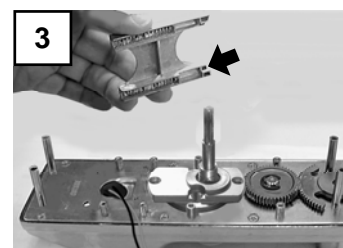

3 Remove Slide Plate (do not misplace the 2 springs).

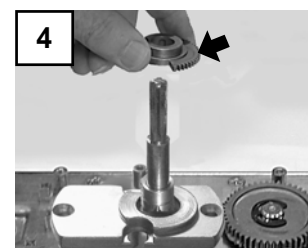

4 Remove Cylinder Gear Section.

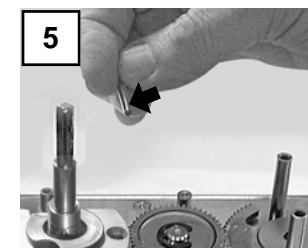

5 Remove Engage Pin from Spindle Bushing.

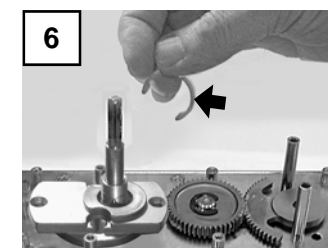

6 Remove Retainer Ring from Spindle Bushing.

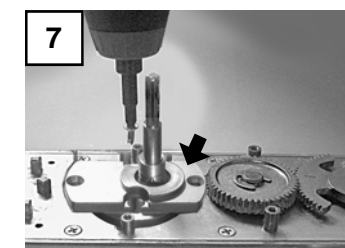

7 Remove Cylinder Adapter.

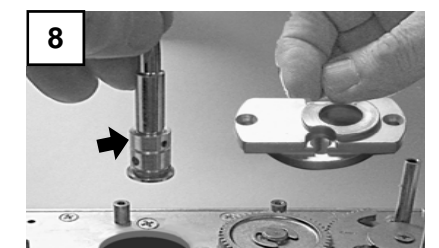

8 With Cylinder Adapter removed, remove Spindle Bushing.

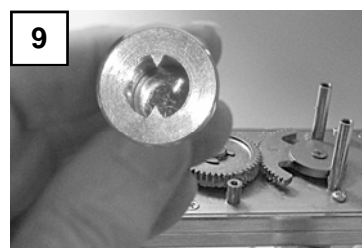

9 Note position on Spindle Bushing of 2 points (top and bottom) to accept tailpiece.

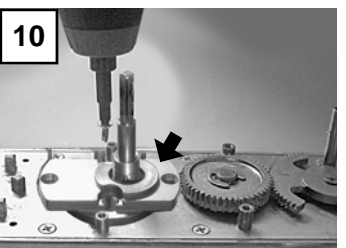

10 Replace old Cylinder Adapter with new Cylinder Adapter.

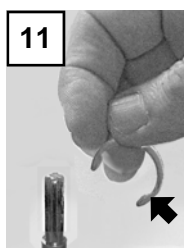

11 Replace Retainer Ring.

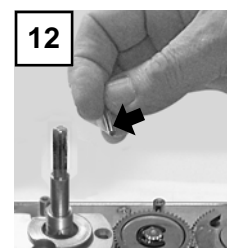

12 Replace Engage Pin on Spindle Bushing.

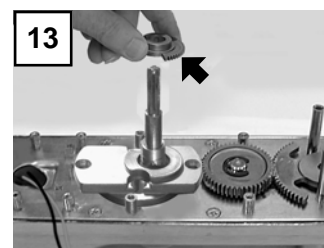

13 Replace Cylinder Gear Section. Be sure to align with Slide Plate.



14 Insert new cylinder and fasten with existing screws.

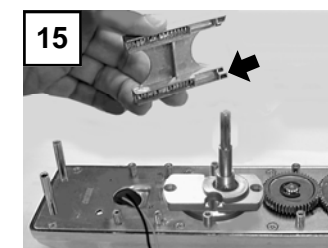

15 Replace Slide Plate (careful not to lose the 2 springs).

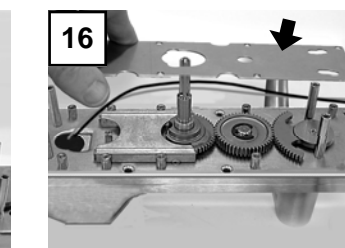

16 Replace Cover Plate.

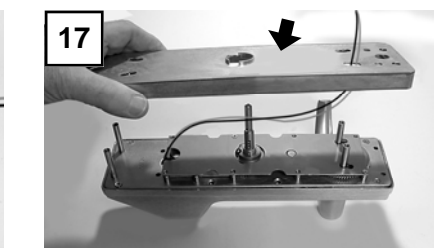

17 Replace Frame Spacer.