

Note: The product images shown may change over time as products are updated.

Dimensions

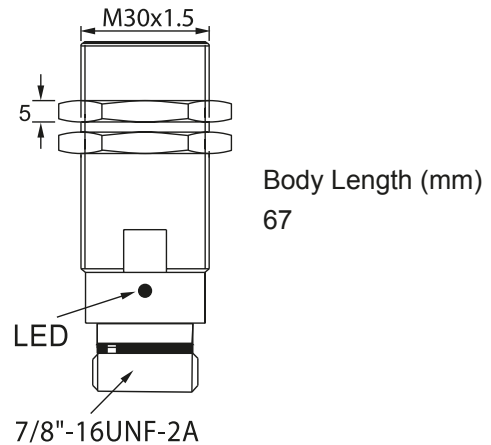

Part Number

WCN1-3015U-AZL3-PTFE-100CY-2

Features

Inductive Proximity Sensors are used in a wide variety of manufacturing operations where a metal target needs to be sensed. HTM Sensors inductive proximity sensors have a Lifetime Warranty, a CSA or UL approval, and a huge inventory for same-day shipping. For tougher applications where the sensors need more range to stay out of harm's way, or to withstand high temperatures, weld spatter, chemical exposure, oil or other rough environments, HTM Sensors has the widest range of proximity sensors on the market.

Connection

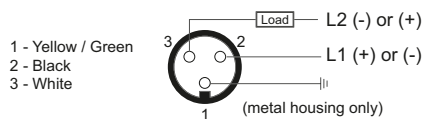

Technical Data

|                            |  |
|----------------------------|--|
| Body Style                 | Cylindrical                            |
| Sensor Housing Material    | SpatterGuard™ coated Brass             |
| Sensor Face Material       | PBT Plastic                            |
| Mounting Style             | Shielded                               |
| Diameter                   | 30 mm Threaded                         |
| Sensing Range:             | 15 mm Range                            |
| Output Type:               | AC/DC Output                           |
| Output Function            | Normally Open Output                   |
| Connection                 | 3-Pin Connector                        |
| Connector Type             | Mini Quick-Connect                     |
| Operating Voltage          | 20-250 VAC, 50-60HZ; 20-250 VDC        |
| Switching Frequency        | 25 Hz AC; 40 Hz DC                     |
| Operating Temperature      | -20 °C - +100 °C                       |
| Current Consumption        | <2.5mA                                 |
| IP Rating:                 | IP67                                   |
| EMC Rating                 | RFI>3V/m / EFT>1kV / ESD>4Kv (contact) |
| Shock Rating:              | IEC 60497-5-2 Part 7.4.1&7.4.2         |
| Short Circuit Protected    | Yes                                    |
| Reverse Polarity Protected | NO                                     |
| Max Current                | 200 mA                                 |
| Leakage Current            | <2.5mA                                 |
| Surge Current              | 2.2 A for 20 ms                        |
| Response Time              | 10 ms/10 ms                            |
| Hysteresis                 | <15%(Sr)                               |
| Overload Trip Point        | -                                      |
| Weld Field Immune          | Yes                                    |
| Weld Spatter Resistant     | Yes - SpatterGuard™ Coated             |
| Body Length (mm)           | 67                                     |



In the USA: 1889 Maryland Ave., Niagara Falls, NY 14305  
 In Canada: 3419 Mainway, Burlington, ON L7M 1A9  
 Toll Free: 1-800-644-1756 • Fax: 888-283-2127  
 service@htmsensors.com