



Note: The product images shown may change over time as products are updated.

Part Number

WCN1-1805A-B3S2-PTFE-100C

Features

Inductive Proximity Sensors are used in a wide variety of manufacturing operations where a metal target needs to be sensed. HTM Sensors inductive proximity sensors have a Lifetime Warranty, a CSA or UL approval, and a huge inventory for same-day shipping. For tougher applications where the sensors need more range to stay out of harm's way, or to withstand high temperatures, weld spatter, chemical exposure, oil or other rough environments, HTM Sensors has the widest range of proximity sensors on the market.

Connection

Normally Closed



Dimensions

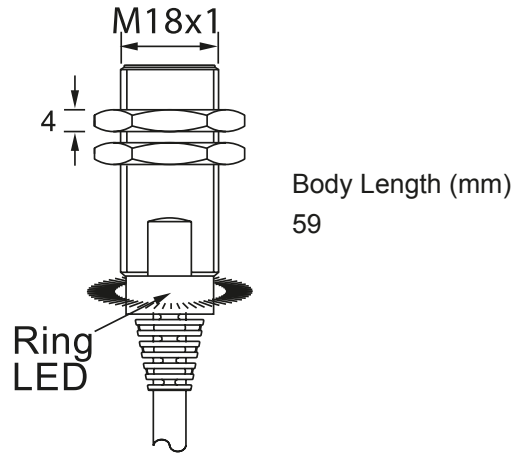

Technical Data

Body Style	Cylindrical
Sensor Housing Material	SpatterGuard™ coated Brass
Sensor Face Material	PBT Plastic
Mounting Style	Shielded
Diameter	18 mm Threaded
Sensing Range:	5 mm Range
Output Type:	AC Output
Output Function	Normally Closed Output
Connection	Pre-Three Wired Cable Connect
Connector Type	Cable
Operating Voltage	20-250 VAC
Switching Frequency	<25 Hz
Operating Temperature	-20 °C - +100 °C
Current Consumption	<1.8 mA
IP Rating:	IP67
EMC Rating	RFI>3V/m / EFT>1kV / ESD>4Kv (contact)
Shock Rating:	IEC 60497-5-2 Part 7.4.1&7.4.2
Short Circuit Protected	NO
Reverse Polarity Protected	NO
Max Current	400 mA
Leakage Current	<1.8 mA
Surge Current	5 A (20 ms)
Response Time	10 ms/10 ms
Hysteresis	<15%(Sr)
Overload Trip Point	-
Weld Field Immune	Yes
Weld Spatter Resistant	Yes - SpatterGuard™ Coated
Body Length (mm)	59



In the USA: 1889 Maryland Ave., Niagara Falls, NY 14305
 In Canada: 3419 Mainway, Burlington, ON L7M 1A9
 Toll Free: 1-800-644-1756 • Fax: 888-283-2127
 service@htmsensors.com