

Note: The product images shown may change over time as products are updated.

Diagram

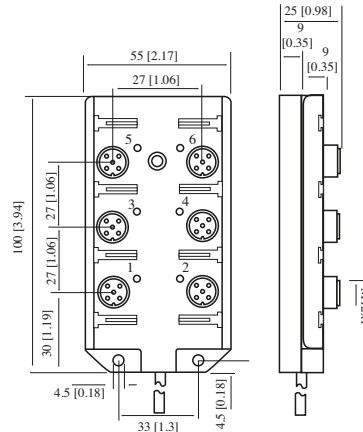

Part Number

DSTR6-5/4PA-2105

Features

4, 6 or 8 port distribution blocks make sensor connections easy and fast. Available in single occupancy ports or double occupancy ports for use with splitter cables to connect 2 sensors to each port. Available in 12-pin or 19-pin connectors or with a 5 m or 10 m prewired cable.

For additional information, contact HTM Sensors at 800-644-1756 or service@htmsensors.com

Wiring

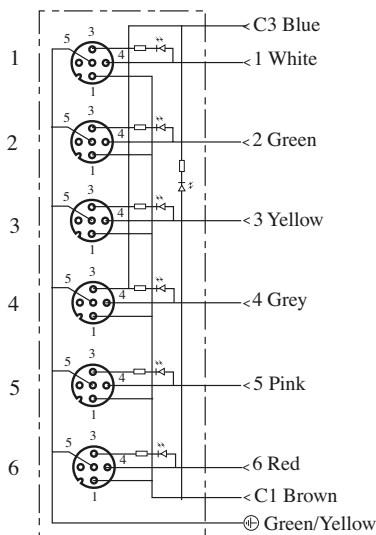

Technical Data

Number of Ports	6
Port Size	M12 A Coded
Port Location	Top
LED Circuit	PNP
Home Run Connection	Pre-wired
Home Run Location	Side
Length	5 m
Jacket Type	PVC
Rated Voltage	10-30V DC
Rated Current	4 Amp Max per Port / 12 Amps Max per Block
IP Rating	IP67
Operating Temperature	-15 C to + 90 C
Vibration Rating	IEC-68-2-6
Shock Rating	IEC-68-27
Housing Material	Nylon 6/6
O-Ring	Viton
Contact Carrier	PUR
Home Run Connector Body	-

