

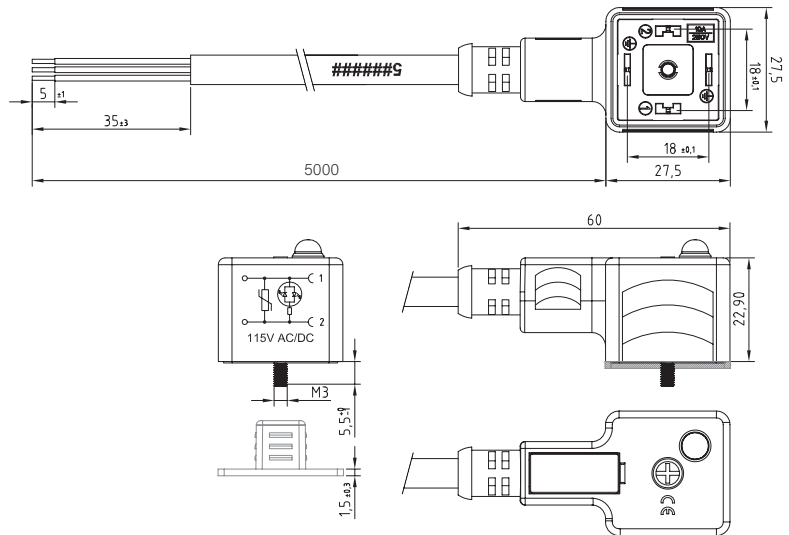

Note: The product images shown may change over time as products are updated.

Diagram



Part Number

V-AFA2V/R2C-V535

Features

HTM Sensors stocks thousands of sensor cables for convenient same-day-shipping. Standard M8 and M12 cables have the best prices in the industry and are always available and in stock for customer requirements.

New advances in sensor cables allow for extended durability and longevity in the harshest environments.

Wiring

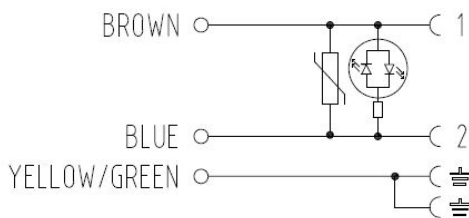

Technical Data

Connector Type	Form A EN175301-803
Cable Type	Single Ended
Connector A	-
Connector B	Female Angled
Contact Spacing	18 mm
Number of Poles	2 + 2PE
Earth Position	12 & 6
Jacket Type	PVC
Length	5 m
Body Material	Polypropylene
Contact Carrier	PA66
Circuit Type	Varistor + Bipolar Red LED
Gasket	NBR
Fixing Screw Size	M3x0.5 L28 mm
Fixing Screw Material	Fe/Zn
Rated Voltage	115 V
Rated Current	10A
Protection Class	IP67
Temperature Rating	-20 °C to +80 °C
Wire Gauge	3 x 18 AWG



In the USA: 1889 Maryland Ave., Niagara Falls, NY 14305
 In Canada: 3419 Mainway, Burlington, ON L7M 1A9
 Toll Free: 1-800-644-1756 • Fax: 888-283-2127
 service@htmsensors.com