

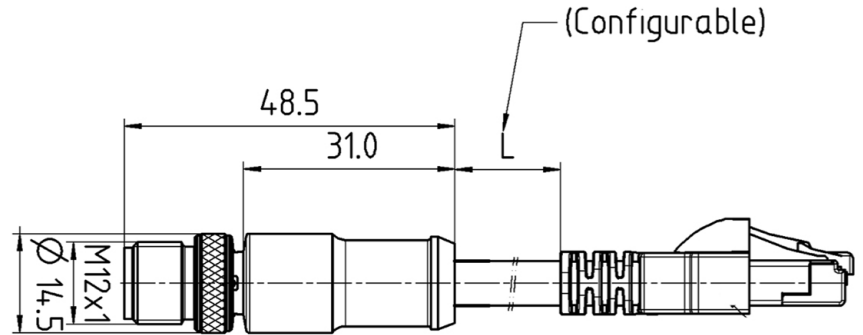

Note: The product images shown may change over time as products are updated.

Diagram



Part Number

DS-MS4TZ-T9725 + RJM45

Features

HTM Sensors stocks thousands of sensor cables for convenient same-day-shipping. Standard M8 and M12 cables have the best prices in the industry and are always available and in stock for customer requirements.

New advances in sensor cables allow for extended durability and longevity in the harshest environments.

Wiring

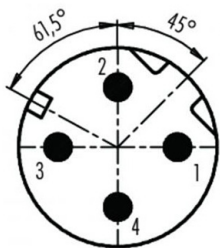

- 1 white/orange
- 2 white/green
- 3 orange
- 4 green

Technical Data

Connector Type	M12 D-Coded
Cable Type	Double Ended
Connector A	RJ45 Male Straight
Connector B	M12 Male Straight
Length	25 m
Locking System	Screw
Rated Current	4A
Rated Voltage	50 V
Wire Gauge	2x2x24AWG
Shielded	Yes to coupling nut
Contact Carrier	PUR
Molded Body	PUR
Contact Material	CuZn
Contact Plating	Au
Jacket Type	TPE
Coupling Nut	Zinc Die-cast Nickel-Plated
Protection Class	IP67
Temperature Range	-40 °C to +80 °C



In the USA: 1889 Maryland Ave., Niagara Falls, NY 14305
 In Canada: 3419 Mainway, Burlington, ON L7M 1A9
 Toll Free: 1-800-644-1756 • Fax: 888-283-2127
 service@htmsensors.com