



Architects

# Starting from the Bottom

Course Number: AIAPDH246  
3 LU|HSW

---

PO Box 449 Pewaukee, WI 53072 (888) 564-9098

[arch-support@edcet.com](mailto:arch-support@edcet.com)

## STARTING FROM THE BOTTOM Final Exam

1. A basic problem making it possible for mold to thrive is the unintentional creation of what is termed a \_\_\_\_\_.
  - a. Mold-friendly environment
  - b. Moisture sandwich
  - c. Meeting of requirements
  - d. Lack of competing organisms
  
2. Which of the following is often a source of incoming moisture?
  - a. Migration up from the earth
  - b. Water coming over the top of grade
  - c. Drainage off the structure
  - d. All of the above
  
3. Moisture content is the weight of the moisture contained in wood, compared to how much the wood weighs \_\_\_\_\_.
  - a. When it is dry
  - b. In average ambient temperatures
  - c. Just prior to harvesting
  - d. At the point of initial installation
  
4. Which of the following is not an external parameter affecting assembly performance?
  - a. Material substitutions
  - b. Design professional specifications
  - c. The climate in the project location
  - d. Evolving codes
  
5. Subfloor panels should be installed with their \_\_\_\_\_ perpendicular to the framing members.
  - a. Perimeter fasteners
  - b. Strong axis or long edge
  - c. Cross panel diaphragm
  - d. Short side or cross grain pattern
  
6. Table N1102.1.1 requires \_\_\_\_\_ floor insulation be used in climate zones 1-2.
  - a. R-13
  - b. Closed cell foam insulation
  - c. Loose fit batt
  - d. R-19

7. Different parts of Indiana are located in what two U.S. Climate zones?
- 5A, 6B
  - 6B, 4A
  - 5A, 7B
  - 5A, 4A
8. If the heating and cooling loads for the region are roughly balanced, some choose \_\_\_\_\_. .
- To use passive heating and cooling methods to save expense
  - To omit a vapor barrier from the assembly
  - To use only minimum mandated insulation levels
  - To forego installing any insulation at all
9. Water vapor's tendency to migrate from areas of higher temperature and higher relative humidity to areas of lower temperature and lower relative humidity is called \_\_\_\_\_ .
- Net zero displacement
  - Thermal displacement
  - Foreseeable moisture movement
  - Vapor drive
10. \_\_\_\_\_ is the atmospheric temperature below which water droplets begin to condense.
- Dew point
  - Point of saturation
  - 45 degrees, 75% humidity
  - 0 degrees Celsius
11. If a building must be built on a site with poor drainage, it is better to place it over \_\_\_\_\_ than over \_\_\_\_\_ .
- An open source of moving water, a lens aquifer
  - A basement, pressure treated pilings
  - An open crawl space, a wall-vented crawl space
  - 15 mil Visqueen, tar-impregnated felt
12. When installing a floating floor system directly over a slab, \_\_\_\_\_ should be maintained around the perimeter.
- A gap for expansion
  - A vapor barrier to resist moisture migrating up the drywall
  - Close proximity so trim can conceal poor workmanship
  - Enough space to insert a prybar if needed
13. If large amounts of water accumulate in crawl spaces or basements, this is usually expelled using \_\_\_\_\_ .
- A sump pump
  - Gravity flow
  - Perimeter drain tiles exiting to daylight
  - An internal gutter

14. When designing basements, the design goal is to make sure that water \_\_\_\_\_ .
- Does not make it inside at all
  - Has an easy path of escape
  - Can be captured and rechanneled for use as exterior irrigation
  - Can be used as grey water for interior non-potable use
15. \_\_\_\_\_ is not a term used to describe a barrier to the movement of moisture.
- Vapor barrier
  - Vapor dissipater
  - Vapor retarder
  - Vapor diffusion retarder
16. A Class \_\_\_\_\_ Water Vapor Retarder is rated between 1.0-10 perms.
- V
  - II
  - III
  - I
17. The easiest wooden floor framing system members through which to run piping and ductwork are \_\_\_\_\_ .
- Laminated joists
  - Wood joists of dimensional lumber
  - I-Joists
  - Floor trusses
18. When foam insulation is installed, \_\_\_\_\_ must also be sealed.
- Known sources of water
  - Fastener locations
  - Penetrations
  - Metal joist hangars
19. Which is not a basic type of mechanical fastener, used between subfloor panels and framing members?
- Smooth shank nails
  - Ring shank nails
  - Wood screws
  - Hangars
20. \_\_\_\_\_ is the industry standard for how to fasten subfloor panels to framing.
- Adhesives
  - Mechanical fasteners
  - Adhesives and mechanical fasteners
  - None of the above

21. The amount of force required to withdraw a fastener from a material is defined as \_\_\_\_\_ and directly corresponds to \_\_\_\_\_ .
- Withdrawal rating, fastener length
  - Fastener holding power, material density
  - Fastener grip, type and diameter
  - Ease of withdrawal, force used in application
22. Which of the following is not one of the primary means to avoid subfloors being installed with deflection?
- Hire only certified flooring installers
  - Use direct glue down hardwood flooring, to pull subfloor panels back up to level.
  - Use thicker hardwood flooring in greater lengths
  - Install blocking between joists or floor trusses at 24" O.C.
23. If moisture content is held below \_\_\_\_ %, this will substantially reduce mold growth in subflooring.
- 8
  - 22
  - 12
  - 18
24. The "X" used in plywood designations means \_\_\_\_\_ is part of its composition.
- Exterior grade glue
  - A face veneer of excellent quality
  - An internal veneer not suitable for surface appearance
  - Ten plies of very thin veneer
25. Integral spacers are used in high-performance subfloor panels to prevent workers onsite from \_\_\_\_\_ .
- Erasing suggested locations of fasteners
  - Installing panels so they don't act in cohesion
  - Hammering panels together to eliminate gaps
  - Stealing them for personal use

**STARTING FROM THE BOTTOM**  
**Copyright 2020, Paul F Spite**

**COURSE**

**STARTING POINTS**

**Introduction**

The problems illustrated below likely began long before a section of the floor collapsed or mold appeared. They may have begun when poor choices were made selecting materials for the foundation to floor assembly, in conjunction with the type of foundation chosen. As with many failures of flooring, the choices made resulting in proper or improper floor design begin at the bottom and work their way upward.



*Rotting Floor*



*Mold Heralding a Moisture Problem*

A poor time to discover problems with a floor system is once a building is completed. This is especially true when an issue manifests with an appearance of mold. Despite care taken in the selection of the assembled materials, this organism can sometimes appear on framing members and especially on the underside of subfloor materials. It doesn't take long before an appearance of mold is followed by compromised indoor air quality, endangering the health of occupants. Once mold growth has appeared on top the floor, repairs to remediate that problem will usually not end with surface treatment

A basic problem making it possible for mold to thrive is the unintentional creation of what is termed a "moisture sandwich." This occurs when water is allowed into the internal atmosphere of a foundation, crawl space or building assembly, but not permitted to escape in a timely fashion or at all. That trapped moisture creates a wet environment at the bottom surface of organic subfloor materials, making them ideal hosts for mold growth. Again, the solution to such flooring problems lies at the beginning of the design process.

Once the building is complete is a poor time to find that squeaking sounds are heard when walking. This occurs when something is moving in the floor system or building up internal stress. A release of that stress will result in popping sounds. Additional problems manifest when once-adhered flooring begins to delaminate. And being able to feel a floor system bouncing underfoot is always a bit disconcerting.

Knowing the solution to many such flooring problems begins with proper design and specification of flooring system components, we will examine those choices in their entirety in this course.

## **Designing in Entirety**

Creating a successful flooring assembly must include a proper design and specification of all system components. These are listed below, starting from the bottom up.

- The effort begins with an analysis of water movement on a site.
- Water movement on-site will help determine what type of foundation should be under and support the floor assembly. Site water characteristics, in conjunction with the foundation chosen, will play a large part in determining the extent and type of moisture present to plague floor systems from below.
- Incoming moisture, whether migrating up from the earth, coming over the top of grade, leaking in from drainage off the structure or landing as precipitation, will need to be controlled. If invading moisture cannot be prevented (and some will always be present) then barriers must be put in place to control its migration out, through or into the structure. This will involve vapor barriers and materials with different permeability in various locations. Equalization of, and movement of, moisture must be allowed to occur. If that does not happen, but moisture is continually entering space below the flooring, then water accumulation will occur and result in issues. That buildup happens as increasing amounts of moisture become trapped between impermeable layers, like vapor barriers.
- The choice of a framing system to support a floor and necessary building systems will determine whether excessive movement of the flooring system will occur, resulting in unintended gaps being created, ongoing damage and ongoing repairs.
- There are many available options for insulation systems in floors. These components, used to create a thermal (and sometimes moisture) separation between climates above and below the floor, are sometimes highly absorptive and will usually require special consideration.
- Successful performance of floor systems will also depend on materials chosen for the subfloor. It will become important whether the chosen subflooring allows movement of moisture in and out, and to what extent the material is permeable.
- Fasteners selected, especially those between framing members and subfloors, will factor into the long-term performance of flooring assemblies.
- Underlayment choices, if such materials are needed, will depend on installation requirements dictated by the finished flooring materials chosen, and by the manufacturers of that flooring.

- The permeability of the top surface, the finished flooring, will also be a factor in the long-term performance of a grade-to-finish floor assembly.

All these components hopefully work together to achieve the design intent: a firm surface that does not bounce underfoot, excessively deflect, harbor mold or rot or make noise during use. Understanding strengths and weaknesses of available choices requires a solid understanding of internal and external parameters affecting the long-term performance of each.

External parameters or environmental factors driving the transfer of moisture are largely outside of the influence of a designer. Internal factors are the results of our choices. We will examine those two categories momentarily.

### **Terminology and Concepts**

Defining a few basic terms and concepts will help shape an understanding of the discussion to follow.

Moisture migration: Water enters spaces below floors as groundwater from rain or as water vapor. It is as vapor that it moves upward into the conditioned space of the house, by way of diffusion or air leakage.

Water vapor migration by way of air leakage: Moving air carries water vapor with it, up through air leaks in the floor assembly. Controlling that movement requires effective air barriers and sealants.

Water vapor migration by way of vapor diffusion: Water vapor migrates through permeable building materials. Stopping that transfer requires the use of vapor retarders.

Vapor permeance: A measurement of how quickly water vapor diffuses through materials. The lower the “perm” rating, the less permeable or the more the material resists vapor diffusion.

Relative humidity (RH): A measurement of the amount of water vapor in the air, as compared to the maximum amount of moisture air can hold at that same temperature. Since warm air can hold more moisture than cold air, RH increases if the temperature drops while the moisture in it stays constant.

Dew point (DP): This is the temperature at which RH reaches 100% and water vapor condenses into liquid on surfaces.

Moisture content (MC): This is the weight of the moisture contained in wood, compared to how much the wood weighs when it is dry. MC is expressed as a percentage. The upper limit for MC is about 20%, after which decay can begin. MC varies with changes in RH, increasing as RH increases. It also varies somewhat with temperature. Additionally, wood expands and contracts as its MC changes.

## Review Questions:

1. The effort in creating a successful flooring assembly begins with \_\_\_\_\_ .
  - a. An analysis of water movement on-site
  - b. Recognizing the permeability of chosen subflooring panels
  - c. Installing two sump pumps, one as a backup system
  - d. The choice of a proper adhesive between floor and subfloor
2. Moving air carrying water vapor with it is termed as \_\_\_\_\_ .
  - a. Air infiltration leakage
  - b. Subservient air movement
  - c. Water vapor migration by way of air leakage
  - d. Initial absorption with delayed release

## EXTERIOR PARAMETERS AFFECTING PERFORMANCE

Despite a desire that it were not so, not everything that occurs on a project site is within the power of decision-makers responsible for the project outcome. Some of these uncontrollable variables can contribute to foundation to floor assembly failure. Below are a few examples.

### Wrong Place, Wrong Time (material substitutions)

Problems arise when workers on-site decide to substitute another material or product for those which have been specified in the design. Panel products used on one part of a job will most likely not be suitable to use everywhere on that job. If I-joists have been designated for a span and use, substituting wood joists of the same depth will not yield the same performance.

The use of incorrect materials is not that common, but it does occur. Construction administration and oversight must ensure that substitutions do not occur on-site without prior authorization.

### Unskilled Labor

“The best-laid plans of mice and men....”

The best-designed flooring system, using the best materials, will still fail if poorly or incorrectly placed, especially if components are installed with no regard for manufacturers’ instructions regarding the proper use of their products.

Common problems encountered with unskilled labor are:

- Improper storage of materials stockpiled on-site, to properly protect them from moisture exposure and absorption
- Improper protection from the elements after products are installed and before the building is enclosed



*Did We Have the Same Prints?*

- Material damage during handling and placement
- Failure to leave gaps between adjacent components, as recommended by manufacturers, to allow for expansion and contraction
- Improper spacing of fasteners or reducing the number of fasteners recommended or mandated
- Placing adhesive too far in advance and letting the adhesive dry too much before placing product on it
- Failure to protect placed material from damage in subsequent phases of construction

Improper installation can occur as simply as workers placing subflooring panels in the wrong orientation over framing members. Panels have a strong and weak axis and should be installed with the strong axis, or long edge, perpendicular to the framing members. Failing to do so can reduce the allowable loading on the subfloor by 75%.

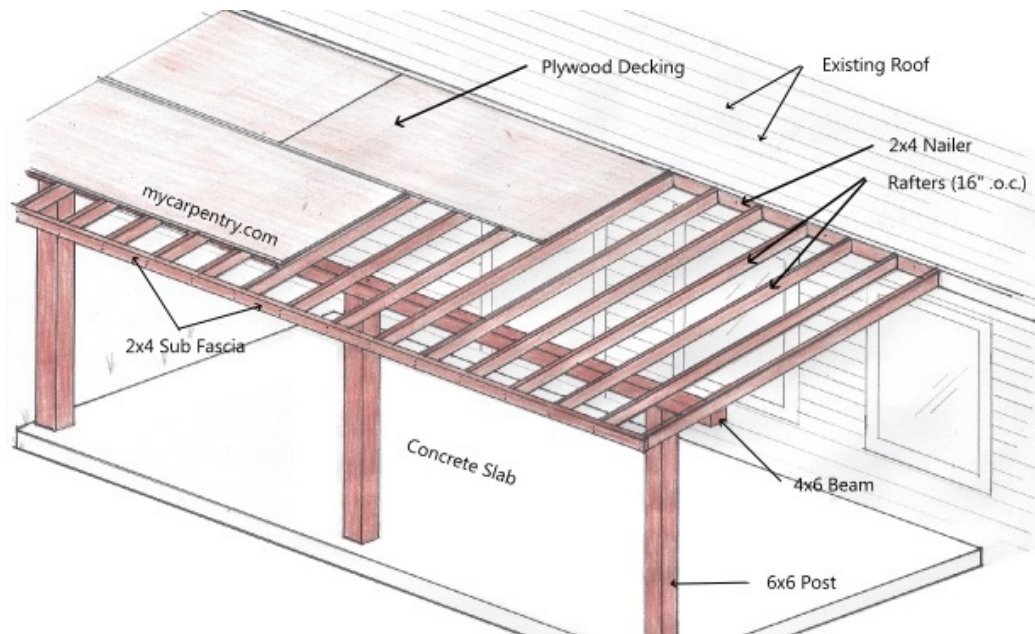

*Installing Panel with the Strong Axis*

In one personal example, floor trusses were designed and detailed with a built-in duct run manufactured within them. They stretched in a consistent span from one end of a small office structure to the other. The trusses were delivered early to a job site and the first third of them were set in place quickly, before I left. The supervisor also left to arrange delivery of framing lumber, and in the three hours he was gone, workers on-site placed the remaining floor trusses and screwed and glued down all subfloor panels. The only problem was that the central third of the floor trusses were set in place with the integral duct run on the other side of the central beam from the third of the trusses at either end. Given the glue used, that was a painful fix.

## Evolving Codes

Regardless of other choices to be made, codes and regulations must still be met to the letter, including those regarding the design of flooring systems. Changes in such codes will always impact and influence sub-flooring and flooring system design. Differences in those component requirements can arise with each iteration of code adopted. Such codes can include the recently-released IECC 2015, which has still not widely been adopted, the International Residential Code (IRC), air sealing codes, crawl space codes and requirements from ASHRAE.



*Codes and More Codes*

Some requirements of the IRC regarding floor systems bear mentioning.

- The use of vapor barriers is neither required nor prohibited in floors in climate zones 1, 2 or 3.
- The 2012 version does establish requirements for insulation and moisture control in crawl spaces.
- Definitions are given for vapor retarder class materials, along with their corresponding permeance.
- “Vapor permeable” is defined as materials achieving 5 perms or more.
- Section R316.5.4 establishes thermal/ignition barrier requirements for foam plastic insulation in crawl spaces.
- R408.1 sets out requirements for foundation vents and ground vapor retarder, for use in crawl spaces which are vented.
- Unvented crawl space requirements are found in section R408.3.
- Section R408.7 allows crawl spaces in flood hazard areas, if the finished grade of the crawl space is equal to or higher than the outside finished grade on at least one side. They must be able to drain by gravity. It also allows crawl spaces in these zones if their construction meets requirements of the FEMA Technical Bulletin TB-11.
- Table N1102.1.1 requires R-13 floor insulation be used in climate zones 1-2 and R-19 be used in zone 3.
- Table N1102.4.1.1 is where requirements can be found for floor insulation, air barrier and air sealing.
- N1102.2.7 reads, “Floor insulation shall be installed to maintain permanent contact with the underside of the subfloor decking.” A new exception allows an air space above the cavity insulation where insulation contacts the topside of sheathing or continuous insulation is installed on the bottom of floor framing, and where insulation at the rim joist meets the wood frame R-value requirements.

## Climate in Project Location

A general acknowledgment of the climate of a project is a good way to begin choosing components of a building. Materials should be chosen based on their ability to both function as intended and mitigate known risks like deflection or mold growth. As a curious side note, the more indigenous chosen building materials are to a region, the more local their raw material source, the more they tend to resist damage resulting from conditions in the local climate.

Dealing with incoming moisture begins with an analysis of the way groundwater moves across a site. The way in which precipitation will be directed off, down and away from the final structure must be anticipated and accommodated. Finally, the site must also be graded and landscaped to direct as much groundwater, precipitation and drainage away from the structure as possible. Preventing water from entering space below a building is far easier than dealing with it once it has arrived.

Vapor barriers in roof and wall systems should be on the interior side of the exterior insulation in cold climates (some define this as climates where 8,000 heating degree days or more are needed).

Vapor barriers in roof and wall systems should be on the exterior side of the exterior insulation in warm climates, where the greater demand is for cooling. A facade material impermeable to vapor is a good idea in these climates and can function as that barrier.

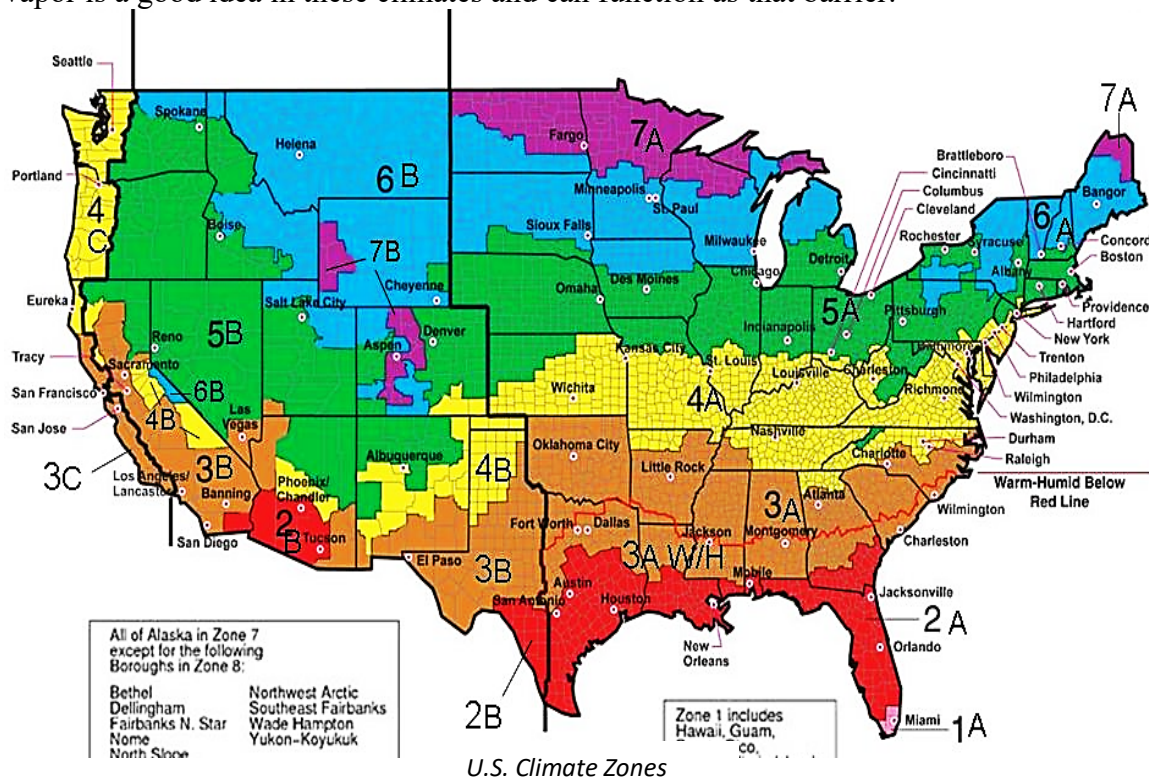

If the heating and cooling loads for the region are roughly balanced, some choose to omit a vapor barrier altogether from the assembly. They focus instead on paying more attention to balancing air pressure inside and out, as well as on controlling leakage and infiltration.

As a general rule, it's better not to have a vapor barrier than to install one in the wrong location. A good (bad) example of this would be vinyl wallcovering (impervious) installed on the inside of outside walls in warm climates.

Innovative materials, while new, exciting and seemingly cutting edge, also have no historical data regarding performance and compatibility with other materials. Be careful that a desired reputation for being in the forefront doesn't become replaced with a reputation for designing failing structures.

The possibility of water vapor condensing inside the cavity of a building assembly can be combated in multiple ways.

- Seal joints in the building assembly, or install air-resistant materials to prevent air from entering wall and roof system cavities. Seal around anything, like ducts, pipes or conduits, that penetrates these barriers.
- Install vapor barriers in appropriate climates, to inhibit the transfer of warm humid air.
- Protect building materials on-site from moisture prior to using them in the building. Try not to install, and subsequently encapsulate, wet materials.
- Reduce the number of open water sources in the building contributing to interior humidity loads.
- Set the HVAC system so it maintains indoor humidity between 30 and 50%, and internal air pressure to approximate exterior air pressure.

### **Air and Water Movement**

Without question, we will also have no influence over the laws of nature.

A basic understanding of air and moisture movement is beneficial to properly approach the design of floor systems. Flooring systems that absorb moisture can swell, rot or mold, creating problems for other components to which they are attached. This is especially true in hot, humid climates, even when systems and vented or open crawl spaces are built in accordance with building codes.

Water vapor migrates from areas of higher temperature and higher relative humidity to areas of lower temperature and lower relative humidity. This natural mechanism is called "vapor drive." In a humid climate, when an A/C is operating, vapor tends to drive up from a hot damp crawl space, into the relatively cool and dry climate of the inside space, by permeating through the floor assembly. If impermeable floor coverings trap moisture in the wood subfloor, that can lead to condensation and high wood moisture content.

The rate at which moisture accumulates varies by season, indoor temperature, types of floor insulation, floor covering and the type of crawl space involved. Ideally, insulation systems and floor coverings will control moisture migration from vented and open crawl spaces, but allow floors to dry, should they become wet.

Regardless of how well we plan, the following truths about moisture migration will always need to be taken into account.

- Wood has a strong affinity for water vapor. In a relative humidity of 50% at room temperature, wood holds about 10% of its dry weight as absorbed moisture. This percentage commonly is called moisture content. In 80% relative humidity, wood moisture content averages about 16%.
- A traditional approach to protecting wood products from rot or decay is keeping moisture content below 20%. However, mold growth can occur on wood at levels above 15-18%, and corrosion of metal fasteners can occur when moisture content exceeds 18-20%. A better goal might be keeping moisture to less than 15% MC.
- When moisture content increases, wood expands. When wood dries, it shrinks. With ongoing variance between expansion to contraction, damage will occur depending on how much moisture content fluctuates and how sensitive construction or wood products are to such changes.
- Most air contains some measurable percentage of humidity. Laws of thermodynamics causing hotter air to rise and cooler air to settle mean that air being displaced in either direction can carry moisture from one location to another.
- Hydrostatic pressure will cause vapor to migrate from areas of higher moisture concentration to areas of lower moisture concentration and from areas of high pressure to areas of lower pressure. This vapor drive will occur even when moisture must make its way through seemingly solid building materials to relocate. For our purposes, several factors determining the speed at which moisture so travels are a difference in pressure from one side to another, difference in temperature, difference in moisture concentration from one side to another and permeability of the barriers in place that impede the progress of moisture.
- There will almost always be a difference in temperature and humidity between exterior and interior environments. These two will also always be striving to reach a point of equilibrium, hence the movement of vapor. The difference will also tend to result in materials that are cooler on one side than the other, creating surfaces on which air-borne moisture on the warmer side can condense.
- Dew point is the atmospheric temperature below which water droplets begin to condense and dew forms as droplets on surfaces. It is hard to define precisely where a dew point will be, since it also varies according to the air pressure, temperature and humidity present.
- Vapor can also wick upward through porous materials in what is described as capillary action. This movement results in changes in indoor air quality and even in the structural capacity of materials being invaded.



*Thirsty Wood*

- Vapor barriers have specifically been created to slow or stop the transfer of such migrating moisture. Some materials created for other uses will also naturally perform as vapor barriers to some degree.
- Controlling this vapor drive is important, because moisture trapped or contained in materials will have decidedly adverse effects on it. If other growth criteria are present and levels of moisture reach and remain above 15 to 18%, mold growth can occur and organisms causing decay can thrive. When moisture levels reach above 18 to 20%, fasteners can corrode. Absorption of moisture can result in fibers in wood swelling, causing buckling, a loss of strength and a loss of capability to grip fasteners. These will be explored in more depth later.
- If a tented tarp system is used to protect stored panels from the elements, make sure to provide airflow between the tarp and wood subflooring. This will prevent trapping water between the tarp and the wood surface, which may lead to mold and mildew.
- If materials are expected to be exposed to moisture, there must also be a way for them to dry afterwards. It is when drying cannot occur that degradation of materials occurs. When panels are exposed, standing water must be removed as soon as possible. Drying can be done with electric heaters or already installed HVAC systems. Ice and snow can safely be removed with dark, coarse sand or with non-sodium-based materials.

### Review Questions:

3. Improper storage of materials stockpiled on-site fails to properly protect them from \_\_\_\_ .
  - a. After-hours theft
  - b. Moisture exposure and absorption
  - c. Damage from insect infestation
  - d. Improper installation due to warping
4. The use of vapor barriers is \_\_\_\_\_ by the IRC, in floors in climate zones 1, 2 or 3.
  - a. Encouraged, but not required
  - b. Neither required nor prohibited
  - c. Deemed an unnecessary expense
  - d. Enough reason to red tag construction
5. \_\_\_\_\_ is where requirements can be found for floor insulation, air barrier and air sealing.
  - a. Climate zone maps
  - b. ASHRAE climate indicators
  - c. Occupancy classification tables
  - d. Table N1102.4.1.1
6. Reducing what in a building will help to lower interior humidity loads?
  - a. Open water sources
  - b. The number of single user toilets
  - c. Landscaping sprinklers next to structures
  - d. Solar heat gain contributing to evaporation

7. To combat the possibility of water vapor condensing inside the cavity of a building assembly, HVAC systems can be set to maintain indoor humidity \_\_\_\_\_ .
  - a. Between 30-50%
  - b. Between 0-5%
  - c. At the same level as that outside
  - d. At a dew point higher than 64 degrees
8. To protect wood products from rot or decay, keep moisture content below \_\_\_\_\_ .
  - a. 42.5%
  - b. 20%
  - c. Obvious saturation levels
  - d. 11%

## INTERIOR PARAMETERS AFFECTING PERFORMANCE – OUR CHOICES

The internal parameters that affect what we have designed can be simply described as our choices. It is beneficial to look at decisions made at each step of the design of flooring systems. This includes examining specific concerns inherent in the use of each specified component in the chosen floor assemblies, because each material or method chosen can and will affect the performance of the floor once construction has been completed. Those choices will literally begin at the bottom and work their way upwards.

### Managing Incoming Moisture

A properly-graded building site will direct ground water away from a structure and will obviously play a large part in how much water accumulates in the soil beneath that building. Allowing water to accumulate, especially in wall-vented crawl spaces, will create a source of rising humidity to trouble the floor system above. One way to prevent moisture in the earth from rising is to cover soil with a vapor barrier like polyethylene, at least 6 mil thick. This has proven over time to be very effective, assuming of course that water entering the soil below cannot wind up on top of that vapor barrier.



*Redirecting Groundwater*

Humidity levels in open crawl spaces tend to equalize with humidity levels out in the open air. This means that evaporation from soil below the structure is quickly diluted or relocated by the fresh air coming in from outside. So if a building must be built on a site with poor grading and/or drainage, it is safer to place it over an open crawl space than over than a wall-vented crawl space.

As noted earlier, vapor tends to migrate from areas with higher temperatures to areas of lower temperatures, and from areas of higher concentration to areas of lower concentration. So in practical terms, when a building is air-conditioned in a hot, humid climate, vapor will migrate through the building envelope, moving from outside inward, seeking the cooler atmosphere with less concentration of vapor. This movement is defined as an inward vapor drive.

This movement of moisture also means that, if possible, water will be driven upward from the crawl space and into or through the subfloor. Water so absorbed will still be trying to move toward, and therefore dry toward, the inside. But if the components are getting wet faster than they are drying, water will accumulate in the subfloor. If those panels stay wet for too long, mold or rot can take hold.

To prevent upward moisture migration, insulation should provide resistance to that vapor drive. If the insulation does not prevent it, an adequate vapor barrier should be put in place.

### **Foundation Considerations**

As the next step moving upward, the foundation system supporting the floor must be chosen or at least acknowledged. If a slab is utilized, then the method of installing the floor above must be chosen. If a crawl space will be used, will it be open, vented or enclosed, and given the climate and site, how will foundation choice affect the migration of moisture upward into the floor? If a basement is used, will a drain tile and / or a sump pump be installed and how will moisture infiltration be handled?

Success in these choices will determine whether proper support will be in place for the floor framing. As the first major barrier to water, the chosen foundation will also affect the extent and type of moisture that enters below, to create some moisture-related issues plaguing floor systems. Proper foundation design includes not only structural considerations, but also proper design of venting, insulation and vapor control components.

Let's look further at our choices in foundations.

### **Placement on Slabs**

Finished flooring is often placed directly over concrete slabs, especially in basements and in high-rise construction. Before any additional method of attachment is used, slabs should be covered with a minimum 6 mil of polyethylene sheeting, spot-glued to the slab with an adhesive that bonds to concrete and plastic. That vapor barrier should be lapped a minimum 4" at the joints, glued at joints to ensure an adequate moisture seal and extended up side walls a few inches. Then the excess amounts should be trimmed after the subfloor is installed. Afterward, subflooring can be attached using direct attachment, sleeper systems or a floating floor system.



*Direct Attachment*



*Floating Floor*

When directly attaching subfloor panels to slabs, a ¼” gap should be maintained around the perimeter for expansion. Panels can be fastened down with masonry nails, concrete fasteners or powder-actuated fasteners. Manufacturer’s directions should be followed for instructions on the fastening schedule. Spacing between subflooring panels should still be maintained for expansion.

A floating floor system consists of a first layer of subflooring laid over the vapor barrier, followed by a second layer of subfloor with a reversed orientation. These layers are topped by a felt to separate the subfloor from the finished floor. Dimensional stability of the subfloor panels is critical to the success of this system, as is a high resistance to moisture to minimize potential panel swelling. Especially in high-rise construction, this floating system, not having a subfloor mechanically attached to the concrete below, helps prevent sound transfer between units. That lack of attachment also means that later, floors will be easy to remove and renovate if needed. The lack of fastener penetrations also helps preserve the structural integrity of the slab below.

### Placement over Crawl Spaces

It is not always possible to direct all groundwater away from a building. Thus, some building codes dictate that raised floor foundations, especially in areas prone to flooding, allow water to move through and out of the space below the building.

Even in these site conditions, for better control of the internal environment, closed crawl spaces are sometimes considered. Breakaway panels

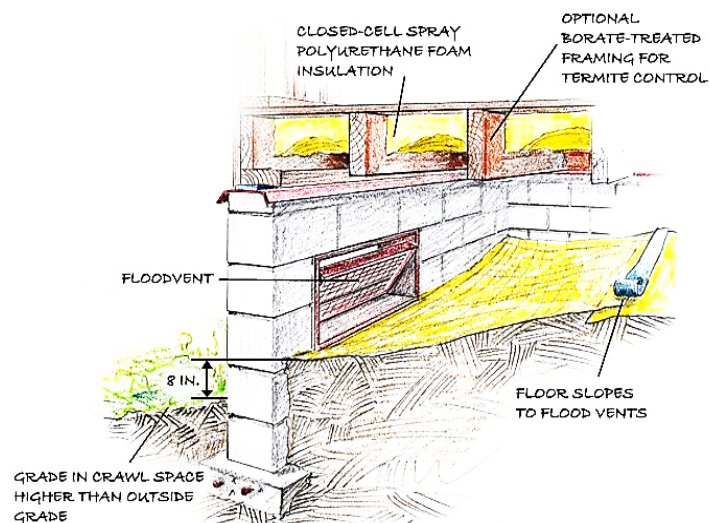

*Floodproofing a Crawl Space*

or vents can be used in closed crawl spaces. These normally stay closed, but will open when subjected to the pressure of floodwaters.

However, the jury is still out as to whether these outlet mechanisms seal tightly enough in their normal position to actually create an airtight crawl space. And after such panels open and allow floodwater inside, the perimeter walls can prevent that same water from properly draining back out or drying out. This fosters the growth of mold and rot. Because of such issues, closed crawl spaces are not usually recommended in areas that flood.

For the purpose of discussing moisture management, crawl spaces can be classified into three primary types or options.

- Open individual piers of wood, concrete or masonry, are used to support beams, rim joists and floor joists. A system defined as an open crawl space uses these and may have one continuous wall on the high side of the grade from which ground water might be expected to enter. This high side wall should deflect a significant portion of water seeking entry. The other sides are normally left unenclosed. That way, any water that does enter below the structure can drain easily and naturally.



*Open Crawl Space*

- A second type of crawl space uses continuous perimeter walls, usually of masonry, with vents installed to the outside. This type of crawl space is called a wall-vented crawl space. If water gets inside, open vents allow some hot, humid air to work its way out. Then circulating air helps evaporate moisture that remains and lets the crawl space dry over time. This system is intended to control humidity levels below the structure. Drains are put in place to collect and expel water. Additionally, pumps are placed in sump pits to expel large amounts of water that have made their way inside.

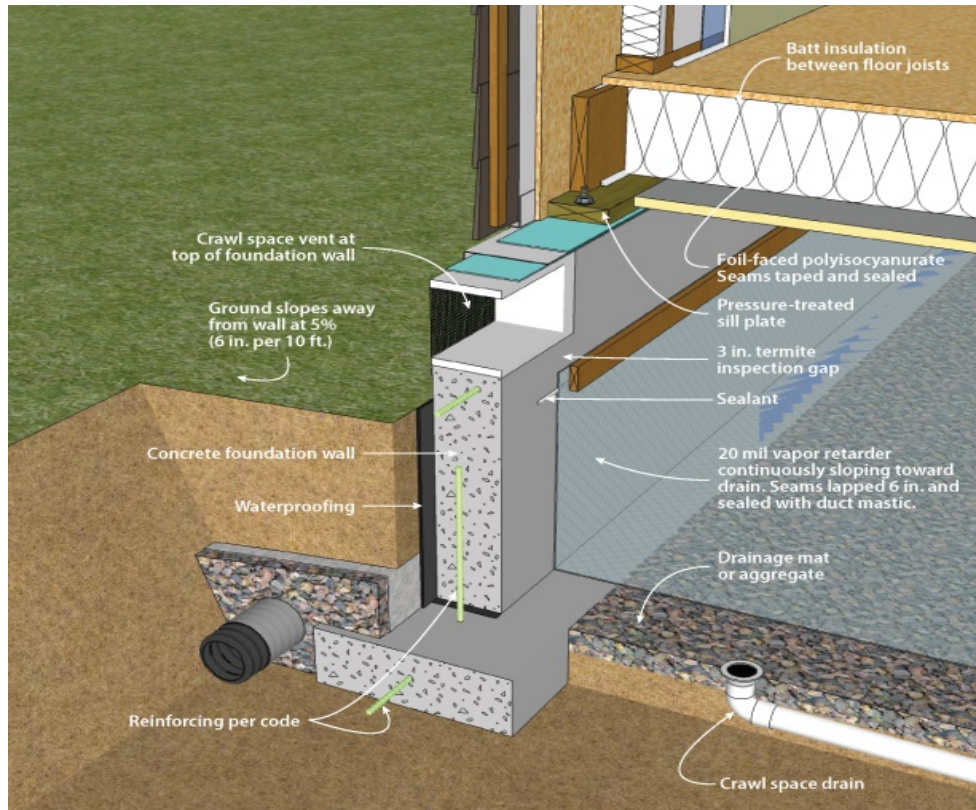

*Vented Crawl Space Construction*

- Crawl spaces that have continuous perimeter walls and do not contain vents are defined as closed crawl spaces. This complete, airtight enclosure effectively makes a crawl space part of the interior environment. Generally, the walls and the floor are completely encapsulated in sealed vapor barriers. Insulation can be installed on perimeter walls or below the floor. Then conditioned air is often supplied to the crawl space. Crawl space humidity is controlled by a dehumidifier, exhaust vents or simply with the HVAC system. While this is beneficial to the climate and energy use of the spaces above the floor, it also offers almost no way for any water that does enter, to escape. For this reason, closed crawl spaces are not recommended in areas prone to flooding.



*Unvented Closed Crawl Space*

## Placement over Basements

When a building is being placed on a basement, the design goal is that water does not make its way inside at all. Exterior waterproofing on the basement walls is typically combined with a perimeter drain tile to capture any water that does come down the waterproofed walls and carry it away before it can seep inside. But just in case exterior defense systems are overwhelmed or fail, many basements also include an installed sump pump, to capture and carry away any leakage before that moisture can begin migrating upwards toward the floor assembly.

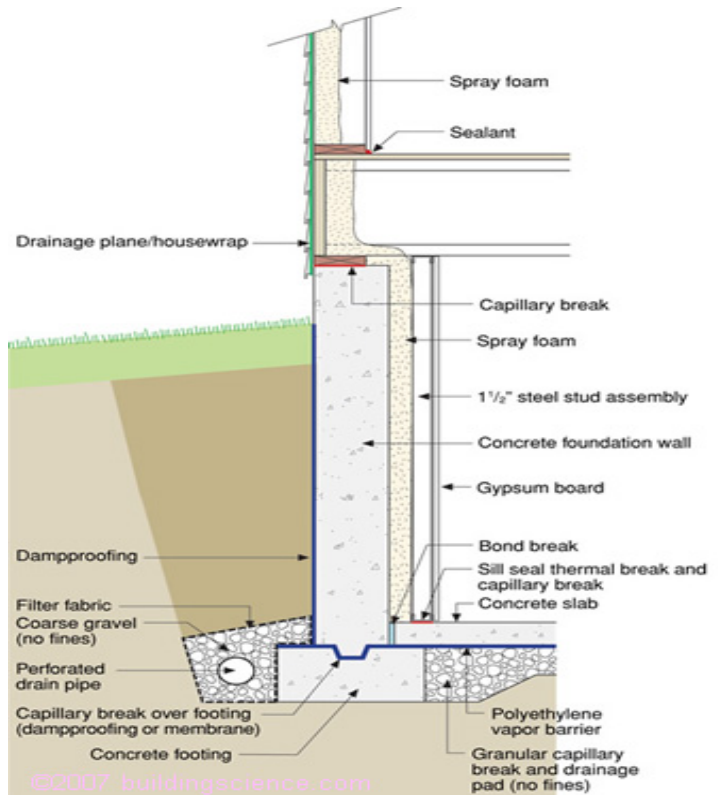

*Consider Waterproofing in the Design Phase*

The next decision made, when moving upward from the bottom, involves where, when and of what material a vapor barrier should consist, if any.

A vapor retarder of some sort is normally placed between a floor assembly and sources of moisture below.

The lowest vapor barrier is sometimes placed below a basement or crawl space slab, or over the earth in a crawl space. Vapor barriers used in these locations are difficult to properly seal or to keep sealed over time. If they separate, moisture can be expected to eventually migrate upwards through a concrete slab or through earth and / or gravel in the bottom of a crawl space.

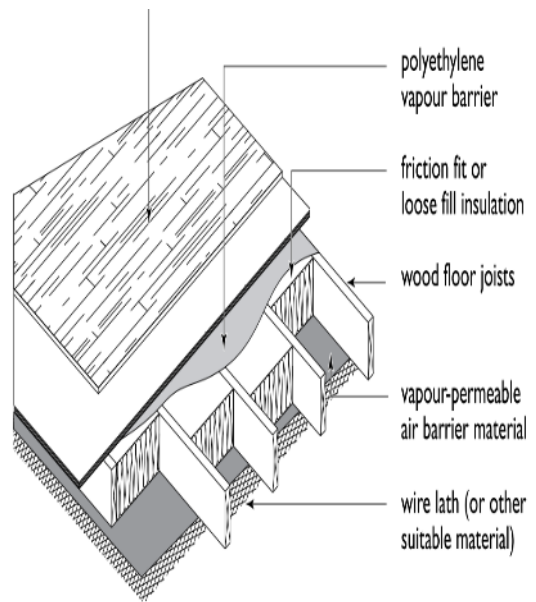

*Vapor Barrier Placement*

## Vapor Retarders

Many materials are used in part or in whole to hinder or stop the movement of moisture. Vapor retarders like Visqueen or other plastics, impervious backing on insulation or additional impervious sheathings are often placed between basements or crawl spaces and the flooring assembly above. These layers are added to slow or eliminate moisture migration from below,

keeping it from making it up into the higher materials of a flooring system. These vapor barriers are intended to form a continuous layer, but some joints are difficult to completely seal and keep sealed over time. When sealed joints in vapor retarders fail, moisture migration **increases**.

Vapor barriers can also be referred to as vapor diffusion retarders. Some interfere with the vapor drive inside an assembly. As mentioned earlier, these should be installed on the side of the cavity consistently exposed to the highest vapor pressure. In very hot or very cold climates, that distinction is easily made. In more temperate climates, a choice of placement becomes more difficult.

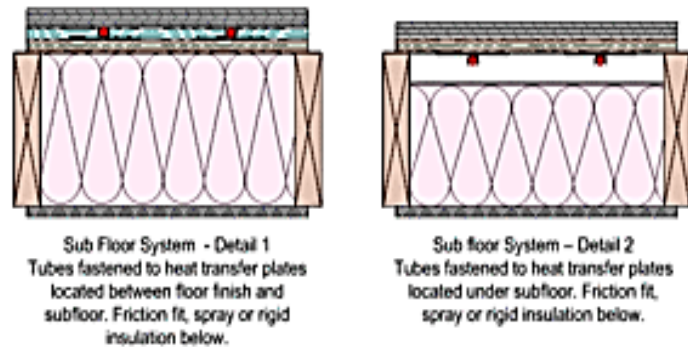

In any event, care must be taken that only one vapor barrier, or material that can act as one, be placed in an assembly. Otherwise, moisture may become trapped between the multiple barriers. Plastic sheeting, Kraft paper, foam plastic sheeting / insulation, solid vinyl wall covering and asphalt-impregnated building paper are all building materials known for their use as vapor barriers. Not as well-known are unfaced insulation, building paper without asphalt compounds, plywood sheathing and building wraps like Tyvek. All these materials retard vapor flow to some degree.

Vapor barriers must be correctly installed in order to be effective. Insulation in cavities should fill all the voids before installing any vapor barrier. The vapor diffusion retarder must then be properly sealed at seams, per its manufacturer's recommendations. Care must be taken to also properly seal at openings. When fastening them in place, barriers should be secured with no fasteners allowed to tear through the barrier itself, leaving holes through which moisture can migrate. That is much easier to say than accomplish.

### Water Vapor Retarder Classifications

- Class I: 0.1 perm or less – described as Vapor Impermeable – i.e. Sheet polyethylene, 6 mil (0.06 perms)
- Class II:  $0.1 < \text{perm} \leq 1.0$  perm – described as Vapor Semi-impermeable – i.e. Kraft-faced fiberglass insulation (0.3 perms)
- Class III:  $1.0 < \text{perm} \leq 10$  perm – described as Vapor Semi-permeable – i.e. OSB (1-2 perms); Grade D building paper (5 perms)
- Greater than 10 perms – described as Vapor Permeable – i.e. Fiberglass insulation (unfaced)

### Tips for Using Water Vapor Retarders

Used correctly, vapor retarders prevent diffusion of water vapor up into assemblies. Used incorrectly, they can trap water and prevent wet materials from drying out. The following rules-of-thumb are generally true and may help prevent costly mistakes.

- If put in place beneath framing, vapor barriers should be placed on the outside of floor insulation, facing the crawl space.
- Care should be taken to ensure that two materials acting as vapor retarders do not wind up on opposite sides of assemblies and trap moisture inside the assembly.
- Ideally, floor coverings should be chosen that allow upward drying to occur. Otherwise, if another vapor barrier is already in place further down, impervious flooring may create a second vapor barrier.
- In hot-humid climates, during the cooling season:
  - The moisture content of a subfloor above a crawl space can be lowered by setting air conditioning at a higher temperature, by installing flooring that is more permeable or installing insulation below flooring that is more impermeable.
  - Since air temperature and DP differ only slightly from the outdoors in an open crawl space, a vapor retarder on the ground has no measurable effect on moisture content in a wood subfloor, above an open crawl space.
  - Air and surface temperatures in a vented crawl space can be much cooler than outdoors and indoors, even when the dew point is still about the same. This can result in a higher relative humidity, more condensation and increased moisture content in the wood, as compared to what occurs using an open crawl space.
  - In an unvented crawl space, relative humidity can be controlled, preventing moisture from accumulating in the wood components.

A higher vapor barrier is created in two ways. One is when moisture cannot penetrate upward through impervious subflooring, effectively making that component a vapor barrier. The second is when flooring choices are made and installed, like sheet vinyl or luxury vinyl tile, that also happen to be relatively impervious.

Unless other measures are introduced to control any created moisture sandwich between an upper and lower vapor barrier, humid air will reside therein and foster organic growth. Ventilation and exhaust systems can be introduced to move moisture-laden air back outside a crawl space and encourage drying of the assembly. HVAC systems can also dry the air, if enclosed space below the floor is included in areas being tempered by the system.

### Review Questions:

9. Which of the following is not an interior parameter affecting floor assembly performance?
  - a. Foundation considerations
  - b. Moisture and vapor control measures
  - c. A back-up floor framing system
  - d. Grading of the building site
10. In areas prone to flooding, raised floor foundations should \_\_\_\_\_ the space below the building.

- a. Be set up to preheat air entering
  - b. Float above a seal sealer on top of the foundations of
  - c. Allow water to move through and out of
  - d. Require the use of impervious materials in all
11. Which of the following is not one of the three primary types of crawl spaces?
- a. Open crawl space
  - b. Wall-vented crawl space
  - c. Closed crawl space
  - d. Pier and pad crawl space
12. Which of the following is not recommended for use in areas prone to flooding?
- a. Open crawl space
  - b. Wall-vented crawl space
  - c. Closed crawl space
  - d. Pier and pad crawl space
13. The lowest vapor barrier is sometimes placed \_\_\_\_\_ .
- a. Below a basement or crawl space slab
  - b. Over the earth in a crawl space
  - c. Both of the above
  - d. Neither of the above
14. One way a higher vapor barrier is created is when \_\_\_\_\_ .
- a. Adhesive is used on all subfloor and framing surfaces to adhere insulation
  - b. Moisture cannot penetrate upward through impervious subflooring
  - c. Exhaust fans evacuate humid air before it can rise to the level of the framing
  - d. It is installed, despite specifications to the contrary

## **Framing System Choices**

Moving even further upward, we encounter the framing members used to hold up floor assemblies. Choices made here will not only determine how the assembly handles moisture content, but also how it resists movement, degradation, longevity of flooring and so on.

The members needed for floor framing are chosen based on multiple criteria. These include spans to be bridged, products readily available for the job, species of which the members will be manufactured, the use of natural versus engineered products and how much deflection can be tolerated before subflooring and finished flooring performance will be compromised.

Design issues for individual framing members include materials used, profiles and types, size and spans of the framing supporting the subfloor. If framing can move, bounce or rotate beyond allowable limits, the subflooring and flooring above it will not remain in place for long.

The amount of water or vapor allowed to come into and remain in contact with framing members will also affect their performance. This will vary based on the season in which construction occurs, the speed in which it does so, and the amount of protection put in place on the job site to protect floor framing components against precipitation.

### Sizing Framing Members

- When floors are supported by a concrete slab on grade, there are still design issues that can affect flooring performance, but span of framing members is not a usual concern.
- When sizing members, deflection criteria (how much bending can be expected to occur under predetermined amounts of dead and live loads, by members of a predetermined wood species, placed at a predetermined spacing over a predetermined unsupported span) is typically a primary criteria. Any bending movement will be what the occupant feels when walking on the floor system. The maximum amount of bending considered permissible is usually set by building codes. The expected amount of bending, for all those predetermined criteria, has already been determined by past testing. It is published in table form by most wood framing suppliers or trade associations of the same.
- Problems encountered in properly sizing wood framing members have to do with dimensional stability and how many natural defects are contained in them. The longer a specified wood framing member, the more difficult it will be to find and use members that are straight, neither cupped nor warped, not twisted and free of structural defects such as knots.
- Since the performance of natural wood framing members also depends upon their dimensions, and those dimensions can vary with changes in the moisture content trapped in wood fibers, so will the load bearing capacity of framing components vary as a building dries during occupancy.

### Limitations of Dimensional Wood Framing

- Each separate piece of lumber framing can differ in size, moisture content, structural flaws, load bearing capacity, species, etc. This can obviously make planning and engineering difficult. It pretty much forces sizing of individual members to be based on worst possible scenarios.
- Natural defects in wood, like knots and splits, compromise performance of individual members.
- Untreated lumber can expand and contract in the framing stage as members are subjected to moisture on-site and drying after the space becomes conditioned.
- The higher the vertical profile of a wood joist, the more likely it is to find cupping in the member, making tight installation of fasteners and flooring difficult.
- When using metal joist hangers to support joists or trusses from beams, it is important to specify the correct hanger for the job. Fasteners adhering the hanger to the joist and the hanger to the beam must be used in each provided hole. Eliminating mandated fasteners will allow unintended rotation of the floor framing member and result in squeaks and loosening of fasteners that were installed.
- If fasteners are missed or installed at improper spacings, the strength of the whole assembly is compromised.



*Floor Joist Framing*

- Combining glue with fasteners to adhere a subfloor to a framing system results in much better structural performance of both of these parts of a flooring assembly. It also greatly reduces movement between them, a main source of floor squeaks.

Such difficulties with natural products necessitated the invention of engineered wood framing systems, like floor trusses and I-joists. Engineered products can span significantly longer distances in a stiffer configuration than their natural counterparts of the same size. Again, performance of these members is determined by manufacturers of these components, based on testing under loading.

MEP trades come onto a job site well after the framing of floor systems has been completed. If a ceiling will be adhered to the bottom, or near the bottom, of the floor framing, it is not unusual for workers in these trades to cut holes through joists to install components of their work. As can be imagined, natural wood joists are dangerously weakened as a result. I-joists generally have specified areas designed into them where holes can safely be created for running systems, based on the manufacturer's recommendations.

Pre-engineered floor trusses have plenty of space designed into them, through their webs. Piping can pretty much be run anywhere it is needed, without weakening anything. Duct runs of specific sizes can be designed into floor trusses as well.



*I-Joist Framing*



*Floor Truss Framing*

### **Climate Separation via Insulation**

Our next set of choices involves more of a lateral than a vertical move. Once framing is in place, it is available to support insulation, should between or below the framing be a desired location. Installed insulation will play a large part in preventing condensation from forming on the warm side of a floor assembly, particularly on or just below the surface of the finished floor.

### Insulation Types

The 2015 IECC Code prescribes a minimum R-value for floor insulation to be R-19 in climate zone 4 and R-30 in climate zones 5 and 6.

How fast floors, walls or ceilings will be able to dry after becoming wet will be affected by thermal insulation. The purpose of insulation is to slow the transfer of heat, to keep heat inside during the winter and heat outside in the summer. But besides impeding the flow of energy, insulation can also impede the transfer of moisture. Its success in doing so varies widely, based on the composition and thickness of different insulation choices. Insulation's limitation on heat flow will cause certain parts of the floor assembly to be warmer or colder than their surroundings. That will matter, since wood dries when it is warmer than its surroundings, but attracts moisture from the air when it is cooler than what surrounds it.

Some insulation types used in crawl spaces may need to also be protected from fire. Spray foam or rigid foam must be fire retardant or covered with a thermal barrier like  $\frac{3}{8}$ " gypsum or  $\frac{1}{4}$ " plywood. An ignition barrier, like a foil-faced product or approved spray applied coating, can also be used. Because of their paper surfaces, some Kraft-faced products may also need a thermal or ignition barrier.

Insulation is usually added to a floor framing system to separate a climate-controlled space above from one below that is not. That insulation can be problematic, since in many forms, it can also accept and hold moisture that migrates past vapor barriers below it. There are multiple insulation choices currently in use between crawl spaces and basements, and the floors above them. A few are described below.

- A 2"-thick, rigid, foil-faced polyisocyanurate foam insulation is installed below the floor joists. All seams are sealed with foil tape, penetrations are sealed with spray foam and rim joist areas are insulated with spray foam. This material inherently resists moisture.
- A 2" average thickness of approximately 2 pounds per cubic foot of closed cell sprayed polyurethane foam is applied just below the subfloor. While this product is moisture-resistant, framing members are left unprotected to absorb vapor.
- A 2.6" average thickness of medium-density (1 pound per cubic foot) open cell sprayed polyurethane foam is applied just below the subfloor. While this product is moisture-resistant, framing members are left unprotected to absorb vapor.
- A 3.4" average thickness of low-density (0.5 pounds per cubic foot) open cell sprayed polyurethane foam is applied just below the subfloor. While this product is moisture-resistant, framing members are left unprotected to absorb vapor. Sometimes, one coat of a spray-applied vapor retardant paint coating is also applied. This will protect the joists as well.
- 6.25", Kraft-faced fiberglass batts are installed between floor joists with the impervious Kraft barrier facing up against the subfloor, supported by metal rods. Moisture will migrate up into the insulation.

### Recommendations for Combining Insulation and Floor Covering Types

To ensure that impervious insulation systems are not topped by impervious flooring materials, inadvertently creating a moisture sandwich, recommendations have been provided for which insulation choices work best with which flooring choices. These precede updated R-value requirements, but are still good recommendations.

- Un-faced fiberglass batt, 3.5" (R-13) - Permeable (34 perms) - Recommended for only permeable floor coverings; discretion is advised for semi-permeable coverings
- Open cell (polyurethane) spray foam, 3.5" (R-13) - Permeable (25 perms) - Recommended for only permeable floor coverings; discretion is advised for semi-permeable coverings
- Expanded polystyrene (EPS) rigid foam, 1" (R-4) - Semi-permeable (2.0-3.8 perms) - Recommended for permeable and semi-permeable coverings; discretion is advised for semi-impermeable coverings
- Closed cell (polyurethane) spray foam, 1" (R-6) + fiberglass batt - Semi-permeable at (1.6-2.0 perms) - Recommended for permeable and semi-permeable coverings; discretion is advised for semi-impermeable coverings
- Kraft-faced fiberglass batt (sealed seams) - Semi-impermeable (0.3 perms) - Recommended for permeable and semi-permeable coverings; discretion is advised for semi-impermeable coverings
- Extruded polystyrene (XPS) rigid foam, 1" (R-5) + fiberglass batt - Semi-impermeable (0.8 perms) - Recommended for permeable, semi-permeable coverings and semi-impermeable coverings; discretion is advised for impermeable coverings
- Closed cell (polyurethane) spray foam, 2.5" (R-15) - Semi-impermeable (0.8-1.0 perms) - Recommended for permeable, semi-permeable coverings and semi-impermeable coverings; discretion is advised for impermeable coverings
- Foil-faced (non-perforated) fiberglass batt (sealed seams) - Impermeable (0.05 perms) - Recommended for permeable, semi-permeable coverings and semi-impermeable coverings; discretion is advised for impermeable coverings
- Polypropylene-faced (non-perforated) XPS, any thickness - Impermeable (<0.1 perms) - Recommended for permeable, semi-permeable coverings and semi-impermeable coverings; discretion is advised for impermeable coverings
- Foil-faced polyisocyanurate rigid foam (R-5.7/in), any thickness - Impermeable (0.06 perms) - Recommended for permeable, semi-permeable coverings and semi-impermeable coverings; discretion is advised for impermeable coverings



*Choices in Insulation*

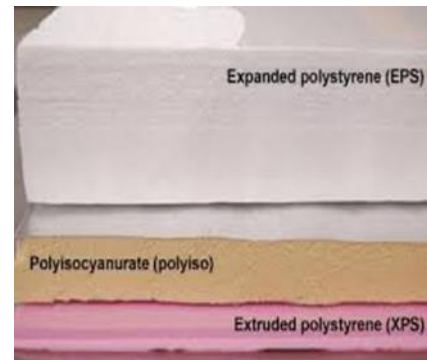

*Choices in Insulation*

### Review Questions:

15. Which of the following is not among the criteria used to choose floor framing members?
  - a. How much deflection can be tolerated

- b. Available credit lines at local suppliers
  - c. Spans to be bridged
  - d. Products readily available
16. Variations in natural lumber framing members pretty much forces sizing of individual members to be based on \_\_\_\_\_ .
- a. Worst possible scenarios
  - b. Largest available sizes
  - c. Cross sectional area, rather than height
  - d. The number of visible flaws
17. The 2015 IECC Code prescribes a minimum \_\_\_\_\_ R-value for floor insulation in climate zones 5 and 6.
- a. R-13
  - b. R-19, but it must be closed cell
  - c. R-19
  - d. R-30
18. Closed cell sprayed polyurethane foam, applied just below the subfloor, is moisture-resistant, but still \_\_\_\_\_ .
- a. Leaves framing members unprotected to absorb vapor
  - b. Can curl away from surface edges over time
  - c. Needs inspected afterward to ensure no gaps were created
  - d. Needs holes drilled through it to permit free moisture migration

## **Fastener Selection**

Moving upward again, between framing members and the subflooring will be the fasteners that tie these two components together. These take two basic forms.

### Adhesives

Adhesives are used to create a continuous bond between subflooring and framing. When properly applied, adhesives eliminate any movement between framing and subfloors. There are different types of adhesives available.

Some adhesives are mechanically squeezed out of cartridges. These are difficult to control during installation and can result in uneven bonding. They are temperature-sensitive as well, which, if installed under adverse conditions, can compromise the intended bond.

Spray foam adhesives are also available. These can bond to wet and frozen lumber. They can be applied quickly and are easy to use. The use of a spray foam gun applicator provides a more measured output, resulting in far more yield. This type of adhesive works well in wet and cold weather.

The use of high-performance panels for subflooring sometimes requires using adhesives created by the panel manufacturer, which are formulated specifically for their product. The industry standard for such adhesives is APA AFG-01 or ASTM D3498, but high-performance panel manufacturers also request that adhesive used with their products be solvent or polyurethane-based. Otherwise, the moisture repellent characteristic of high performance panels will prevent proper adhesion of adhesives that have latex or water bases.

Adhesives should be used, along with either deformed shank nails or screws, to adhere subflooring and ensure better long-term performance of a floor system. Adding glue to fastener use eliminates “shear slip” between panels and joists. It also stiffens the joist to a greater degree than using mechanical fasteners alone. When subflooring is both fastened and adhered to framing members, the composite action of two components bound together results in an increased span rating for the system. If adhesive is not used, a reduction in the span rating usually occurs. Adhering the floor, along with mechanical fasteners, also reduces nail-pops and floor squeaks.

If too much adhesive is placed on framing members, a hardened skin may form on top of the adhesive bead prior to a subfloor panel being laid down. Should that happen, that top skin will interfere with the adhesive action. For this reason, only enough adhesive should be placed at one time to adhere two subfloor panels. When placing it:

- A ¼” - ⅜” bead should be applied to all joist surfaces
- If applying it to wide surfaces or end joints, use a double bead or a serpentine pattern.
- A bead placed in a T & G panel’s groove will result in a more monolithic structure.

### Mechanical Fasteners

There are three basic types of mechanical fasteners used between subfloor panels and framing members. Smooth shank nails are the easiest to drive in, but can back out as wood dries. Ring shank or screw shank nails provide more friction to resist future pullout. Screws are the most labor intensive, but have the greatest holding power.



*So Many Choices*

The amount of force required to withdraw a fastener from a material is defined as “fastener holding power,” and directly correlates to the fastener type, combined with the density of the panel material. The denser the material, the higher the specific gravity and the more grip the wood fibers have around the surface of the fastener. The higher the panel density, or specific gravity, the more difficult for the fastener to back out. However, grip strength or fastener holding power is reduced when a wood panel becomes wet.

In this area of comparison, high-performance engineered wood subfloor panels have the greatest fastener holding power. Based on this chart, it requires a force of 23 pounds to remove a nail from ¾” thick OSB or plywood. This can be compared to the 17 pounds of force needed to remove the same nail from a high-performance panel.

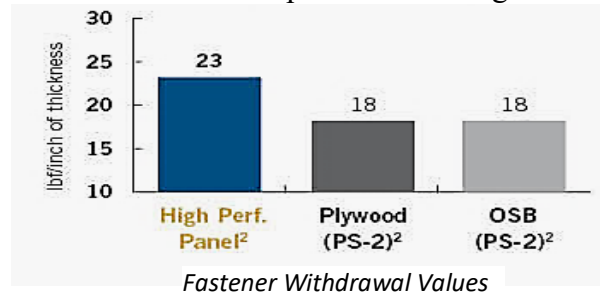

Regardless of the fastener selected, they must be properly spaced for the subflooring to do its job. The minimum distancing specified by codes is a 6” spacing along edges and 12” at intermediate supports. Panels can be purchased which are pre-printed with suggested fastener locations, to help ensure proper spacing for structural strength and bonding. These markings also help framers align fasteners with framing members below, so they properly penetrate.

Without care being taken, loose subflooring can result from installers simply missing the floor joist / trusses with fasteners while installing subfloor panels.

### Combined Adhesives and Fasteners

The industry standard is to both glue and mechanically fasten subfloor panels to framing members below. The mechanical fasteners hold the panels firmly in place until the adhesive sets up. This way, squeaks are prevented by eliminating “shear slip” between panels and joists, making the attachment stiffer than with just fasteners alone. Moreover, composite construction occurs when two separate materials are bound together so strongly that they act as though they are one homogenous component. This composite action makes two components stronger than the sum of their parts.

### **Choosing Subflooring**

With our need to make choices nearly up to the top of the system, subflooring is best defined as a surface material attached directly to the framing members. It stiffens framing members and provides a stable and uniform surface on which to place or adhere finished flooring. The subfloor receives the most wear and tear of components in a flooring system, being where the most stress occurs; the choice of materials for this component will be critical. This component must stiffen framing members, resist moisture without losing strength, resist bending between framing members, interlock with adjacent panels, remain stiff enough to prevent damage to the flooring above, remain dimensionally stable and resist fastener pull-out.

Noisy floors, among other reasons, can result from subfloors being not exactly flat, having too much deflection, still being loose in areas when finished floors are applied or a lack of adequate adhesion. We will start with getting it flat.

### Getting It Flat

After panels have been installed, the goal is to have a subfloor be both flat and level. This does not always happen, but if it does not, that must be corrected before the next component of the flooring assembly is installed.

There are four primary means to avoid subfloors being installed with deflection.

- Use direct glue down hardwood flooring, to pull subfloor panels back up to level.
- The same stiffening concept drives the solution of using thicker hardwood flooring in greater lengths.
- Blocking can be installed between joists or floor trusses at 24" O.C.
- Subfloor panels can be upgraded in quality or thickness, to obtain better grip strength for fasteners and deflect less.

### Deflection Concerns

What is also not acceptable is excessive deflection of a subfloor panel between the framing members supporting it. It is very difficult to install a high-quality finished floor over such a substrate. When it sags after finished flooring is installed, subflooring will cause compression of the surface above, with sagging or buckling of that finished floor then occurring.

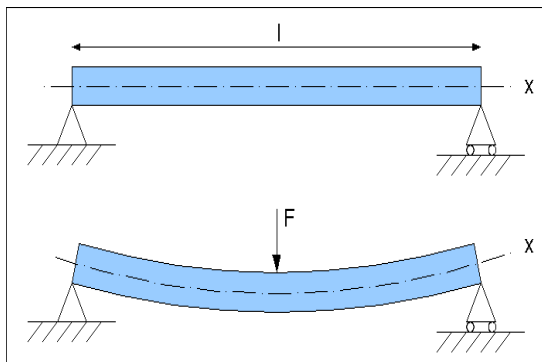

*Deflection*



*Buckling of Floor Above*

### **Review Questions:**

19. When properly applied, adhesives eliminate any \_\_\_\_\_ between framing and subfloors.
- Movement
  - Bounce
  - Applied torque
  - Moisture transfer
20. If too much adhesive is placed on framing members, \_\_\_\_\_ may form on top of the adhesive bead before subflooring can be installed.
- Surface dripping
  - Condensation
  - A hardened skin
  - The chemical equivalent of scale
21. Which mechanical fasteners provide the greatest holding power?
- Smooth shank nails
  - Screws
  - Ring shank nails
  - Staples
22. After panels have been installed, the goal is to have a subfloor be both \_\_\_\_\_ and \_\_\_\_\_ .
- Flat, level
  - Rigid, waterproof
  - Flat, waterproof
  - Waterproof, durable

### Inherent Moisture Resistance

When choosing subflooring materials that will be exposed to weather, their resistance to moisture is a critical concern. On the average, a subfloor open to the elements will receive 4-8” of rain per month, at least three times during the period of construction. To rephrase that, if your subfloor is exposed for over a month, you are likely to receive 6” of rain or snow on top of your subfloor panels. In northern climates, you will get snow and ice built up on the floor. Even under harsh weather, the higher the inherent moisture resistance of subfloor panels, the less they absorb water and the more structural integrity they retain.

Nothing is completely impervious to water, but high-performance panels promote themselves as offering the lowest moisture absorption. Plywood can buckle, warp and delaminate when it becomes wet, and OSB panels swell around their perimeter. Some manufacturers of high-performance panels claim their product offers water absorption up to 80% lower than typical plywood and up to 65% lower than typical OSB, verified by independent laboratory testing.

The amount of moisture absorbed greatly affects the subflooring performance. This is because moisture can result in swollen edges, surface degradation and strand delamination. It affects structural performance because strength, stiffness and the force needed for fastener withdrawal are all reduced with increased moisture exposure. The dimensional stability of panels changes in wet-dry cycles, as a result of repeated expansion and contraction.

### Anything Else?

Resistance to mold growth is a final reason to choose one subflooring over another. Mold needs a source of oxygen, organic food, a suitable temperature and enough moisture to grow. Not much can be done about the other three factors, but when moisture content is held below 18%, mold growth is substantially reduced. Any panel that can resist moisture absorption and keep it below that content level will also be inhospitable to mold growth.

### Subflooring Material Choices

Materials available for use as subflooring have changed over time. Historically, lumber boards were fastened on an angle across floor framing members. But in the mid 1900's, this practice gradually changed as engineered plywood became widely available. In the late 1970's, oriented strand board (OSB) was developed as a more economical structural wood panel, having capabilities similar to plywood. In 1997, high-performance wood structural panels were introduced as subflooring options, with performance greater than either plywood or OSB.

In summary, materials used for subflooring in the past have included; 1 x boards, plywood, particleboard, waferboard, OSB and high-performance panels. We will discuss a couple of these.

- Plywood

Plywood is simply multiple plies of wood veneer, often of different grades, glued together in alternating directions of grain orientation. With plies held together with glue, if that adhesive is not water-resistant, certain grades of plywood can delaminate when exposed to excessive water.

The grade assigned to plywood products depends on the amount of knots in the veneers, their grain direction and voids in the veneers:

Grade A: Appearance grade, very few defects

Grade B: Pin knots allowed, color matched

Grade C: Numerous and larger burls, pin knots, sound and smooth, color variation

Grade D: Maximum repaired defects allowed

Another designation used in labeling plywood involves the type of adhesive used. The use of "X" means exterior grade glue was used.

As an example, "CDX" as a grade marking means "Construction Grade," which further breaks down to a use of a C veneer grade on the face, a D veneer grade on the back surface, and being laminated using exterior grade glue.



*Damage from Water Absorption*

Plywood used for subflooring uses waterproof adhesives to bind plies together, with alternating layers of veneer, oriented in opposite directions. The length of time needed for waterproof adhesives to dry slows down production time in the

manufacture of plywood for subflooring. While the adhesive is waterproof, the wood plies are not, and this product can still absorb a lot of moisture, especially through exposed edges.

While plywood that has absorbed water at its edges is more prone to delamination, it is more resistant to edge swelling than OSB sheathing.

To reiterate, not all plywood is created equal. It is categorized based on application, adhesive type, the grade of its surface veneers, the grade of its core, and the number of plies determining panel thickness. The species used to make it plays an important role in how plywood will perform. The glue used in its fabrication, and how that glue reacts with moisture, will also change the characteristics of plywood.

- OSB

Oriented Strand Board (OSB) is made by gluing 3"- 4" long strands of wood in cross-oriented layers, using waterproof heat-cured adhesives. High heat and pressure are used to press strands together, forming a panel typically denser than plywood. It is a more structural version of products known as "waferboard."

Traditional or commodity OSB is manufactured using powder- or liquid-based phenol formaldehyde resins to glue strands together. These glues are somewhat susceptible to moisture, due to sodium content in the resins. Therefore, traditional OSB panels tend to be susceptible to swollen edges, surface degradation and strand delamination when they become wet.

Newer products marketed as OSB are generally denser than plywood and come in varying levels of quality labeled as commodity grade, average grade and high-performance grade.

- High-Performance Subfloor Panels

Using a higher density of both wood and resin than either commodity OSB or plywood, high-performance panels have emerged at the top of the subflooring market. These have been engineered to exceed other options in PS-2 standards for strength, stiffness and fastener holding power. Higher costs are offset by a reduction in callbacks and rework due to edge swelling, squeaks and poor finished flooring performance.

High-performance engineered subflooring is more dimensionally stable than OSB or plywood. It has greater strength and stiffness properties, due to its resin having a stronger bond with wood. The resin reacts chemically with wood's natural moisture to create better moisture resistance. Its density also ensures a better fastener-holding capability. Both sides of high-performance panels are sanded to create a consistent thickness, allowing panels to be laid flat and install easily.

High-performance panels are also engineered for greater strength and stiffness. Manufactured to be 62% stronger than OSB and plywood, 16% stiffer than plywood and 28% stiffer than OSB, they are less likely to sag, creating a higher perception of quality. The amount of bounce when people walk above them is reduced, as is the amount of deflection of the whole assembly. This results in less chance of squeaks at non-load bearing walls.

Bending strength measures how much deflection will occur prior to failure, along both the weak and strong axis. Bending stiffness measures how much sag will occur along each axis and is tested and charted by material thickness, the type of panel and the spacing of the framing materials below it. The higher the bending strength and stiffness, the less floor bounce, floor sag and movement to create squeaking and cracks in finished flooring over time.

For a manufactured panel to be labeled “high-performance,” it must perform to higher standards than PS-2 minimums. Independent testing agencies evaluate such panels for strength, stiffness and fastener holding power, compared to traditional OSB and plywood subflooring.

As previously mentioned, fastener holding power measures the amount of force required to withdraw a fastener from a material. It is directly correlated with material density. High-performance panels offer about 10% more fastener holding capability than plywood or OSB panels. In every case, fastener holding power is reduced when a wood panel is exposed to moisture.

### Installing Subfloors

Most panels used for subfloors use a tongue and groove profile, intended to lock edges of adjacent panels together and ensure they act in tandem to stresses, strengthening both. Typical OSB and plywood rely on “wedge” style T & G profiles. This makes a friction fit which allows for accumulation of stresses between the panels, with the resulting built-up stress causing noise between panels as it releases.

Tongue and groove profiles should fit snug, but not tight. Slight gaps between them should be maintained to allow for thermal expansion and contraction. High-performance panels are manufactured with an integral spacer to make it difficult to circumvent the intended spacing.

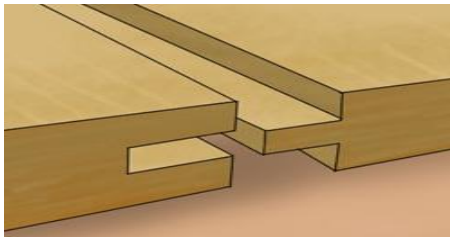

*T & G Profile*



*High Performance Panels with an Integral Spacer*

Integral spacers are designed into high-performance panels for a reason. When laborers on a job notice a slight gap has been left between panels (so they can expand and contract without damage), what we don’t want to happen is for them to take a 2x4, lay it along the outside edge of a panel and beat the 2x4 with a sledge hammer in an attempt to close the gap in the subfloor panels.

When it comes to resisting water, typical OSB and plywood panels are both susceptible to absorbing water, which can cause swollen edges or delamination. The most common fix for swollen edges is to sand the panel surface, which is somewhat problematic. The resulting sanded surface is even more prone to moisture absorption.

Testing has demonstrated that high-performance panels can offer water absorption that is up to 80% lower than typical plywood and up to 65% lower than typical OSB. Given water's many detrimental aspects, a resistance to moisture is a critical property when choosing subflooring materials. Swollen edges, surface degradation and strand delamination affect aesthetics. Structural performance is altered since strength, stiffness and fastener withdrawal decrease as moisture exposure increases. Dimensional stability is reduced in wet / dry cycles and with expansion and contraction.

Subfloor panels should always be installed so their strength axis or long edge runs perpendicular to framing members below. This results in more stability of the floor and strength. If they are installed with their strong axis parallel to framing members, this will yield a weaker system. Consequently, if a floor framing system includes framing members that run in multiple directions, some subfloor panels will likely be installed in the weaker orientation.

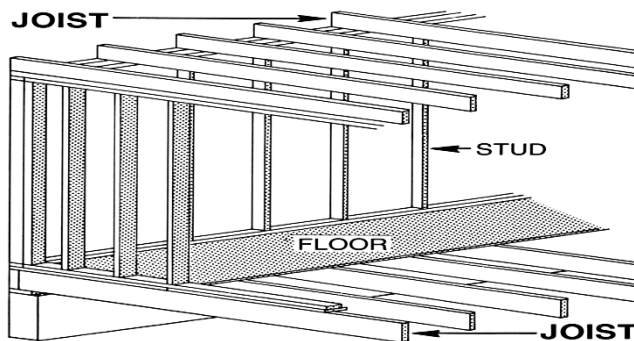

*Strength Axis Perpendicular*

### Review Questions:

23. Which type of subflooring panels claim to offer the lowest moisture absorption?
  - a. Plywood
  - b. Foam core
  - c. OSB
  - d. High-performance
24. Historically, one of the first subflooring materials was \_\_\_\_\_.
  - a. Terra cotta
  - b. Lumber boards
  - c. Hard packed earth
  - d. Primitive concrete
25. High-performance subfloor panels use a higher density of \_\_\_\_ and \_\_\_\_ than other options.
  - a. Fastener spacing, fabrication pressure
  - b. Glue, carbon content
  - c. Chemical infusion, fibers
  - d. Wood, resin

### Underlayment

The last material chosen before the finished floor is installed will be underlayment. This will be placed between subfloor and finished flooring, if required. Underlayment might also be needed to function as a sound isolation mat.

The best choice for underlayment materials, if such is needed, is the underlayment recommended by the manufacturer of the finished flooring that will be installed.

### **Finished Floor Coverings**

Finally, a finished flooring must be chosen that is compatible with the programmatic needs of the client and with the capabilities of the floor system components on which it will rest.

The long-term performance of finished flooring is directly influenced by the performance of the subfloor below it. It becomes critical to ensure the subfloor is correctly installed and suitable before applying finished flooring. Any movement in the subfloor must be isolated and minimized. Flooring like tile and hardwood is rigid, and performs best if placed on a stiff, solid base. It is a waste of money to put a high-quality finish on a poor substrate.

### General Preparation

Knowing which of the various types of finished flooring will be applied will play a part in determining the design of the flooring system below. Noisy floors can result from, among other reasons, problems with side match of finished flooring pieces, water damage resulting in pieces cupping and failure of mechanical fasteners for the finished floor.

Subflooring should be level or nearly so, before finished flooring is installed. There should be no more than ¼” deflection in 10 feet in any direction, or 3/16” deflection within 6 feet in any direction. If unacceptable variations do exist, swollen seams and high spots should be sanded and low spots filled in with a self-leveling compound.

With softer finished flooring like carpet, more floor system deflection can be tolerated. Brittle or hard finishes like tile and hardwood require a stiffer floor assembly with minimum deflection. That type of base can be realized using thicker subfloor panels, high performance subfloor panels with elevated stiffness design values, a tighter joist spacing, shorter joist spans and / or a high-strength and easy-to-use adhesive, resulting in full composite action between subfloor and framing.

Subfloors should also be checked for squeaks before finished flooring is installed. If found, the source of the movement should be located, and if possible, repaired before continuing.

## Basic Types of Finished Flooring

In general, the most popular finished floor coverings are as follows.

- Luxury Vinyl Tile (LVT) - This relatively recent addition on the market was developed by manufactures for aesthetics and low cost. Most LVT manufacturers provide installation instructions, with some even offering recommendations for underlayment.
- Resilient (vinyl, linoleum, cork, rubber) - Vinyl composition tile (VCT) is an older product that can usually be obtained for a lower cost than LVT. Vinyl ranges from impermeable to semi-impermeable. Cork and linoleum are typically semi-permeable. Rubber is generally impermeable. When it is used below a resilient flooring, a wood panel underlayment (e.g., ¼” plywood) is semi-permeable.
- Laminate (multi-layer synthetic) - These plastic-coated composition planks range from impermeable to semi-permeable. Underlayment is commonly an impermeable foam.
- Hardwood Floors - There are multiple manufacturers who supply these, along with installation instructions. When laid, these floors are generally semi-permeable, so moisture can escape up through them and subfloors can dry. The common Grade D asphalt-saturated Kraft paper underlayment often used beneath them is also semi-permeable.
- Engineered Hardwood Floors - These are generally of man-made wood or manufactured boards, created by binding or fixing strands, particles, fibers or veneers of wood together with adhesives, forming a composite material. They are used much as are hardwood products.
- Carpet - This is available in many compositions and backings, with most using a pad underlayment. The carpet backing may or may not be permeable. Pads also range from impermeable to permeable. So care must be taken that moisture does not wind up trapped.
- Tile – Ceramic and other similar natural products are made of stone, clay or porcelain. Almost all require the use of underlayment and range from impermeable to semi-permeable. Of the underlayment possibilities, cement board, mortar and grout are commonly semi-permeable, Grade B asphalt-laminated Kraft paper is semi-impermeable and polyethylene membrane is impermeable.



*Vinyl Tile*

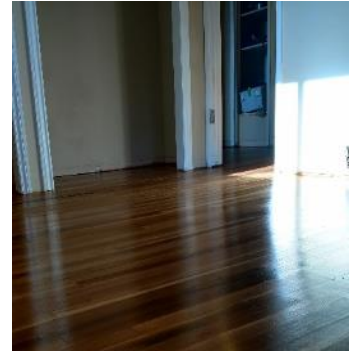

*Carpet*



*Ceramic Tile*

## When Permeability Matters

- Given the propensity in hot, humid climates for moisture to build up in crawl spaces and be driven upward:
  - Do not place vapor impermeable flooring over vapor permeable insulation.
  - Vapor impermeable insulation allows a greater choice of flooring that can be used above it, but if it is combined with vapor impermeable flooring, a double vapor barrier could be formed that would trap moisture from a plumbing leak or overflow.
- Like any other weak link, whatever piece of the flooring assembly that is the least vapor permeable will be the one controlling the ability of the whole assembly to dry upward.
- To complicate choosing floorings for moisture control, many manufacturers do not publish perm ratings for their products.
- If vapor impermeable flooring is used in wet areas like bathrooms, and is placed over vapor permeable insulation in the floor, what will occur is not certain. Trapped moisture may be re-distributed and it will be difficult to tell whether moisture at the subfloor came from spills, materials that were installed wet or from seasonal accumulation.

### Specific Flooring Installation Tips

- **Hardwood Flooring**

Hardwood flooring should be installed with cleats, nails or staples, perpendicular to the floor joists and over 15# felt and red rosin paper. This installation will minimize cupping and bowing of individual boards and bowing of the entire floor, should multiple pieces be trying to expand from moisture absorption. Using high-performance subfloor panels can also be beneficial if hardwood will be installed above them. Their increased fastener withdrawal resistance and increased resistance to moisture can also minimize the risk of cupping and swelling.

With finished flooring, it is important to let flooring materials acclimate before installation, especially with hardwood. Subfloor panels should be allowed to dry to an appropriate moisture content. Despite subflooring looking dry on its surface, it is prudent to check the internal moisture content before applying finished flooring, especially hardwoods. A pin-style moisture meter can be used for this purpose. With narrow strip hardwood flooring the moisture difference between subfloor and hardwoods should be no more than 4%. Using wide plank hardwood, the difference should be no more than 2%. For all hardwood installation, the subfloor should have a moisture content no more than 12%. A moisture meter should be used to check the moisture content of both the subfloor and the hardwood. For the best results, the building's HVAC system should be operational prior to installation, to help acclimatize the hardwood materials to the ambient environment

- **Tile Flooring**

Ceramic tile should never be installed directly over wood subfloor panels. Although a proper stiff and strong subfloor should have been installed, underlayment is also needed before setting tile in place. Underlayment can be of materials like plywood, cementitious backer board or an uncoupling membrane. That underlayment will need to be fastened securely and permanently to avoid cracking of the finished floor. Regardless of which of the many choices in tile

underlayment is installed, it is very important to follow the manufacturer's directions while choosing and placing it.

Ceramic tile floors will crack if there is movement or sagging within the subfloor below. This makes it important to choose subfloor panels that can resist the effects of moisture.

### General Thoughts on Finished Flooring

- Match subfloor to finished floor.
- OSB and plywood are sufficient subflooring panels for carpet.
- OSB and plywood are sufficient subfloor panels for sheet vinyl, but proper underlayment must still be used before installing the vinyl.
- If the finish is prone to cracking, make sure the subfloor will neither deflect nor move. Brittle finishes, like tile and hardwood, require minimum subfloor deflection. This can be accomplished by using thicker subfloor panels, high-performance subfloor panels with higher stiffness values, tighter joist spacing, shorter joist spans and an easy-to-use adhesive to ensure full composite action between subfloor panels and the framing below them.

## **APPLYING DESIGN FROM THE GROUND UP**

There is an old saying that failing to plan is really just planning to fail. There are typical combinations of systems and materials that can act to trap moisture, allowing organic growth to occur. Most flooring professionals have learned to recognize these as upcoming sources of callbacks.

### **Problematic Design Scenario**

This is one such typical scenario.

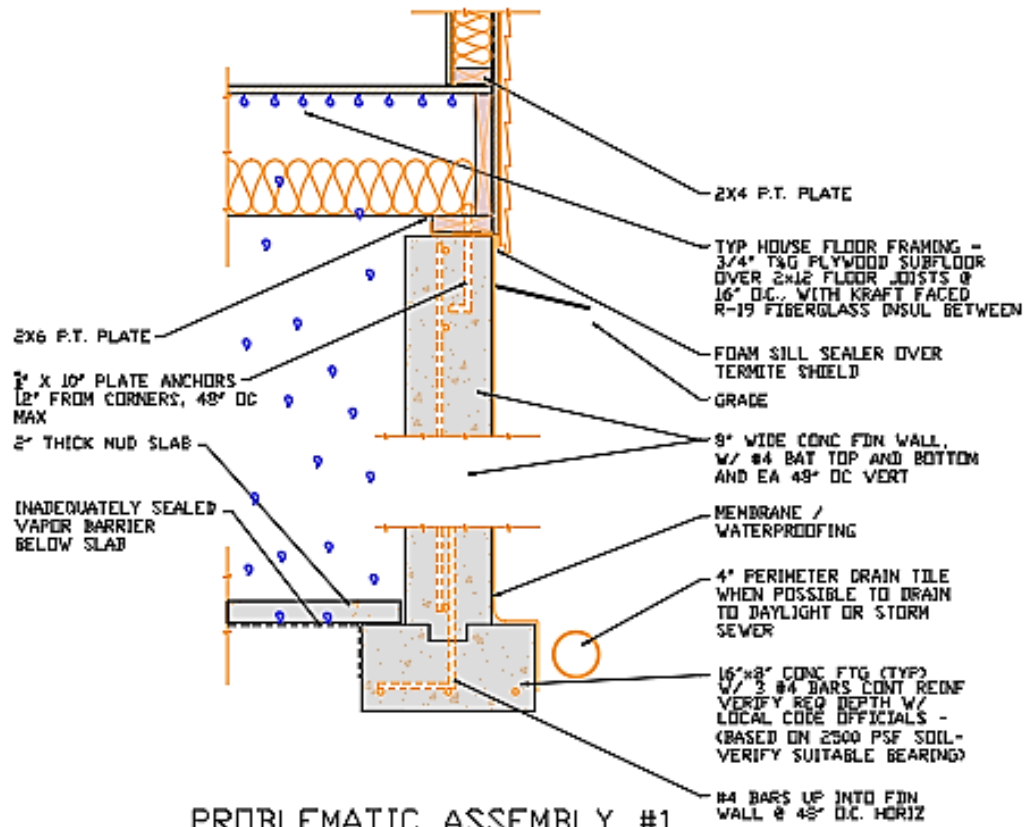

In numerous locations in our country, groundwater levels can seasonally rise above the level of crawl space floors. This will create groundwater pressure, driving moisture up from below, seeking to equalize its level. If the vapor barrier below the mud slab is not properly sealed, and most are not, moisture will enter the crawl space from below and migrate upward as vapor. If the side tabs on Kraft-faced insulation are not properly fastened to each joist, and they often are not, the gaps created will allow moisture migrating upwards to enter and remain in the insulation, fostering organic growth.

This assembly would be best served by including vents and allowing air circulation to carry migrating moisture back outside. Better yet would be the use of exhaust fans to accomplish the same task, triggered by rising humidity levels.

### Floor Assemblies in Hot Humid Climates

Hot humid climates can be rough on buildings.

This climate scenario is also one of the most damaging to the long-term performance of flooring systems. This is because ever-present heat evaporates ever-present moisture and drives it upward into the floor system. Flooring assemblies used in these climates can benefit from careful consideration of, and possible changes to, materials, that will measurably improve their performance in specific scenarios.

- The first scenario normally uses vapor permeable insulation and flooring. It consists of wood joist framing over a crawl space, with unfaced fiberglass batt insulation between joists and permeable subflooring and flooring on top.
  - Kraft-faced or foil-faced batt insulation, secured with staples, would improve the control of vapor.
  - If open crawl spaces are used, it would be prudent to also install rigid sheathing below the joists to protect the insulation
  - If the batt insulation were changed to vapor permeable open cell spray foam, it would allow vapor through, but help seal against air infiltration.
  - Since vapor will be migrating up and through framing and subfloor components, it would be best to make the framing and subfloor of treated wood that resists moisture.
  - Finished flooring used above the subfloor should be vapor permeable, like carpet and permeable carpet pad.
  
- The second scenario uses vapor semi-impermeable insulation and semi-permeable flooring. It consists of wood I-joist framing over a crawl space, with closed cell spray foam insulation between joists and semi-permeable subflooring and flooring on top.
  - The closed cell spray foam also seals against air penetration.
  - The bottom of the I-joists can be sheathed to protect them against moisture.
  - Semi-permeable flooring will still allow vapor to escape upward. One choice would be hardwood flooring over asphalt saturated Kraft paper, over a ¼” plywood underlayment.
  - Installing a thermal or ignition barrier below the joists might be a good idea.
  
- The third scenario uses vapor impermeable insulation and semi-impermeable flooring. It consists of wood I-joist framing over a crawl space, with foil-faced polyisocyanurate rigid foam insulation on the bottom of the joists and semi-impermeable subflooring and flooring on top.
  - The bottoms of the I-joists are protected from moisture in this setup.
  - The perimeter rim area should be air sealed and insulated.
  - All exposed edges, seams, and penetrations of the foil facing should be sealed with foil tape.
  - The rigid foam should be protected by placing a protective board sheathing or a thermal barrier over it.
  - Substituting foil-faced, nonperforated fiberglass batts, stapled to the bottom of the joists and protected by applied sheathing, may also be acceptable.
  - Flooring should be semi-impermeable to allow any moisture that penetrates to escape upward. One choice would be ceramic tile, mortar and cement board over asphalt laminated Kraft paper over a ¼” plywood underlayment.

As can be seen from just these few isolated examples, carefully weighing choices in chosen components of foundation to floor assemblies can yield long-term benefits.

## **Experimental Study**

Real life data is always better than hypothetical assertions. Proof of performance is always more valuable than estimates of the same. This is why this course includes the data found below.

The information that follows was based on a cooperative research project conducted by the U.S. Department of Agriculture's Forest Products Laboratory and the Louisiana State University Agricultural Center. The study was supported by the Forest Products Laboratory, APA-The Engineered Wood Association and the Southern Pine Council. The study examined the effects of insulating raised floors in hot, humid climates.



*Flooded Crawlspace*

Twelve homes were monitored in flood hazard areas in Louisiana. Eleven were constructed with open pier foundations, and one with a wall-vented crawl space having a vapor-retarding soil cover. Those with open crawl spaces did not have soil covers. Data was recorded with sensors placed indoors, outdoors and in crawl spaces, measuring air temperature and humidity. Moisture content and subfloor temperature were measured twice a month for a year, from October to October.

There were six different insulation systems involved: 2"-thick, rigid, foil-faced polyisocyanurate foam below floor joists, 2"-thick closed cell sprayed polyurethane foam below the subfloor, 2.6"-thick medium density open cell sprayed polyurethane foam under the subfloor, 3.4"-thick low density open cell sprayed polyurethane foam below the subfloor, 3.4"-thick low density open cell sprayed polyurethane foam below the subfloor with vapor retardant paint coating added, and 6.25", Kraft-faced fiberglass batts installed between floor joists with the Kraft facing up against the subfloor, supported by metal rods. In each instance, the insulation was rated with an R-value of R-13, except the batt insulation, which was rated at R-19.

The following general observations were made.

- For all the homes, when air conditioners were running, the vapor drive was predominantly inward. When air conditioners were not in operation, there was little difference between indoor and outdoor water vapor pressure.
- Air temperature in the open crawl spaces was very close to the outdoor air temperature, being just slightly tempered by the cooler temperature of the indoor air above them.
- In the one home with the wall-vented crawl space, the air temperature in the crawl space was considerably warmer or cooler than the outdoors, being more affected by the different temperature of the living space above.
- Water vapor pressure inside all crawl spaces was roughly the same as outdoors.
- Moisture content in plywood or solid wood subfloors varied based on the season of the year and the indoor temperatures being maintained.

Subfloor moisture content was found to be generally higher in the summer and lower in the winter. This resulted from wood subfloors being cooler than the crawl space in the summer and warmer than it during the winter months. Vapor drive was moving moisture toward the colder regions and materials. Such differences in temperature increased when insulation was placed between the subfloor and the crawl space.

As we'll describe more fully in what follows, when certain types of flooring were combined with a certain type of insulation, the colder the indoor temperature maintained by an air conditioner, the higher the moisture content found in the subfloor. This cause and effect has been known for many years.

Impermeable floor finishes like vinyl, that prevent inward drying of the surface below, were those most likely to result in higher MC in subfloors. Carpet is much more permeable to vapor. Hardwoods finished with polyurethane and ceramic tile fall somewhere between those extremes.

Permeable insulation materials also resulted in higher subfloor moisture content. They allowed moisture to migrate upward into the subfloor. Two good alternatives to slow this down are foam board faced with aluminum foil (impervious) and closed cell spray foam insulation (semi-impervious). Both prevent such summertime moisture accumulation in subflooring. The foam board faced with foil is sometimes applied to the bottoms of joists with all seams taped, to resolve issues where previously-installed open cell foam or batt insulation is still allowing excessive moisture content to accumulate in subfloors. The trick is to first make sure materials above the foil are not impervious and a moisture sandwich is not being created.

Open cell spray foam and batt insulation are much more permeable and do little to prevent accumulation. Batt insulation, though doing little to prevent passage of vapor, performs better if it incorporates Kraft paper facing with the paper installed right below the subfloor. The Kraft paper does become more permeable as relative humidity rises, which is pretty much part of the description of a hot, humid climate.

The largest moisture accumulation was noted where moisture vapor moved upward through permeable insulation, but was then trapped in the subfloor by impervious flooring through which it could not further migrate.

When trying to reduce MC in subfloors, besides installing impervious insulation below joists, another simple fix used is to remove impervious floor coverings and replace them with some that are permeable.

One last way to manage moisture accumulation in subfloors in hot, humid climates simply involves using thermostats. In some instances, air conditioning temperatures were set as high as possible. Houses in the study with summertime settings of 78 degrees or warmer showed no problem with moisture in the subfloor, regardless of the type of insulation used. Discomfort in these warmer homes was alleviated with the use of ceiling fans and stand-alone dehumidifiers.

## **General Design Recommendations**

The following is a summary of recommended design considerations to strengthen the long-term performance of foundation to floor assemblies, starting from the bottom up.

### Spaces below Buildings

- Initial grading, positive drainage, foundation damp-proofing, capillary breaks and flashing are all tools that can be used to exclude rain and groundwater from basements and crawl spaces, even during construction.
- Control vapor migration from the crawl space, up through the floor, with effective air sealing of floor penetrations, rim areas and insulation seams.
- Select treated floor framing and subfloors to improve moisture resistance, especially in vented crawl spaces having permeable insulation and floor joists that are exposed below the insulation.
- If a crawl space is closed and conditioned, permeability of components will not matter.

### Choosing Floor Components in Hot, Humid Climates

- Choose insulation needed to meet building code or above code energy requirements.
- Vapor impermeable or semi-impermeable insulation will limit vapor migration up into the floor assembly.
- Under-floor insulation should not make inspection for pests difficult.
- Do not install vapor impermeable flooring and underlayment over vapor permeable insulation.
- If possible, use vapor permeable interior flooring and underlayment to allow moisture to dry upward, into the interior.

### HVAC Systems to Control Indoor Humidity

- Do not over-size air conditioning systems or they will not run often enough to dehumidify spaces.
- Install a central or stand-alone dehumidifier to help control relative humidity in swing seasons.
- Install and seal A/C ducts in conditioned space, as ducts with leaks can draw humid air inside or depressurize the house and increase infiltration.

### General Building Recommendations

- Install all products in accordance with manufacturers' specifications, building codes and specifications from licensed design professionals involved.
- With components where it is suitable, specify an easy-to-use and high performance subfloor polyurethane spray-foam adhesive, used in combination with screws or deformed nails, to fasten subflooring to framing.

### Occupant Use

- Raise indoor air conditioning to warmer levels to decrease moisture accumulation within floors.
- Use bath and kitchen exhaust fans to control sources of humidity.
- Don't "super-cool" the house to dehumidify it. That will increase humidity in the subfloor.

### **Summarizing How to Start From the Bottom**

When designing floor systems, the best approach is one that is systematic. It begins with consideration of the project climate and moves all the way through selection of the finished flooring materials.

As with any other design problem, flooring design includes analysis of the principles, codes, construction methods and available products that will affect the desired outcome. Risks are acknowledged and choices are made to lower those to acceptable levels. In other cases, choices are made to prevent foreseen problems from even occurring.

History provides answers to many of our questions. We have documented how moisture travels through materials used in common flooring assemblies, and the results of that movement. Most of this data has been provided by real world experience.

We have also addressed many problems with engineering. For example, I-joists and floor trusses have been created to address issues of stability, shrinkage and field modifications to framing members made of natural wood. Another significant example is the relatively recent creation of engineered high-performance panels for use in subflooring. These have been created to address issues of dimensional stability, moisture resistance, maintaining spacing for expansion, bending strength, stiffness, pull-out strength of fasteners and ease of installation.

We can predict with a fair amount of certainty how and where moisture migration will occur, based on climate and site conditions. This will influence the type of foundation chosen and components within them to prevent or redirect the passage of water. Properly-sized floor framing components will exceed code minimum deflection requirements and minimize future movement in the whole system. Then, based on expected moisture migration, insulation systems and subflooring and flooring products can be selected to either resist or permit the expected migration of moisture, as well as reacting to the anticipated weather exposure during construction. A final step is to develop good details of how components will work, be connected together and stay that way.

Such a thorough approach is nearly certain to meet high expectations for a solid, quiet flooring base, both our own and those of our clients.

## **STARTING FROM THE BOTTOM**

REVIEW QUESTIONS AND EXPLANATIONS

1. The effort in creating a successful flooring assembly begins with \_\_\_\_\_ .
  - a. **An analysis of water movement on-site**  
*( If a building is placed directly in the path of moving site water, moisture will always be a problem )*
  - b. Recognizing the permeability of chosen subflooring panels  
*( An important step - later )*
  - c. Installing two sump pumps, one as a backup system  
*( Only if there is a reason to anticipate a serious problem )*
  - d. The choice of a proper adhesive between floor and subfloor  
*( An important step - later )*
  
2. Moving air carrying water vapor with it is termed as \_\_\_\_\_ .
  - a. Air infiltration leakage  
*( Right concept, but not the same words used in the trades )*
  - b. Subservient air movement  
*( Okay – that’s just weird )*
  - c. **Water vapor migration by way of air leakage**  
*( Moving air carries humidity trapped within it to its new location )*
  - d. Initial absorption with delayed release  
*( Sounds like it must mean something, but no dice )*
  
3. Improper storage of materials stockpiled on-site fails to properly protect them from \_\_\_\_ .
  - a. After hours theft  
*( While this may be true, it has nothing to do with moisture other than tears of anger )*
  - b. **Moisture exposure and absorption**  
*( Moisture allowed to accumulate in materials exposed on-site will wind up built into the structure )*
  - c. Damage from insect infestation  
*( Again, nothing to do with moisture )*
  - d. Improper installation due to warping  
*( This may wind up being true, but not in all cases )*
  
4. The use of vapor barriers is \_\_\_\_\_ by the IRC, in floors in climate zones 1, 2 or 3.
  - a. Encouraged, but not required  
*( This is not in the code )*
  - b. **Neither required nor prohibited**  
*( Exterior-facing materials are often used in these zones that already act as a vapor barrier; a second one should not be added )*
  - c. Deemed an unnecessary expense  
*( Those who pass codes really don’t care what compliance costs )*
  - d. Enough reason to red tag construction  
*( Ah, but for installing them or not installing them? )*
  
5. \_\_\_\_\_ is where requirements can be found for floor insulation, air barrier and air sealing.
  - a. Climate zone maps

*( These maps are actually just to delineate climate zones )*

b. ASHRAE climate indicators

*( To the best of my knowledge, there are no such things )*

c. Occupancy classification tables

*( Floor insulation, air barrier and air sealing have very little effect on occupancy )*

d. **Table N1102.4.1.1**

*( That is the correct code section )*

6. Reducing what in a building will help to lower interior humidity loads?

a. **Open water sources**

*( Showers, plants, saunas, etc. pump humidity into the internal environment on an ongoing basis )*

b. The number of single user toilets

*( Only if water closets in these get flushed more often than those in gang toilets )*

c. Landscaping sprinklers next to structures

*( The key word in the question is interior )*

d. Solar heat gain contributing to evaporation

*( Only if the sun is shining directly on an open water source )*

7. To combat the possibility of water vapor condensing inside the cavity of a building assembly, HVAC systems can be set to maintain indoor humidity \_\_\_\_\_ .

a. **Between 30-50%**

*( This has proven to be the optimal range to prevent that )*

b. Between 0-5%

*( Not the humidity level proven to be optimal )*

c. At the same level as that outside

*( Not the humidity level proven to be optimal )*

d. At a dew point higher than 64 degrees

*( Dew point can vary with humidity remaining the same )*

8. To protect wood products from rot or decay, keep moisture content below \_\_\_\_\_ .

a. 42.5%

*( Not the moisture content needed to prevent growth )*

b. **20%**

*( This is the minimum moisture content that supports the growth of mold )*

c. Obvious saturation levels

*( No real idea what this even means, related to the question )*

d. 11%

*( That would do it, but it can still go higher )*

9. Which of the following is not an interior parameter affecting floor assembly performance?

a. Foundation considerations

*( This is in the course )*

b. Moisture and vapor control measures

*( This is in the course )*

c. **A back-up floor framing system**

*( This is a completely fictitious answer )*

d. Grading of the building site

*( This is in the course )*

10. In areas prone to flooding, raised floor foundations should \_\_\_\_\_ the space below the building.

a. Be set up to preheat air entering

*( Heat won't actually repel flood waters )*

b. Float above a seal sealer on top of the foundations of

*( Foundations don't tend to float )*

c. **Allow water to move through and out of**

*( The best way to keep moisture from migrating upward is to let it pass through and exit the foundation space )*

d. Require the use of impervious materials in all

*( That only matters once flood waters get to them )*

11. Which of the following is not one of the three primary types of crawl spaces?

a. Open crawl space

*( This is one of the three mentioned )*

b. Wall-vented crawl space

*( This is one of the three mentioned )*

c. Closed crawl space

*( This is one of the three mentioned )*

d. **Pier and pad crawl space**

*( This is not actually a standard definition for a crawl space )*

12. Which of the following is not recommended for use in areas prone to flooding?

a. Open crawl space

*( Only one is mentioned as being not recommended and this wasn't it )*

b. Wall-vented crawl space

*( Only one is mentioned as being not recommended and this wasn't it )*

c. **Closed crawl space**

*( Water will get inside these, but not be able to exit, a sure recipe for increasing humidity )*

d. Pier and pad crawl space

*( Only one is mentioned as being not recommended and this wasn't it )*

13. The lowest vapor barrier is sometimes placed \_\_\_\_\_ .

a. Below a basement or crawl space slab

*( When placed on grade below a slab, it is usually sealed 6 mil Visqueen )*

b. Over the earth in a crawl space

*( Sometimes 6 mil Visqueen is placed on grade and held down with pea gravel to keep it from moving )*

c. **Both of the above**

*( This answer is taken directly from the material; either place is a good location for an initial barrier )*

d. Neither of the above

*( Both are correct )*

14. One way a higher vapor barrier is created is when \_\_\_\_\_ .

a. Adhesive is used on all subfloor and framing surfaces to adhere insulation

*( Adhesive is not known to act as a vapor barrier )*

b. **Moisture cannot penetrate upward through impervious subflooring**

*( Impervious means moisture cannot pass through it )*

- c. Exhaust fans evacuate humid air before it can rise to the level of the framing

*( This is a solution to humidity levels, but has nothing to do with a vapor barrier )*

- d. It is installed, despite specifications to the contrary

*( It can also be installed in compliance with bad specifications )*

15. Which of the following is not among the criteria used to choose floor framing members?

- a. How much deflection can be tolerated

*( This is one of the criteria mentioned in the course )*

- b. Available credit lines at local suppliers**

*( Budget is not a good reason for material choices in areas subject to damage )*

- c. Spans to be bridged

*( This is one of the criteria mentioned in the course )*

- d. Products readily available

*( This is one of the criteria mentioned in the course )*

16. Variations in natural lumber framing members pretty much forces sizing of individual members to be based on \_\_\_\_\_ .

- a. Worst possible scenarios**

*( The theoretically weakest member must be capable of carrying the same load as the theoretically strongest, so member placement will not be critical )*

- b. Largest available sizes

*( Sizing decisions are not made based on supply, but on engineering )*

- c. Cross sectional area, rather than height

*( Sounds good in theory, except that structural capabilities can vary widely between members with the same cross sectional area, but different dimensions )*

- d. The number of visible flaws

*( Those are usually just warning sizes to examine the framing members a bit more closely )*

17. The 2015 IECC Code prescribes a minimum \_\_\_\_\_ R-value for floor insulation in climate zones 5 and 6.

- a. R-13

*( This one is not the recommended R-value )*

- b. R-19, but it must be closed cell

*( This one is not the recommended R-value )*

- c. R-19

*( This one is not the recommended R-value )*

- d. R-30**

*( This comes straight from the code )*

18. Closed cell sprayed polyurethane foam, applied just below the subfloor, is moisture-resistant, but still \_\_\_\_\_ .

- a. Leaves framing members unprotected to absorb vapor**

*( It is being applied to the bottom of the subfloor. The framing members are still exposed below that. )*

- b. Can curl away from surface edges over time

*( I have no idea if this is true )*

- c. Needs inspected afterward to ensure no gaps were created

*( This is a good idea but has no bearing on the fact the framing members are still exposed )*

d. Needs holes drilled through it to permit free moisture migration  
( Uh .... Kind of defeats the purpose of applying it )

19. When properly applied, adhesives eliminate any \_\_\_\_\_ between framing and subfloors.

a. **Movement**

( If all surfaces are in contact during adhesion, neither will move independently of each other later )

b. Bounce

( This is a kind of movement; the first answer is more all-inclusive )

c. Applied torque

( I'm not real sure how to apply torque to a floor, without precise use of a tornado or large dozer )

d. Moisture transfer

( Adhesive is not a vapor barrier, in and of itself )

20. If too much adhesive is placed on framing members, \_\_\_\_\_ may form on top of the adhesive bead before subflooring can be installed.

a. Surface dripping

( No mention was made of foam adhesive dripping )

b. Condensation

( There is no temperature difference to trigger condensation )

c. **A hardened skin**

( The top surface of the bead will dry and will not properly adhere later )

d. The chemical equivalent of scale

( I have no idea what that means )

21. Which mechanical fasteners provide the greatest holding power?

a. Smooth shank nails

( Pull-out strengths are based on lab tests and this fastener did not qualify as the greatest )

b. **Screws**

( The threads create multiple flanges that resist withdrawal )

c. Ring shank nails

( Pull-out strengths are based on lab tests and this fastener did not qualify as the greatest )

d. Staples

( Pull-out strengths are based on lab tests and this fastener did not qualify as the greatest )

22. After panels have been installed, the goal is to have a subfloor be both \_\_\_\_ and \_\_\_\_ .

a. **Flat, level**

( These qualities are both important for a good subsequent installation of the finished flooring )

b. Rigid, waterproof

( Both are good qualities, just not the ones referenced in the course )

c. Flat, waterproof

( Both are good qualities, just not the ones referenced in the course )

d. Waterproof, durable

( Both are good qualities, just not the ones referenced in the course )

23. Which type of subflooring panels claim to offer the lowest moisture absorption?

a. Plywood

( The marketing materials for high-performance panels offer lab tests that say otherwise )

- b. Foam core  
( This board made for presentation backing material makes an exceptionally poor subfloor material )
- c. OSB  
( The marketing materials for high-performance panels offer lab tests that say otherwise )
- d. **High-performance**  
( Their literature says so )

24. Historically, one of the first subflooring materials was \_\_\_\_\_ .

- a. Terra cotta  
( Maybe a finished flooring material, but not a subfloor )
- b. **Lumber boards**  
( These were usually applied diagonally across the framing members )
- c. Hard packed earth  
( This is not typically placed over framing members )
- d. Primitive concrete  
( Possibly, but this is not referenced in this course )

25. High-performance subfloor panels use a higher density of \_\_\_\_ and \_\_\_\_ than other options.

- a. Fastener spacing, fabrication pressure  
( This question is specifically answered in the course as to the reason such panels are high-performing; this is not that answer )
- b. Glue, carbon content  
( This question is specifically answered in the course as to the reason such panels are high-performing; this is not that answer )
- c. Chemical infusion, fibers  
( If chemicals are infused, unknown side effects could potentially lead to the death of the inhabitants living above it. Should one of those be the person who would finally bring about world peace in the future, destroying that child now would actually result in the continued slaughter of millions in the foolish games we call wars. Better to just omit chemical infusion from the subflooring materials we use. )
- d. **Wood, resin**  
( The increase in both tends to make the product heavier and do a better job spanning distances between framing members )