

ASSEMBLY INSTRUCTIONS

SLOTWALL SPINNER UNIT

M8100BH BEECH
M8100BK BLACK
M8100WH WHITE

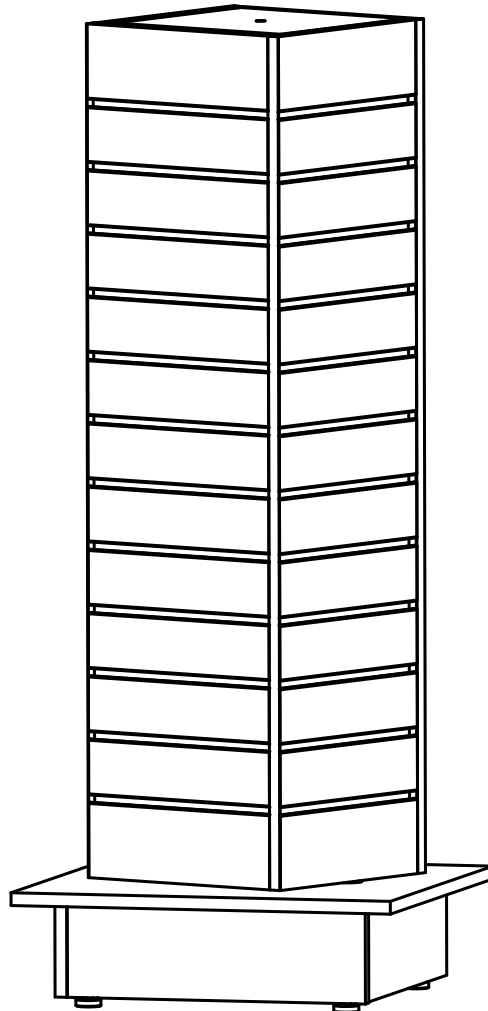

S f
f S **SHOP for SHOPS**

Telephone 03 9417 3592 Facsimile 03 9419 3476

Email sales@shopforshops.com

Website www.shopforshops.com

PARTS LIST

SLOTWALL SPINNER UNIT

1 X base

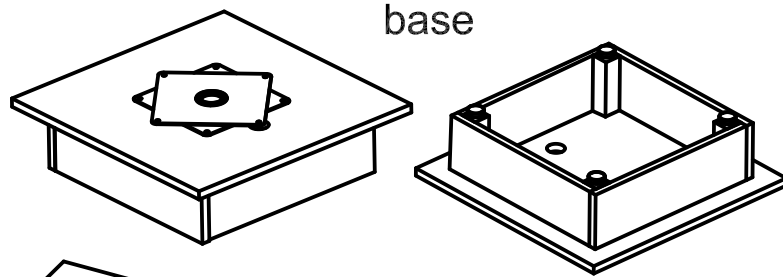

base

4 X side panels

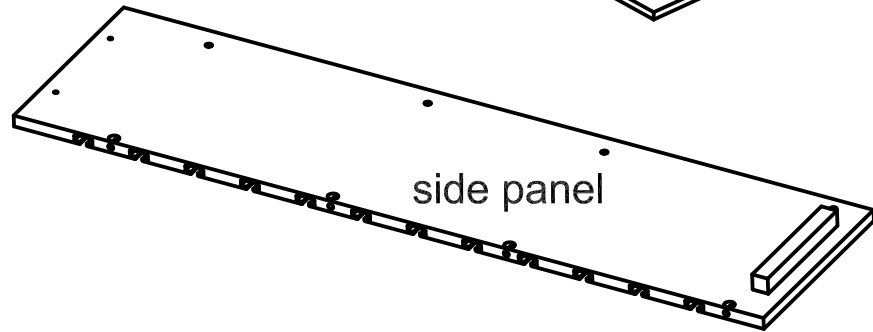

side panel

1 X top panel

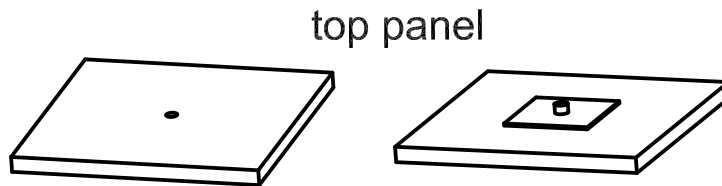

top panel

1 X bottom panel

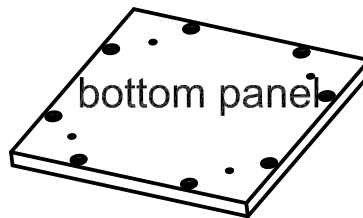

bottom panel

A.



B.

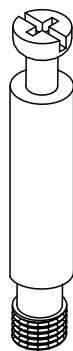

C.

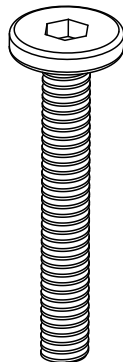

D.

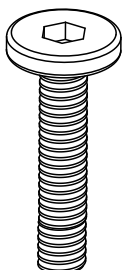

E.

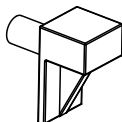

F.

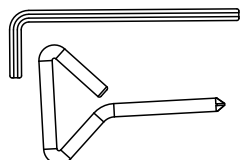

A. 16 X cam locks

B. 16 X connecting bolts

C. 8 X 1/4"-20x35 screws

D. 4 X 1/4"-20x20 screws

E. 8 X top panel fixing pins

F. 1 X allen key and 1 X cross key

1 Install 4 X connecting bolts and 4 cam locks into two side panels.

Put the other side panels and secure all cam locks

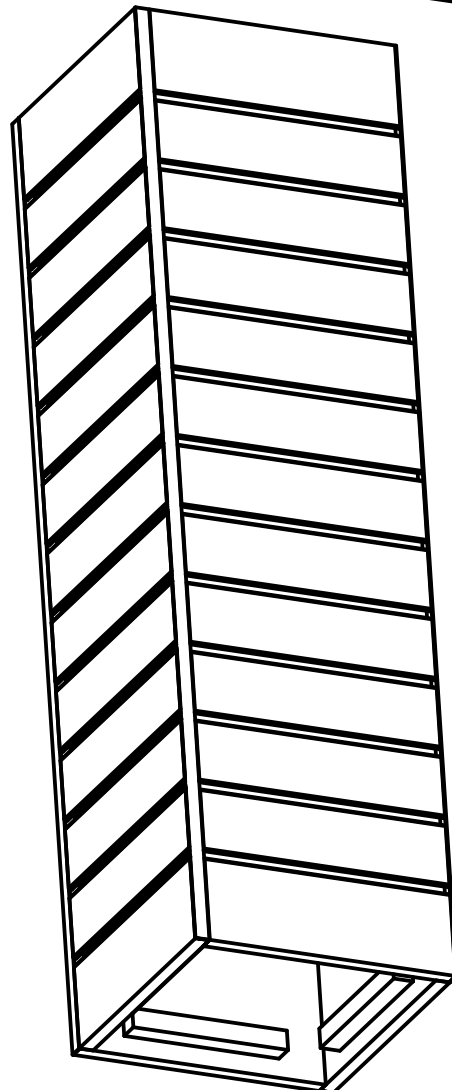
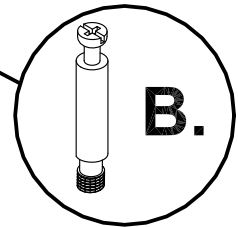
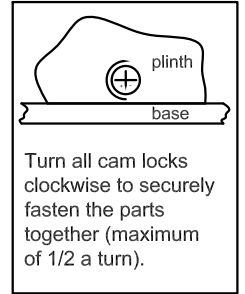
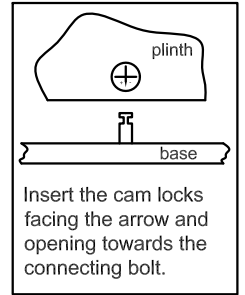
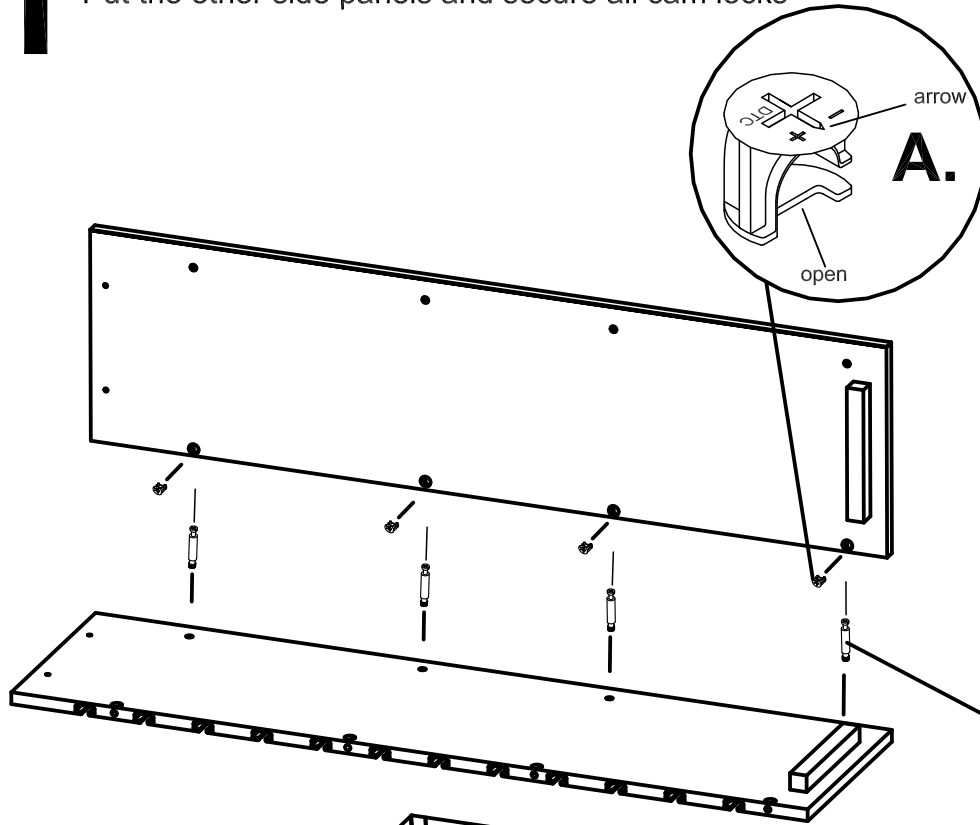

2

Install 8 X 1/4"-20x35 screws into side panels

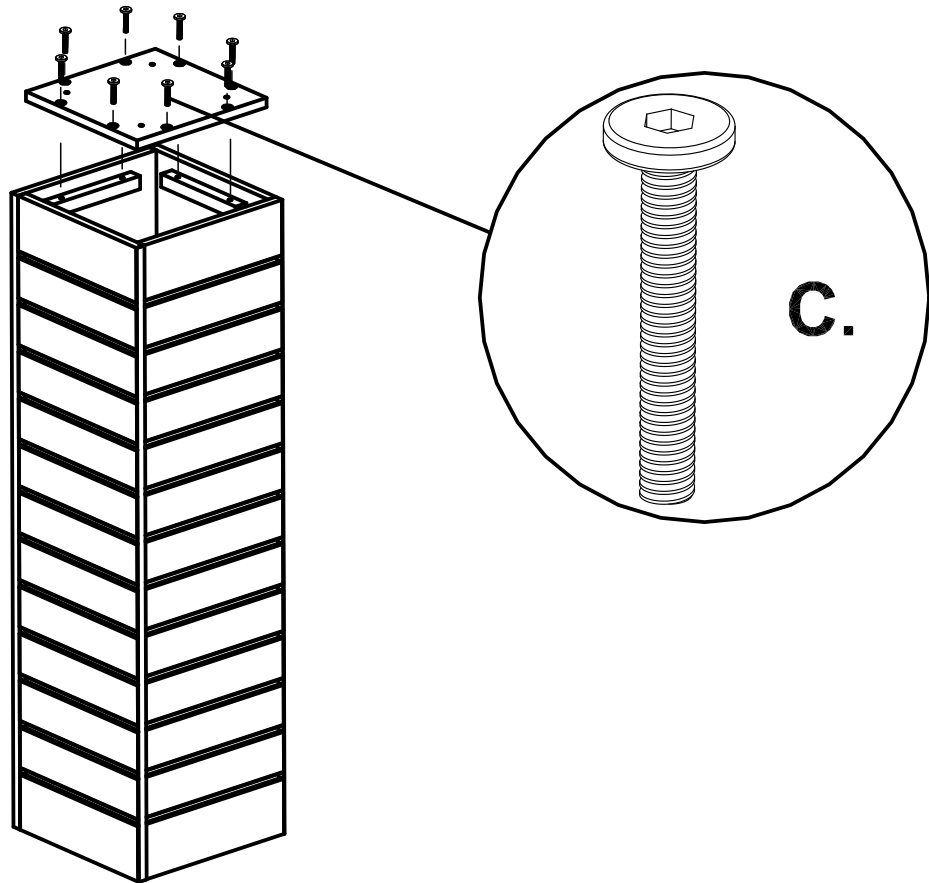

3

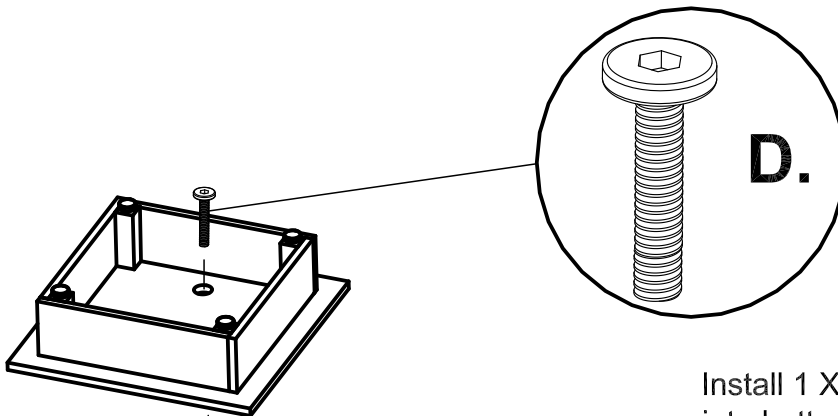

Install 1 X 1/4"-20x20 screw into bottom panel then locked

Turn the base clockwise (1/4 a turn) to fix the other screw then locked

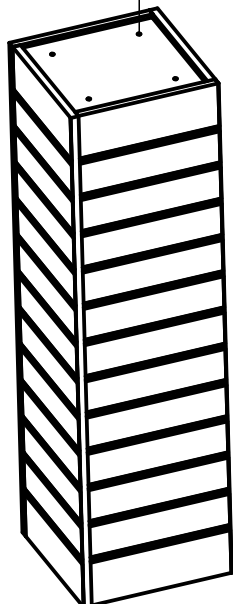

TOP VIEW

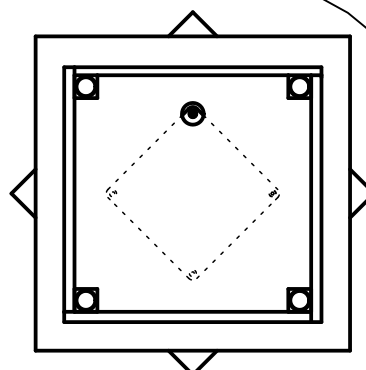

4

Install 2 X top panel fixing pins onto each side panel

Put on the top panel

