

SLIDING DOOR KIT WITH LOCK TO SUIT F4018 COUNTER MDF

F4019BH BK WH

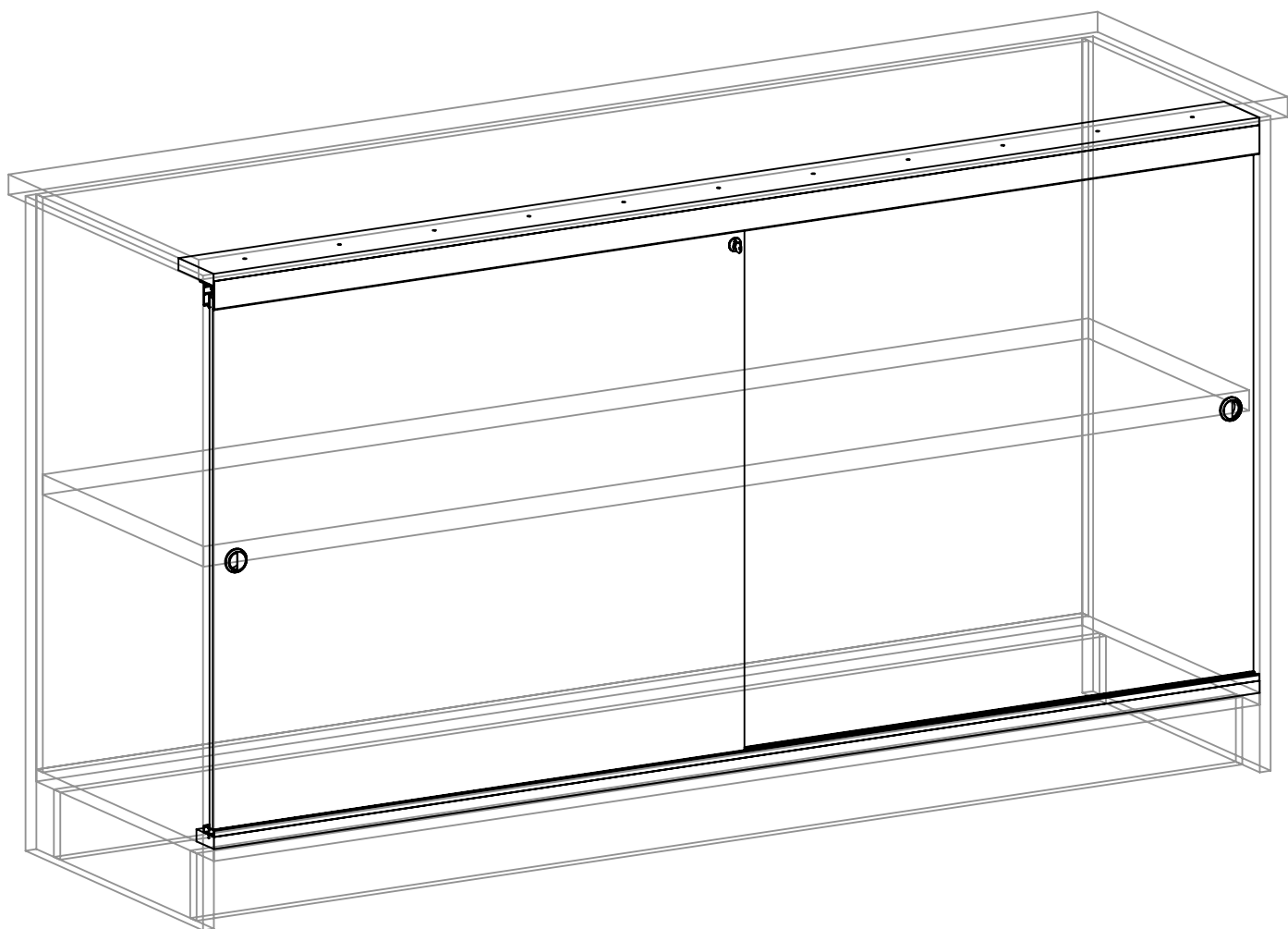

ASSEMBLY INSTRUCTIONS

www.shopforshops.com

Jan 2015

PARTS LIST

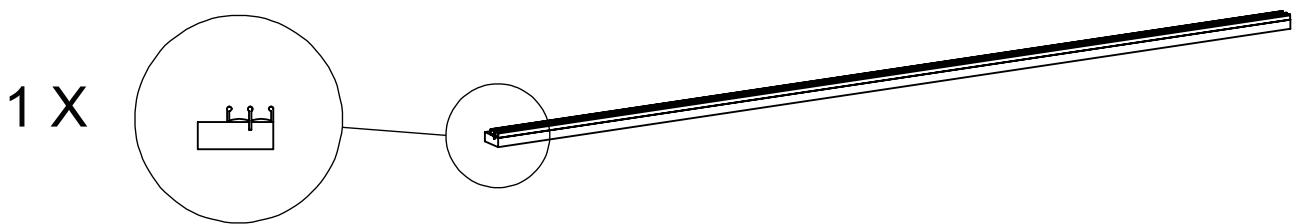
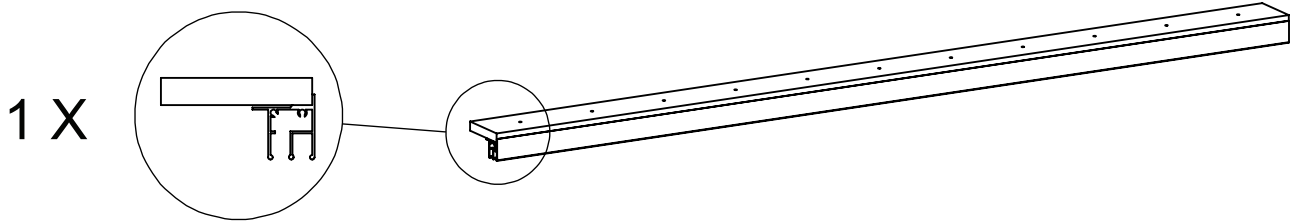

A

B

C

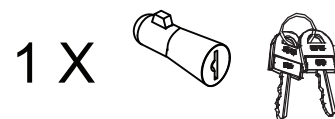
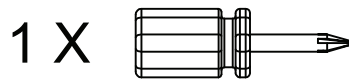
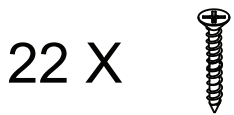

D

E

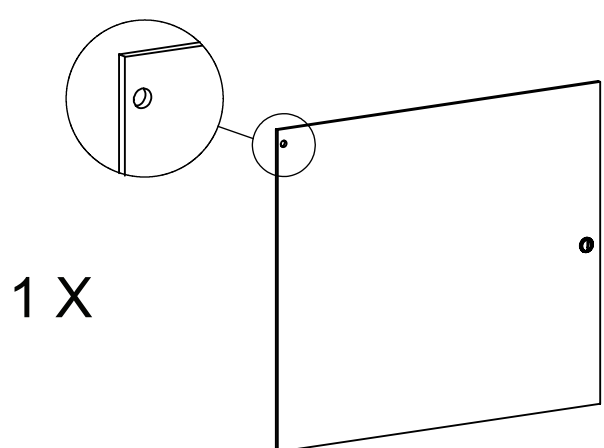
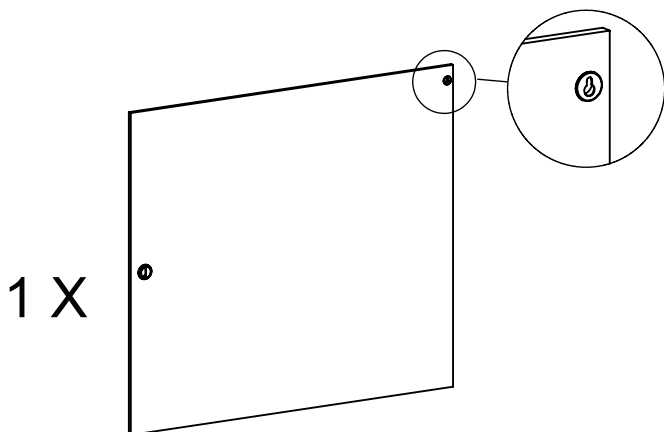



1

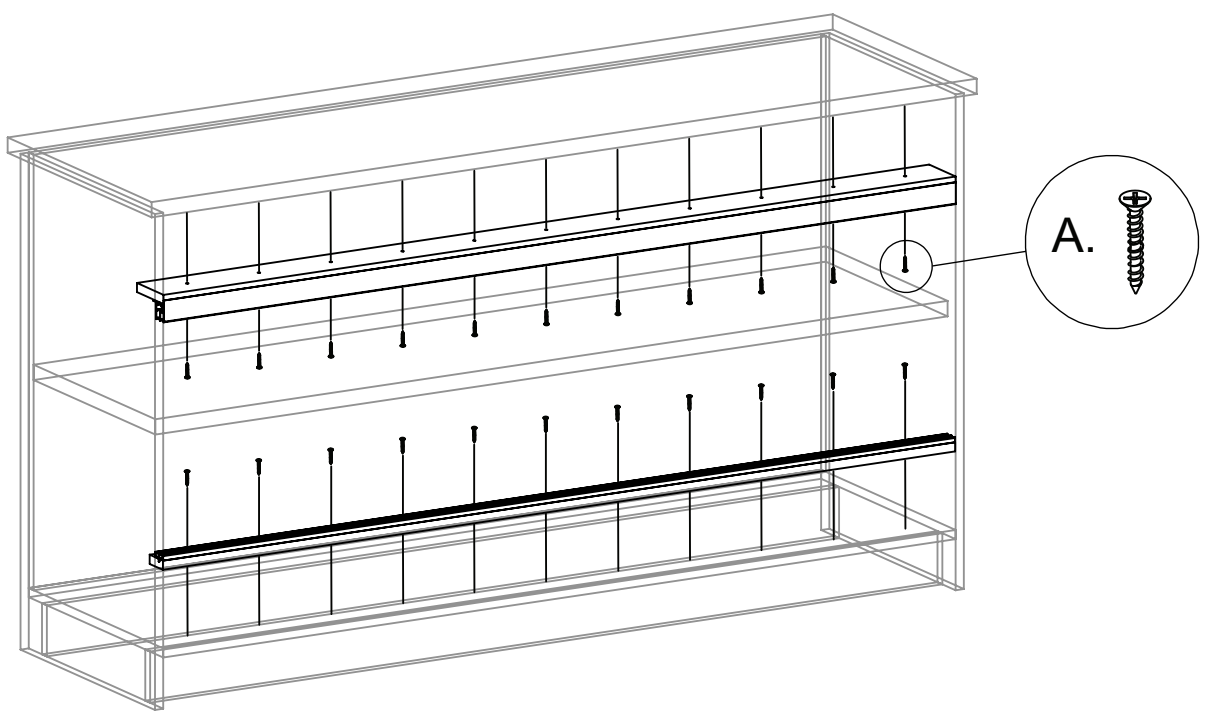
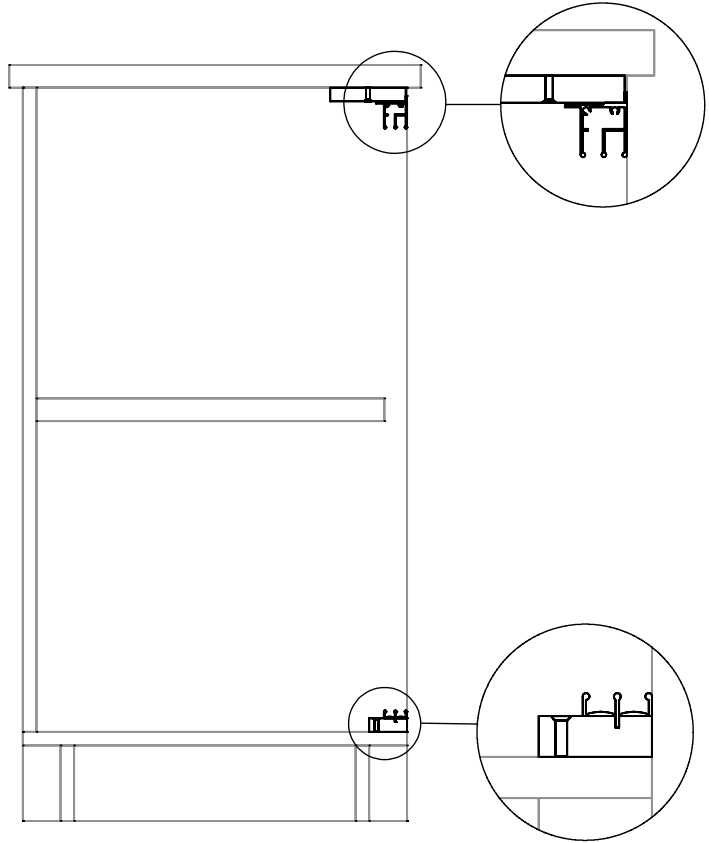

2

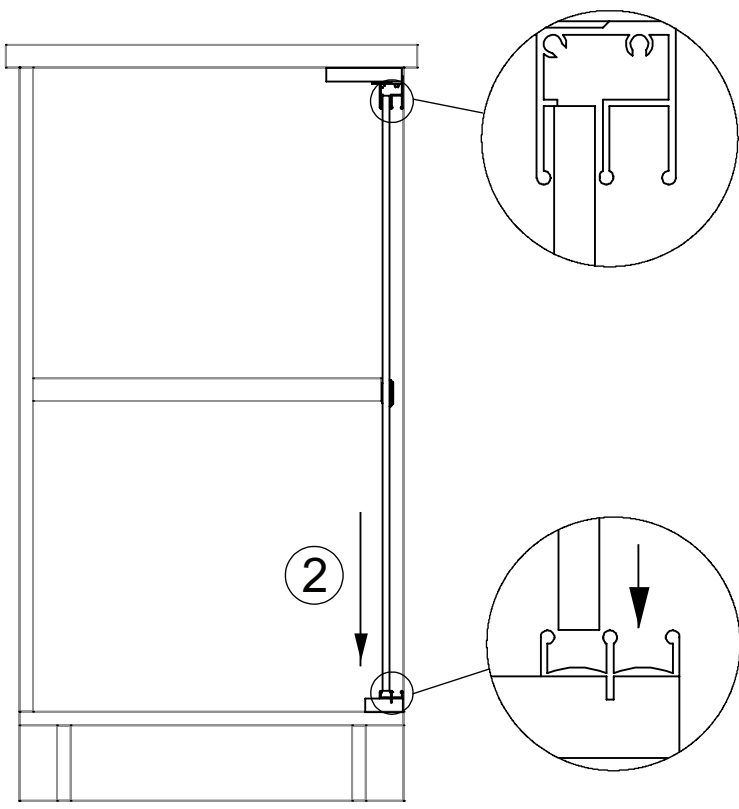
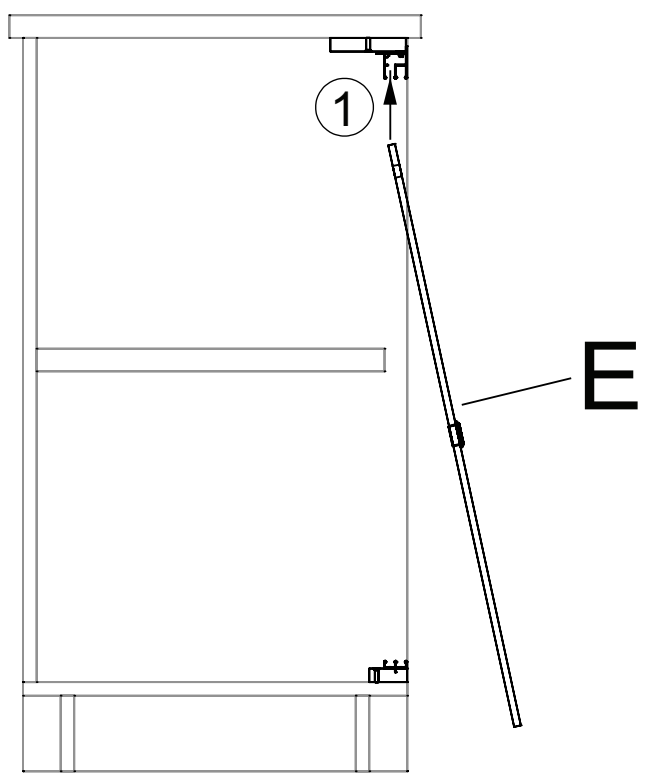

3

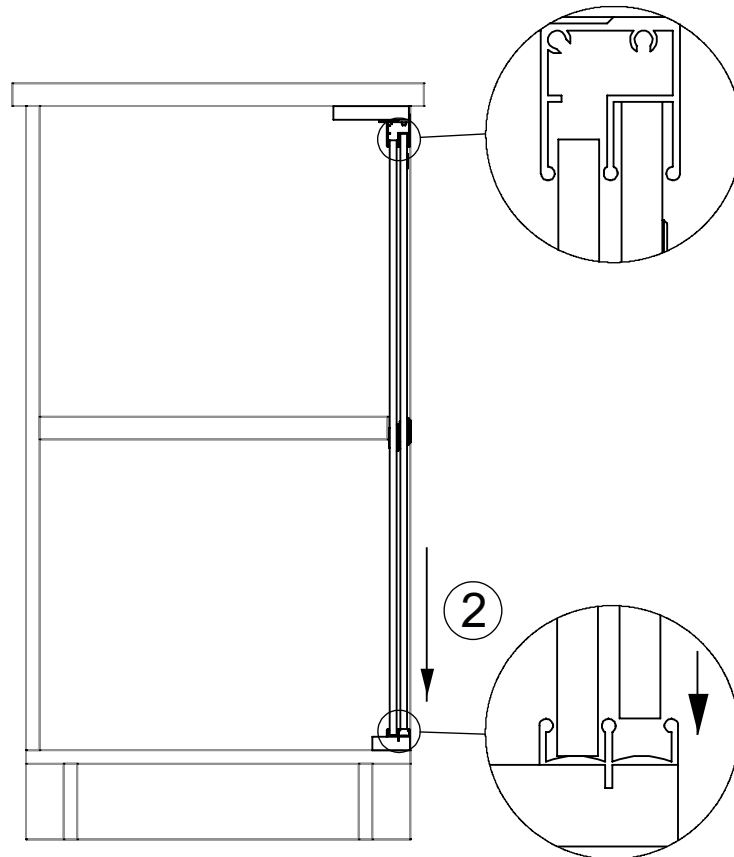
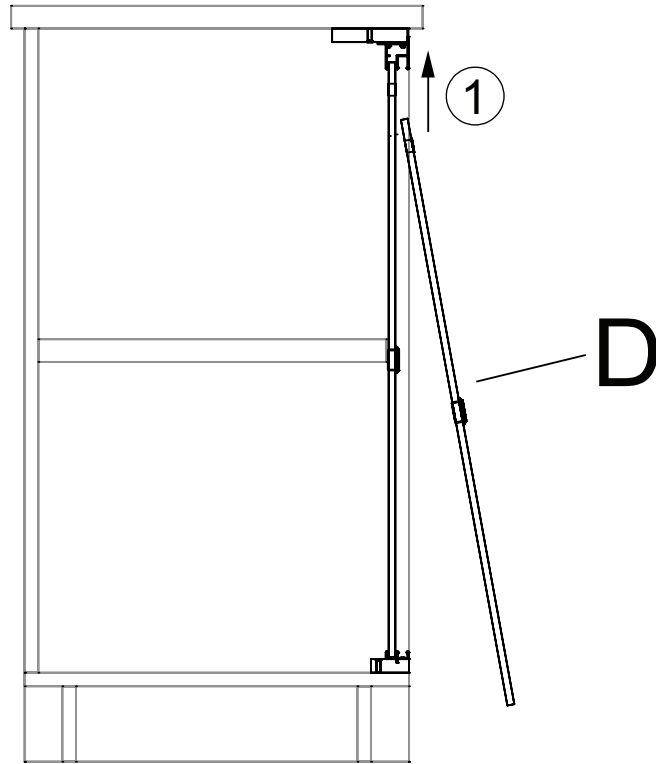

4

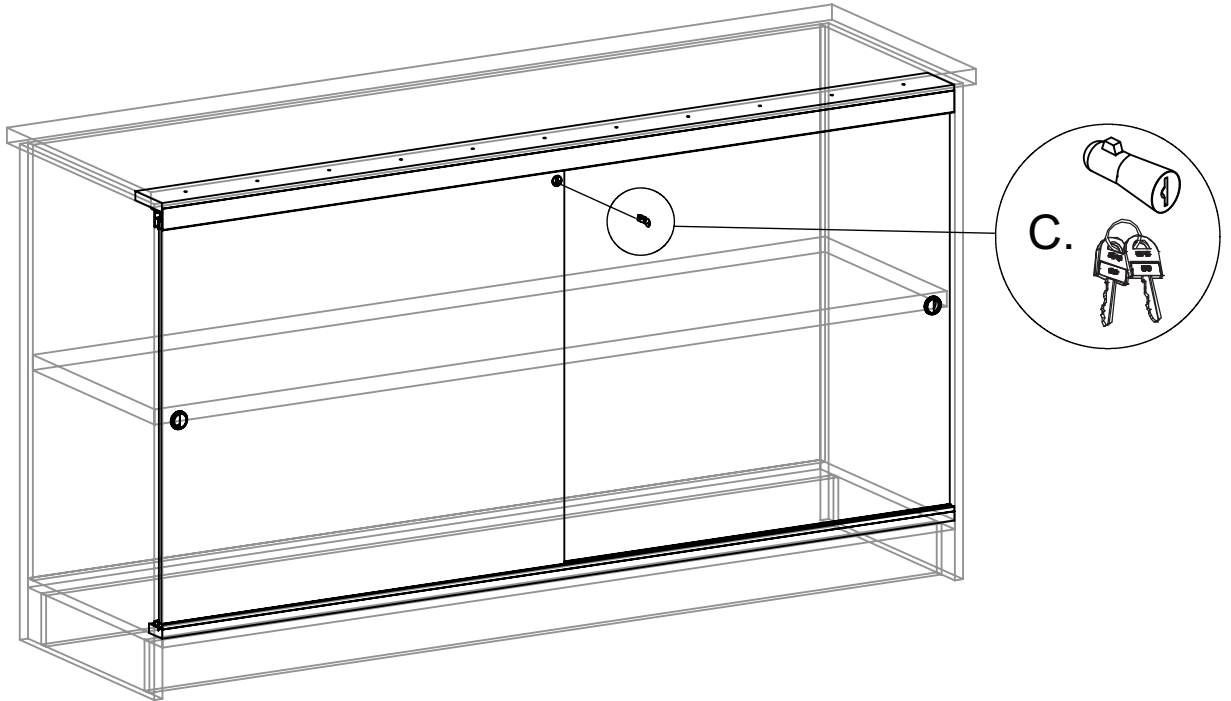

5

