

# MAXe CORNER BASE BRACKET SET FOR 30 MM SHELF - 400 MM D

E6904CH BKS WTS

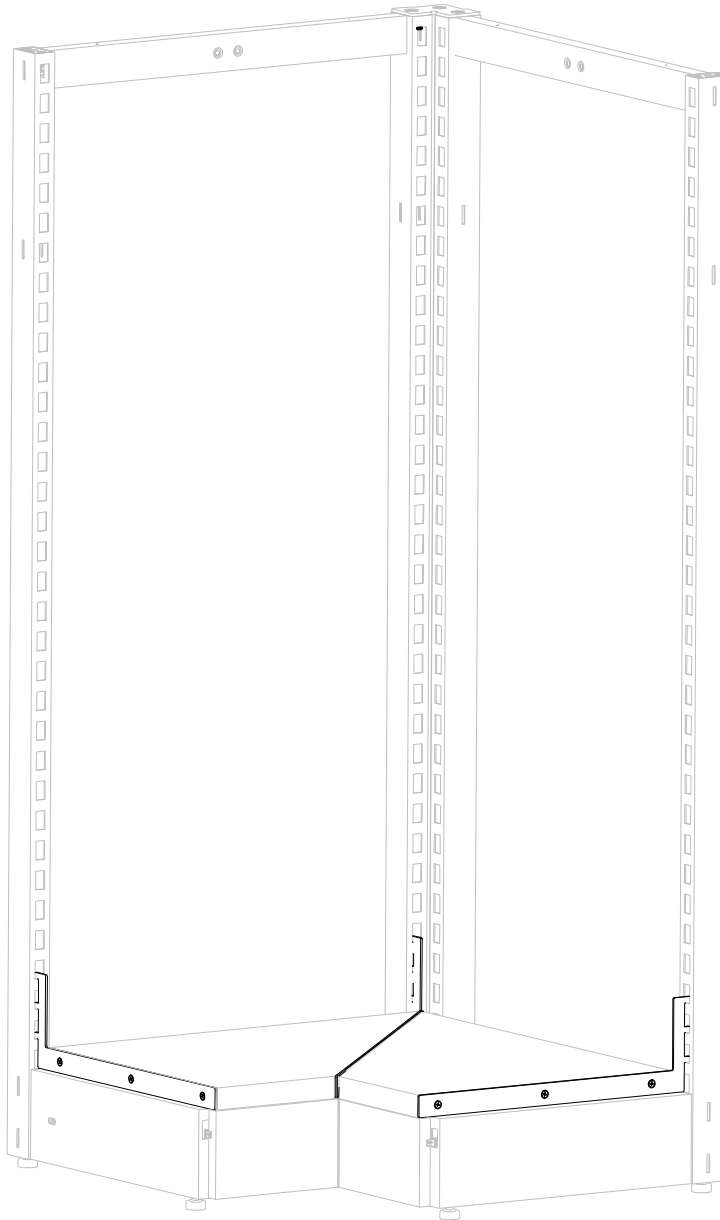

**ASSEMBLY INSTRUCTIONS**

[www.shopforshops.com](http://www.shopforshops.com)

JUL 2019

# PARTS LIST

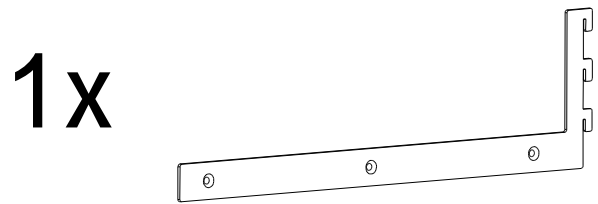
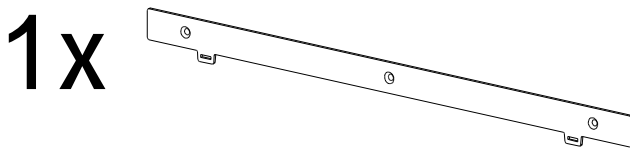
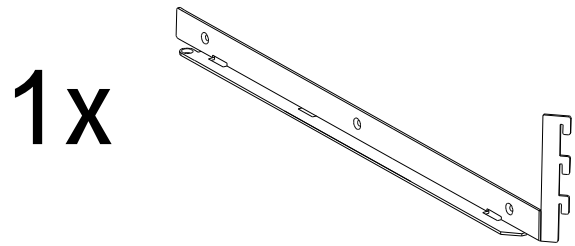
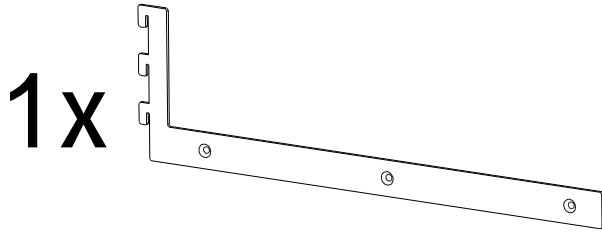

A

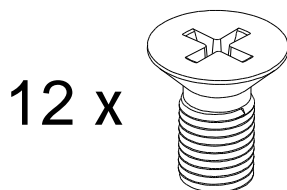

B

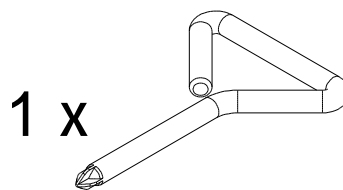

# 1

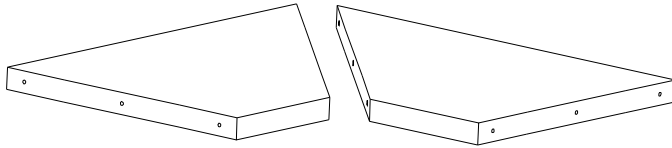

E6346

OR

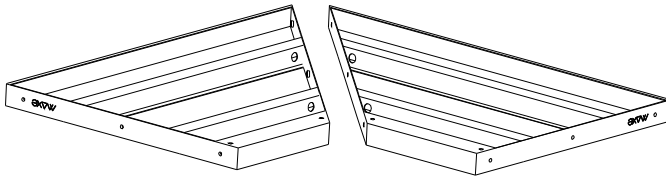

E7146

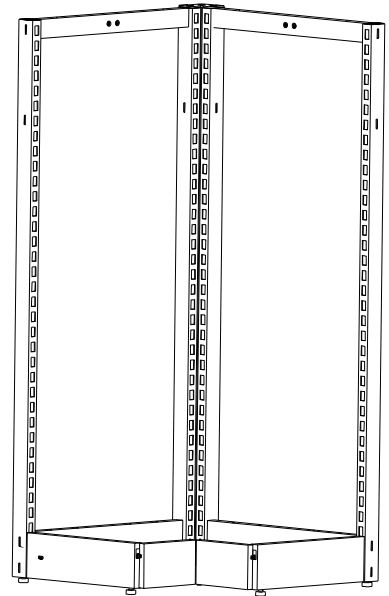

MAXe INSIDE CORNER SECTION WITH CORNER SKIRT SET

# 2

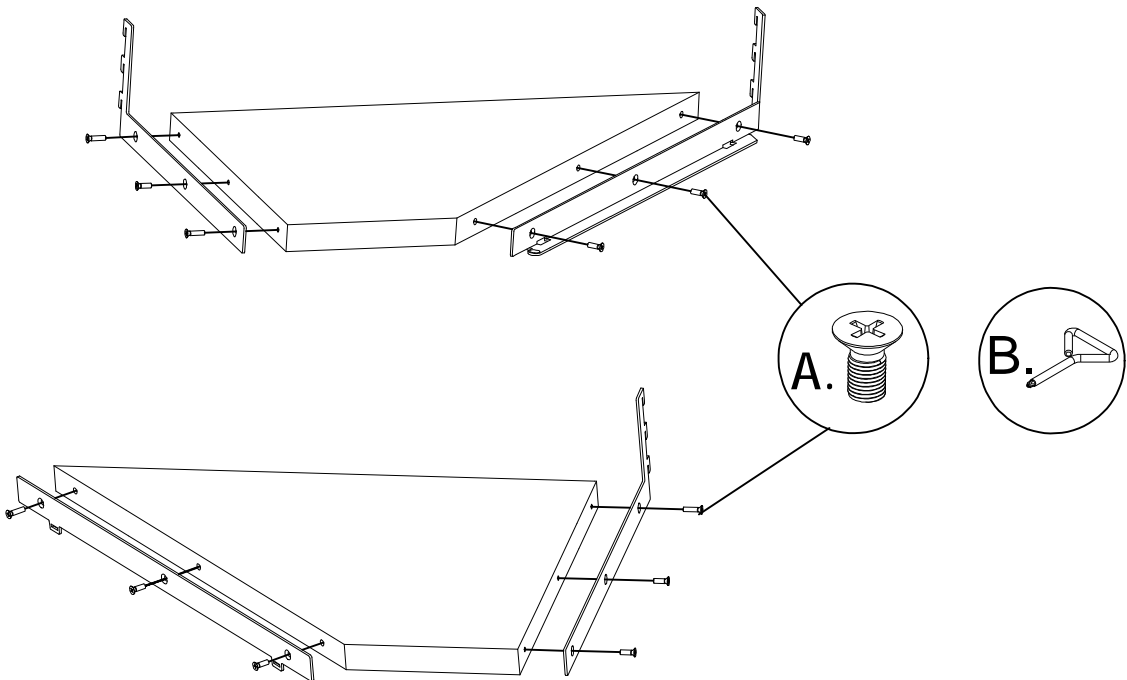

# 2

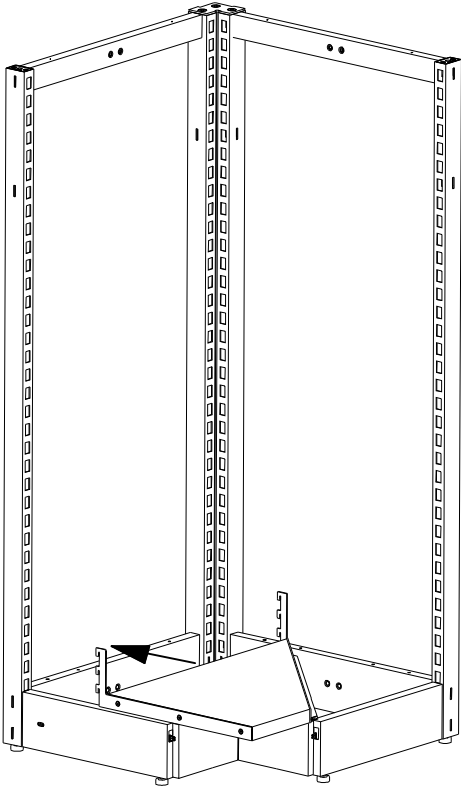

# 3

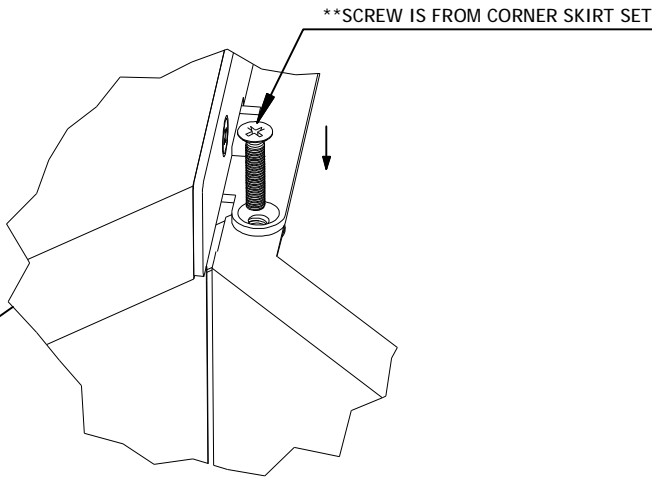
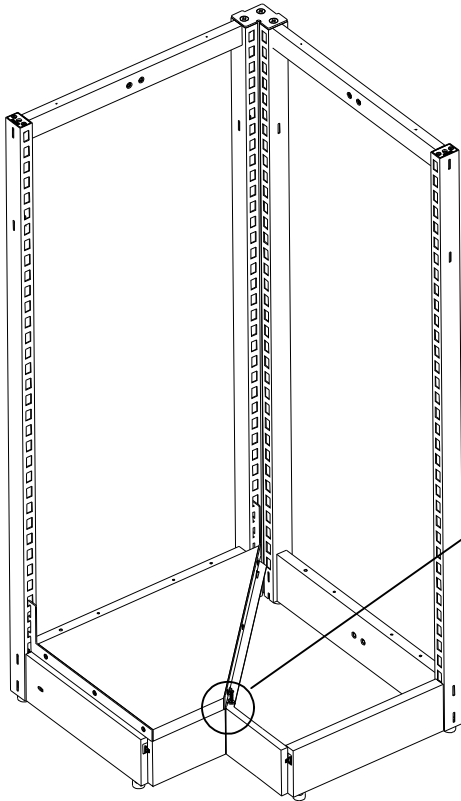

4

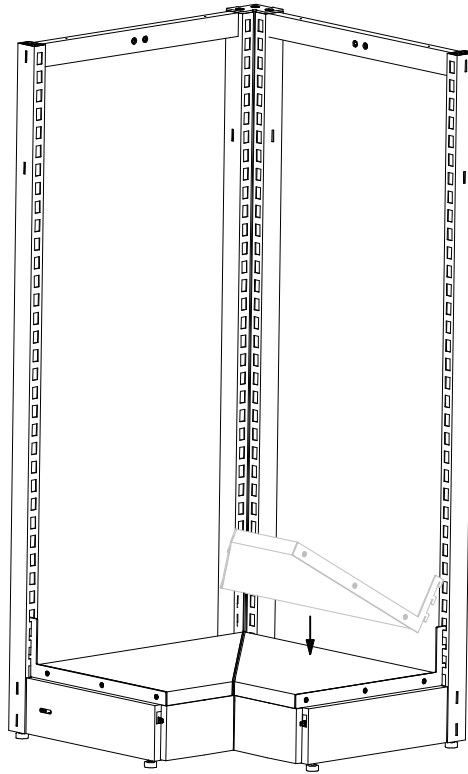

5

