

MAXe CORNER BASE BRACKET SET FOR 30 MM SHELF - 300 MM D

E6903CH BKS WTS

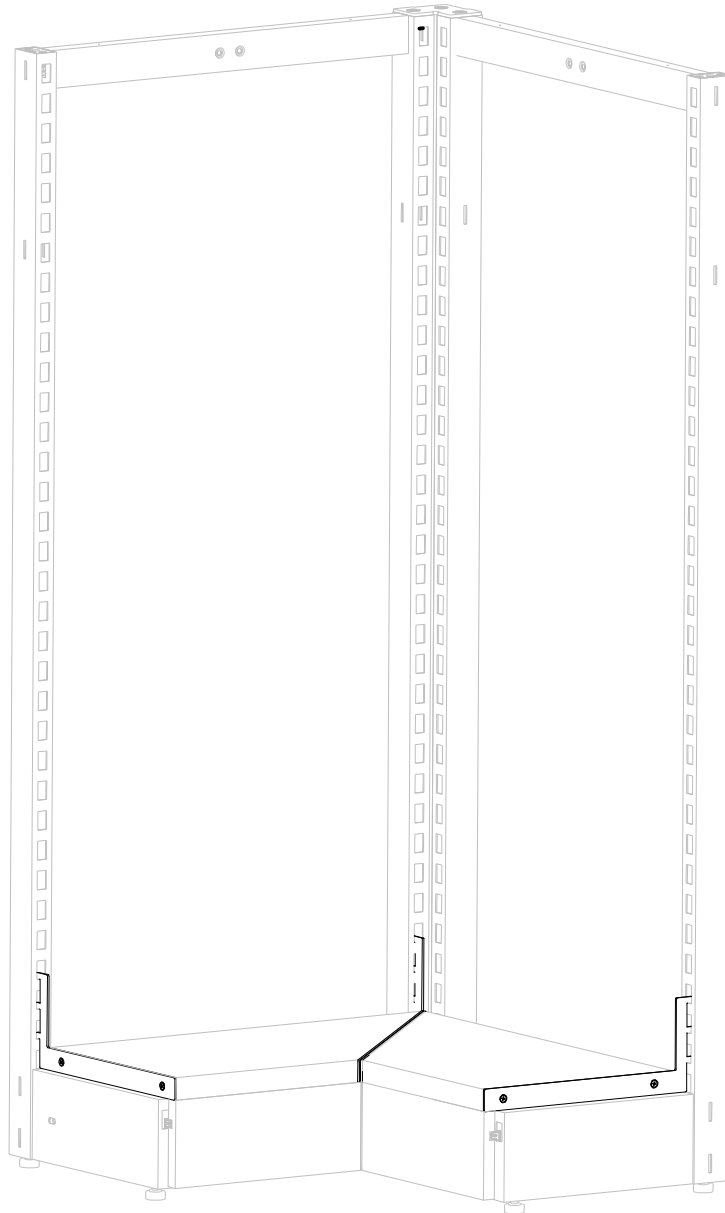

ASSEMBLY INSTRUCTIONS

www.shopforshops.com

JUL 2019

PARTS LIST

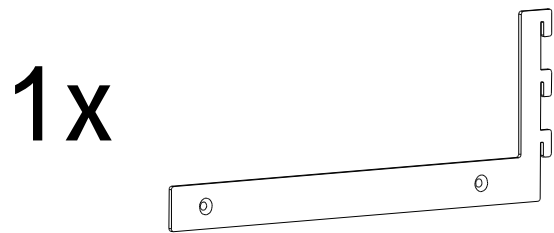
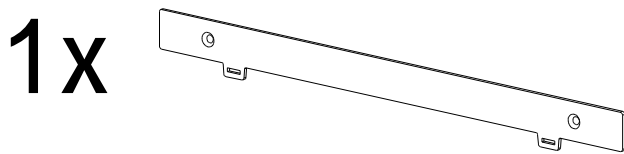
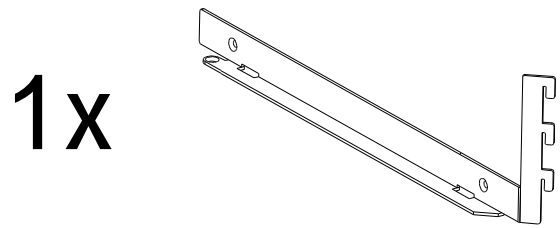
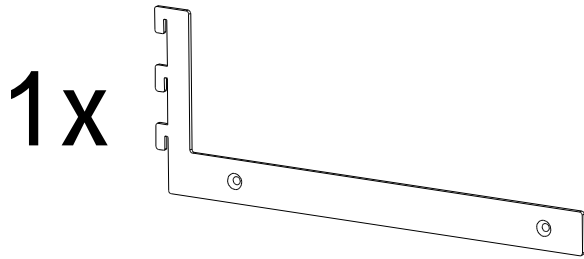

A

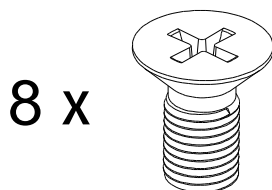

B

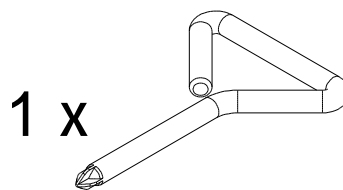

1

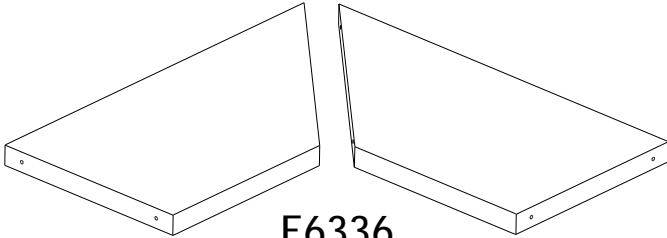

E6336

OR

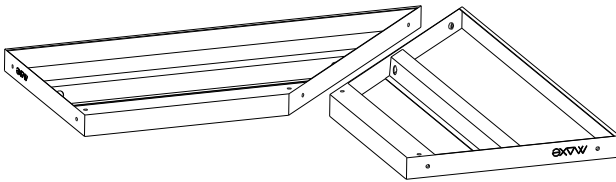

E7136

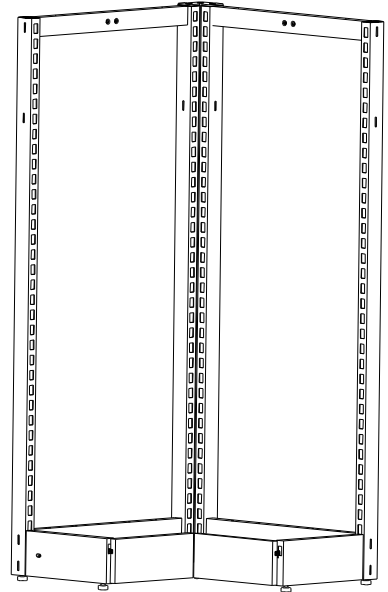

MAXe INSIDE CORNER SECTION WITH CORNER SKIRT SET

2

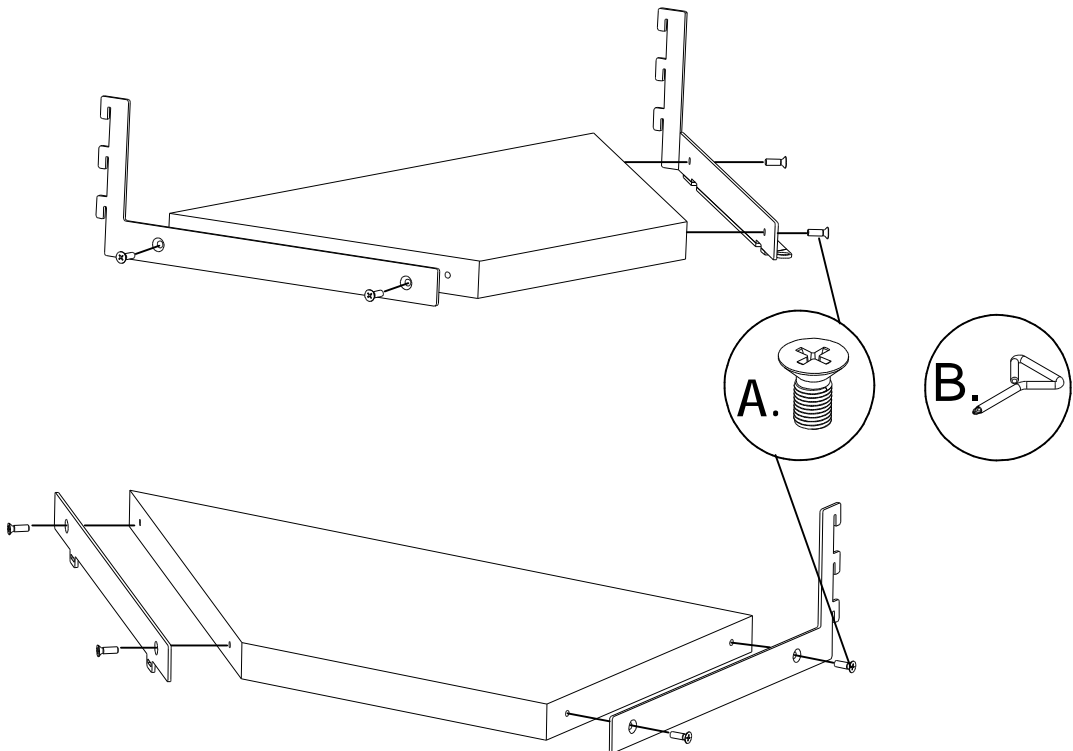

2

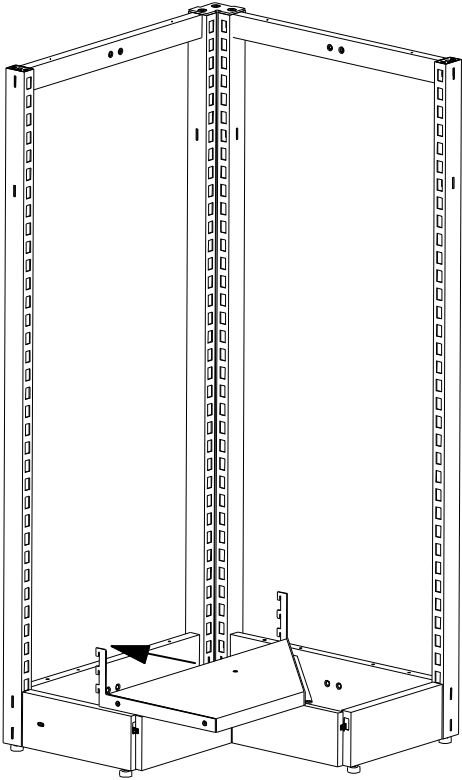

3

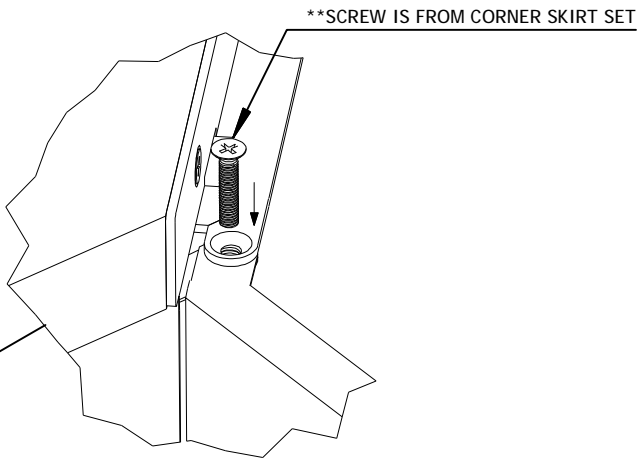
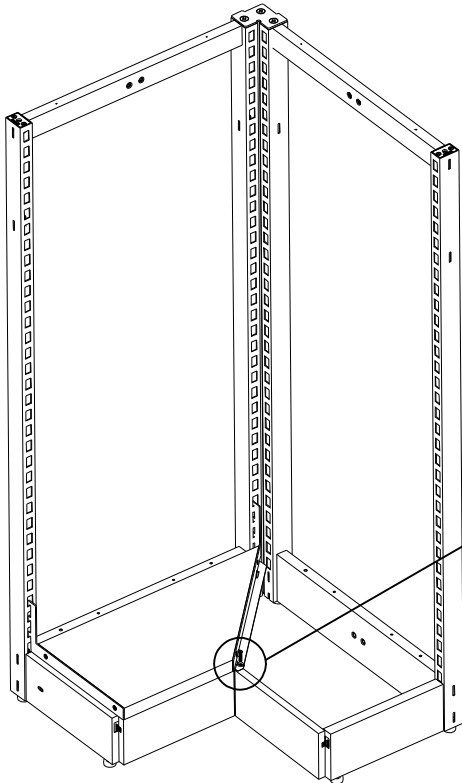

4

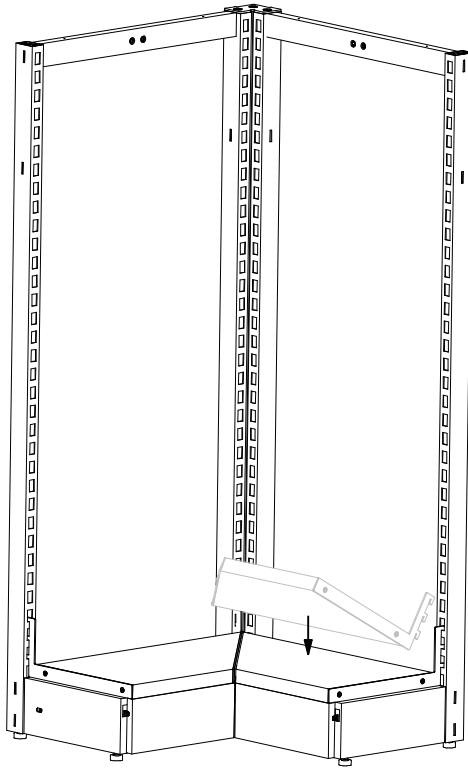

5

