

MAXe CORNER BRACKET SET FOR 30 MM SHELF - 400 MM D

E6804CH BKS WTS

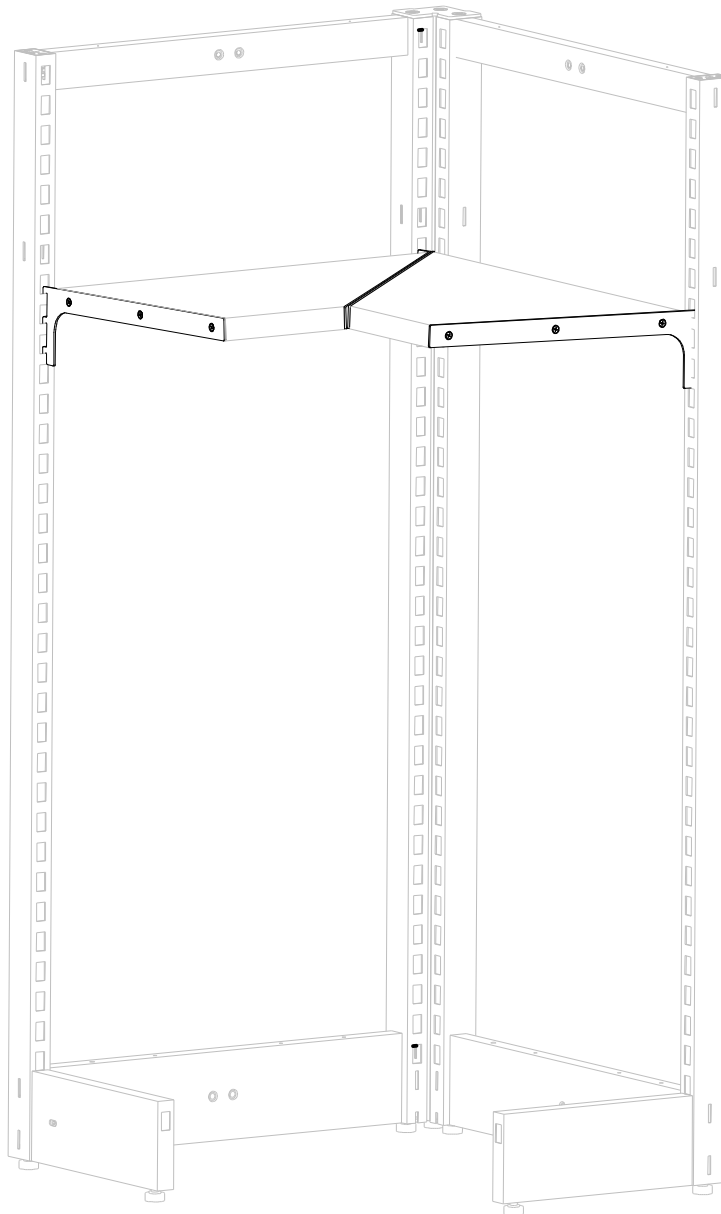

ASSEMBLY INSTRUCTIONS

www.shopforshops.com

JUL 2019

PARTS LIST

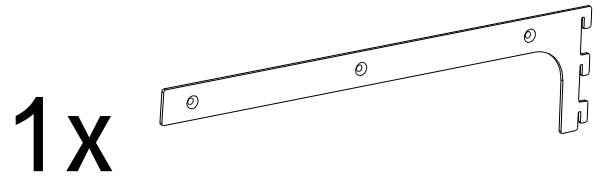
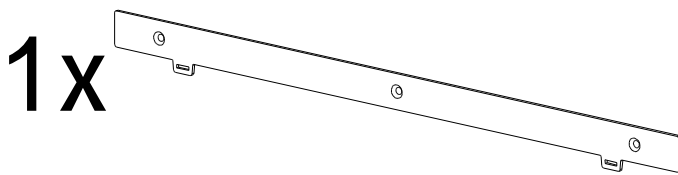
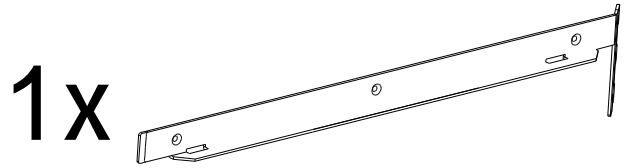
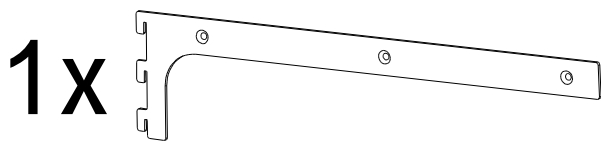

A

B

C

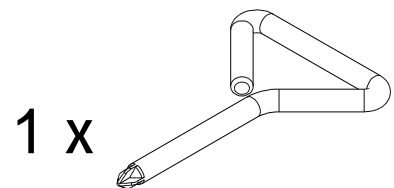
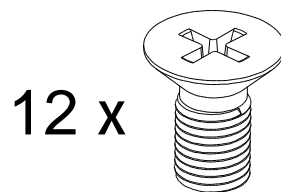
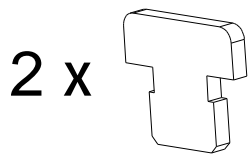

1

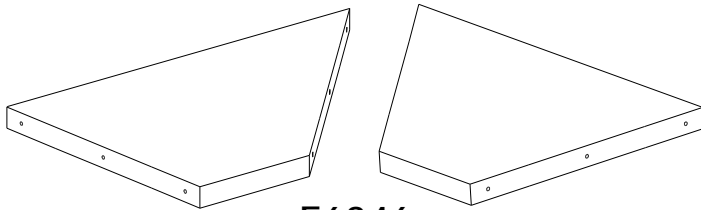

E6346

OR

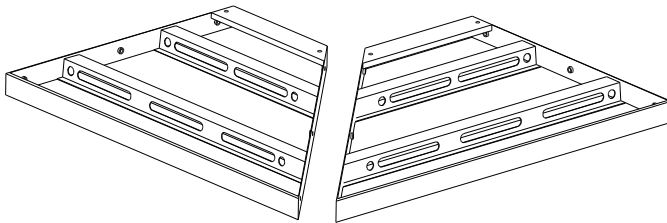

E7146

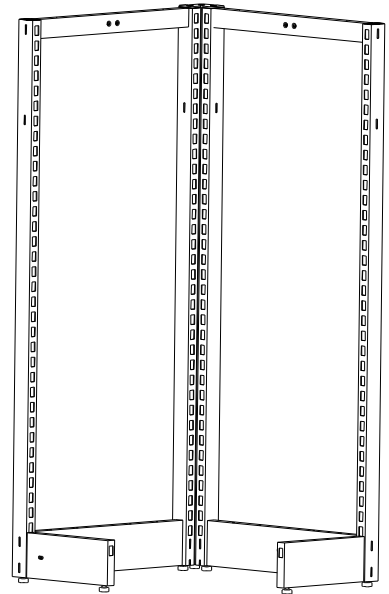

MAXe INSIDE CORNER SECTION

2

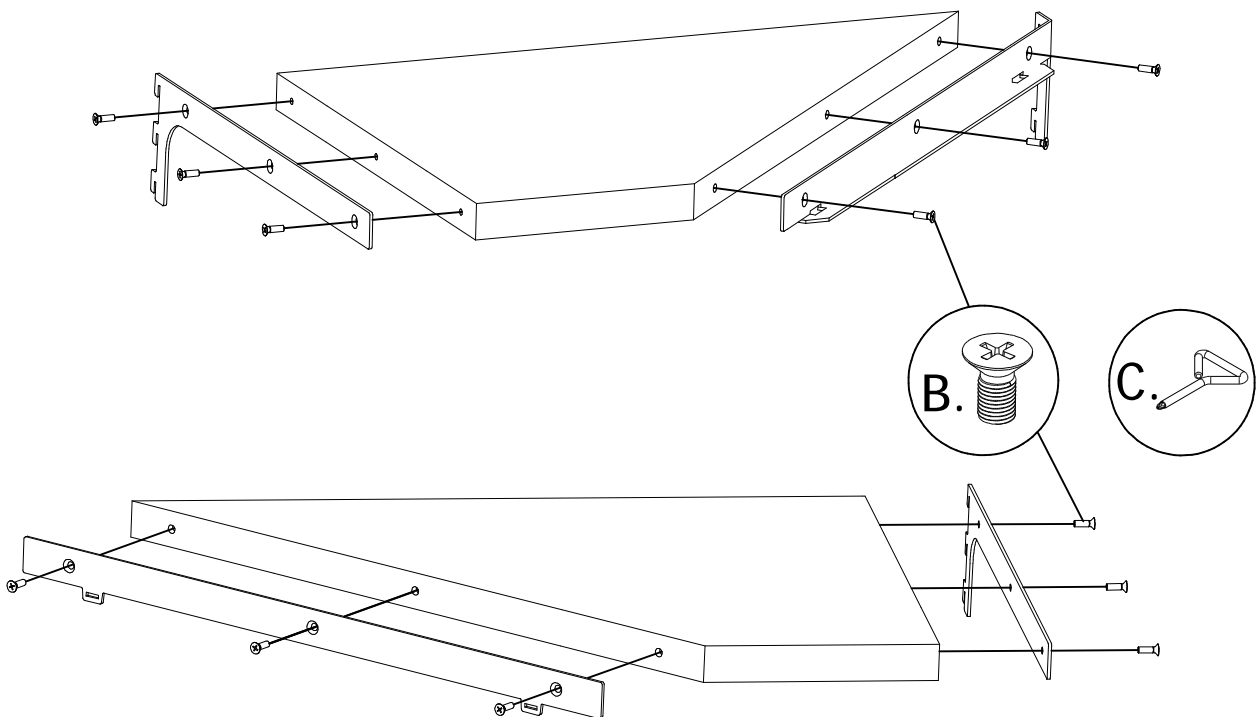

2

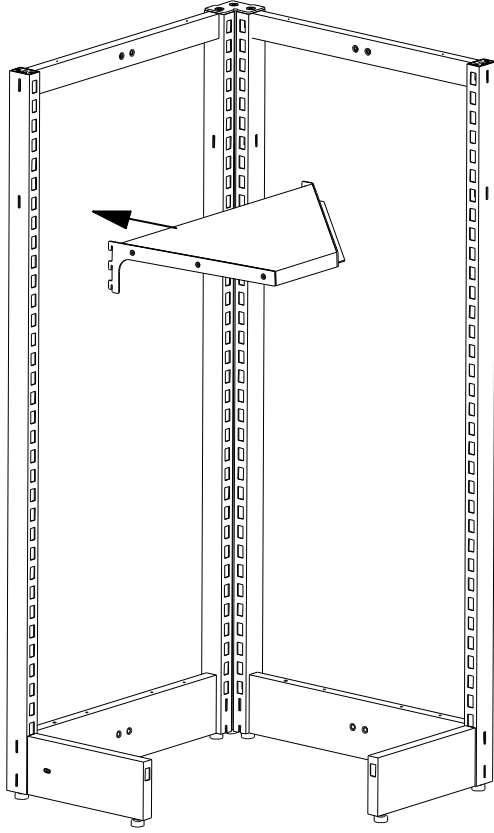

3

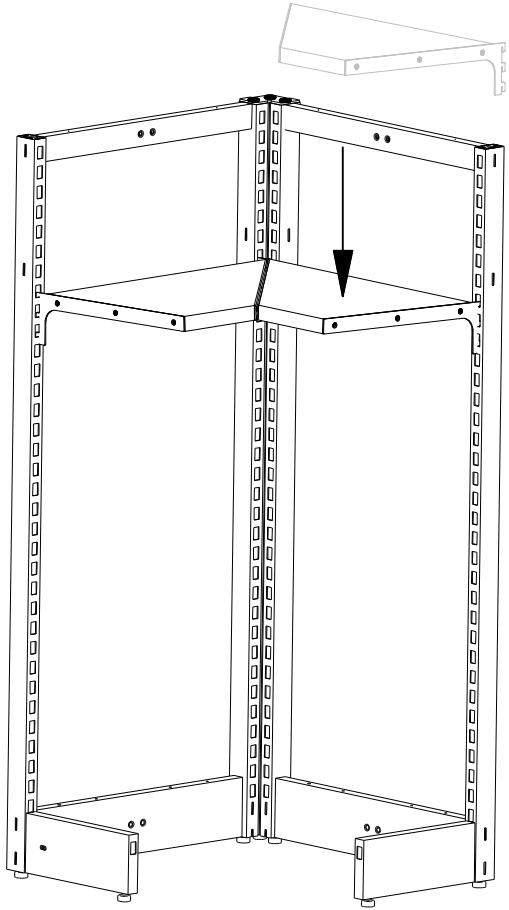

4

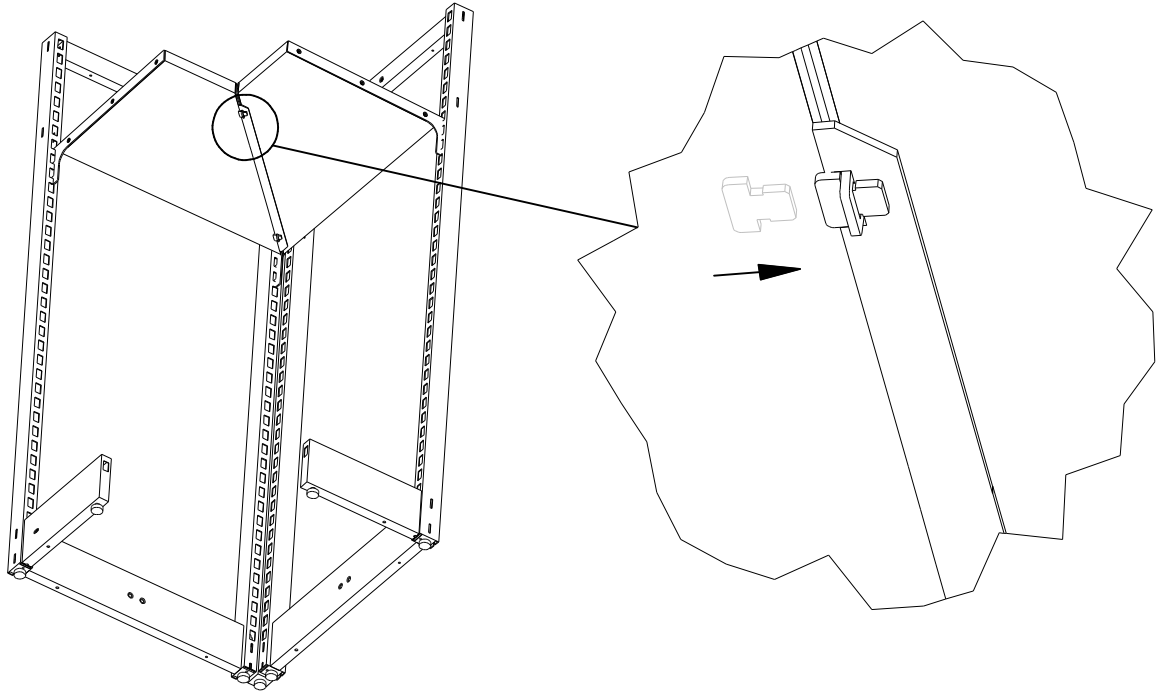

5

