

Panasonic®

LASER DISPLACEMENT SENSOR

HL-G1

User's Manual



Thank you for purchasing the HL-G1-series Compact Laser Displacement Sensor. Please read this operation manual carefully before you install and operate the product. Refer to the website of Panasonic Electric Works SUNX Co., Ltd.

Liability and Copyright for the Hardware

This manual and everything described in it are copyrighted. You may not copy this manual, in whole or part, without written consent of Panasonic Electric Works Europe AG (PEWEU).

PEWEU pursues a policy of continuous improvement of the design and performance of its products. Therefore we reserve the right to change the manual/product without notice. In no event will PEWEU be liable for direct, special, incidental, or consequential damage resulting from any defect in the product or its documentation, even if advised of the possibility of such damages.

Please direct support matters and technical questions to your local Panasonic representative.

LIMITED WARRANTY

If physical defects caused by distribution are found, PEWEU will replace/repair the product free of charge. Exceptions include:

- When physical defects are due to different usage/treatment of the product other than described in the manual.
- When physical defects are due to defective equipment other than the distributed product.
- When physical defects are due to modifications/repairs by someone other than PEWEU.

When physical defects are due to natural disasters.

Important Symbols

The following symbols are used in this manual:



Warning

The warning triangle indicates especially important safety instructions. If they are not adhered to, the results could be fatal or critical injury.



Caution

Indicates that you should proceed with caution. Failure to do so may result in injury or significant damage to instruments or their contents, e.g. data.



NOTE

Contains important additional information.



EXAMPLE

Contains an illustrative example of the previous text section.



Procedure

Indicates that a step-by-step procedure follows.



REFERENCE

Indicates where you can find additional information on the subject at hand.

Table of Contents

- 1. Introduction 1**
 - 1.1 Safety Instructions 2
 - 1.1.1 Safety Instructions for Laser Handling 3
 - 1.1.2 Safety Instructions for Installation, Maintenance, and Inspection 3
 - 1.1.3 Safety Instructions for the Power Supply 5
 - 1.1.4 Noise Countermeasures 6
 - 1.1.5 Safety Symbols and Identification 7
 - 1.2 CE Compliance 8
 - 1.3 Export to the US 9

- 2. Before Use 13**
 - 2.1 System Configuration 14
 - 2.2 List of Items and Accessories 15
 - 2.3 Parts Description 17
 - 2.4 Notes on Mounting 18
 - 2.4.1 Mounting the Cables 18
 - 2.4.2 Mounting Direction of the Sensor Head 19

- 3. Inputs and Outputs 23**
 - 3.1 Wiring Colors 24
 - 3.2 MI Input 26
 - 3.3 TM Input 27

3.4	I/O Circuit Diagrams	28
3.5	Analog Output Circuit	30
3.6	When the Status of the Output Data Is Undefined	31
3.7	Time Diagrams	33
4.	Functions	37
4.1	Classification of Functions.....	38
4.2	List of Functions and Default Settings.....	39
4.3	Control Panel and Digital Display	43
4.3.1	Basic Operation.....	44
4.3.1.1	Initialize	45
4.3.1.2	Save	46
4.3.2	Function Menu in Setting Mode	46
4.3.3	Shortcuts	49
4.4	Function Settings.....	50
4.4.1	Memory Selection.....	50
4.4.2	Sensing Functions.....	51
4.4.2.1	Sampling Cycle	51
4.4.2.2	Shutter Time.....	52
4.4.2.3	Light Intensity Monitor	53
4.4.3	Data Processing Functions	54
4.4.3.1	Average Function	54
4.4.3.2	Analysis Mode (Measuring Mode).....	56
4.4.3.3	Span	57
4.4.3.4	Offset.....	58
4.4.3.5	Zero-set OFF.....	59
4.4.4	Output Functions	60
4.4.4.1	Judgment Output Selection.....	60
4.4.4.2	Displacement Judgment.....	62
4.4.4.3	Judgment Output OFF Delay	63

4.4.4.4	Measurement Value Display on Panel.....	65
4.4.5	Analog Functions	65
4.4.5.1	Analog Output Selection	66
4.4.5.2	Analog Scaling	67
4.4.6	Alarm Functions	68
4.4.6.1	Analog Output at Alarm.....	68
4.4.6.2	Digital Output at Alarm.....	69
4.4.6.3	Alarm Delay.....	70
4.4.7	COM Functions (Multifunction Type Only)	71
4.4.7.1	Terminating Resistor Selection	71
4.4.7.2	Sensor No.	72
4.4.7.3	Baud Rate	73
4.4.7.4	Connection Mode.....	74
4.4.7.5	Sending Delay Time.....	76
4.4.8	System Functions.....	77
4.4.8.1	Timing Mode	77
4.4.8.2	Laser Control.....	78
4.4.8.3	Eco Mode	79
4.4.8.4	View Version	80
4.4.9	Buffering Functions (Multifunction Type Only).....	80
4.4.10	Functions Controlled by the MI Input	84
4.4.10.1	Zero Set	85
4.4.10.2	Reset.....	85

5. Serial Communication via RS422/485..... 87

5.1	Communication Specifications.....	88
5.1.1	Pin Arrangement	88
5.1.2	Connection Example	89
5.1.2.1	1:1 Communication via RS422	89
5.1.2.2	1:n Communication via RS485	90
5.2	Serial Commands	91
5.2.1	Read and Write Settings or Numerical Values.....	93
5.2.1.1	Read Command (Format 1 and 2)	93

5.2.1.2	Write Command (Format 1)	95
5.2.1.3	Write Command (Format 2)	95
5.2.2	Read Status of the Sensor Outputs (Format 3).....	96
5.2.3	Read Buffered Data from the Sensor Memory (Formats 4 – 6).....	98
5.2.3.1	Read Buffered Data from Start to End Point (Format 4).....	98
5.2.3.2	Read Differential Data (Format 5).....	99
5.2.3.3	Read Buffered Data in Binary Format (Format 6).....	100
5.2.4	Data Output from the Sensor (Format 7)	101
5.2.5	Error Response and Error Codes.....	102
5.2.6	BCC Creation	103
5.2.7	Command List	104
5.2.7.1	Basic Settings.....	104
5.2.7.2	Data Processing Settings.....	104
5.2.7.3	Output Settings.....	105
5.2.7.4	Analog Settings	105
5.2.7.5	Alarm Settings	106
5.2.7.6	System Settings	106
5.2.7.7	Read Commands	107
5.2.7.8	Buffering Commands.....	107
6.	Address List for MEWTOCOL Communication	109
6.1	Introduction.....	110
6.1.1	MEWTOCOL Command Formats	110
6.1.1.1	Read Command	110
6.1.1.2	Write Command	111
6.1.2	Sensing Settings	112
6.1.3	Data Processing Settings.....	112
6.1.4	Output Settings.....	112
6.1.5	Analog Settings	113
6.1.6	Alarm Settings	113
6.1.7	System Settings	113
6.1.8	Data Readout	114
6.1.9	Buffering Settings.....	114

6.2 Settings for Programmable Display (GT Series)..... 115

7. Troubleshooting 117

7.1 Problems and Remedies 118

7.2 Initialize..... 121

8. Specifications 123

8.1 Sensor Head Specifications..... 124

8.2 Beam Dimensions..... 127

8.2.1 Mutual Interference Area..... 127

8.2.2 Output Characteristics..... 130

8.3 Sensor Head Dimensions 131

8.3.1 Standard Type (HL-G1□□-A-C5)..... 131

8.3.2 Multifunction Type (HL-G1□□-S-J)..... 132

Index 133

Record of Changes

Chapter 1

Introduction

1.1 Safety Instructions

The laser is classified in accordance with JIS (JIS C 6802: 2005) and IEC (IEC 60825-1: 2007) standards.

Technical specification	
Laser wavelength	655nm
Maximum output	1mW
Laser class	2

Familiarize yourself with all safety instructions to ensure safe handling of the device. The safety instructions are broken down according to the cause and location of danger.



Warning

Using the product in a manner other than intended can lead to serious injury and/or significant material damage.

- This product is used to detect objects and does not incorporate control functions for the purpose of maintaining safety including the prevention of accidents.
- Do not use this product as a sensor to protect human bodies. Use products that conform to laws, regulations, and international standards such as OSHA, ANSI, and IEC standards, for applications protecting human bodies.
- Incorporate safety measures, such as a double safety mechanism, into the system if the use of the system is likely to result in serious injury or significant material damage.
- Do not use the system in combustion gas atmospheres. Otherwise, the system may result in explosion.
- This product has been developed/produced for industrial use only.
- Always observe the specifications including the ratings and ambient conditions (see page 123). Otherwise, the system may result in overheating or generate smoke.
- Do not disassemble or modify the system. Otherwise, an electric shock may be received or the system may generate smoke.
- Do not touch the wires when the system is energized. Otherwise, you may receive an electric shock.
- In order to ensure the performance of the system, allow a warm-up time of at least 30 minutes after the system is turned ON.

1.1.1 Safety Instructions for Laser Handling



Warning

Danger of eye damage or burning your skin with exposed laser beam!

- **Be careful not to stare at the laser beam directly or the reflected light of the mirror surface.**
- **Install the sensor so the laser beam will be located higher or lower than eye level in order not to watch the beam directly while the system is in operation.**
- **Contact the nearest office of Panasonic Electric Works SUNX Co., Ltd. if the system breaks down. The product is not provided with a function to stop laser beam radiation automatically when the sensor head is disassembled. Do not disassemble the sensor head, or otherwise you may be exposed to the laser beam.**
- **Do not use the system in methods other than that specified in this manual. You may be exposed to hazardous laser radiation if the system is controlled or adjusted in procedures not specified in this manual.**
- **Read the descriptions of the warning label carefully before use. The warning label (English) is affixed to the side of the sensor head. Warning labels in Japanese, Korean, and Chinese are enclosed. Use them as needed.**
- **You may be exposed to hazardous laser radiation if the system is controlled or adjusted in procedures not specified in this manual**

1.1.2 Safety Instructions for Installation, Maintenance, and Inspection



Warning

Observe the safety instructions for installation and maintenance of the product to prevent injuries or damage!

Installation

- **Do not install the device in the following environments:**
 - **Areas exposed to intense interference light such as direct sunlight. Make sure that the illumination level of the light receiving surface does not exceed 3,000lx under incandescent light.**
 - **Areas with high humidity where condensation is likely to occur**
 - **Areas exposed to corrosive or explosive gases**

- Areas exposed to vibration or shock at levels higher than those specified (see page 124)
- Areas exposed to contact with water
- Areas exposed to too much steam or dust
- The life of the semiconductor laser depends on the ambient temperature. Use the system within the range of the specifications (ambient temperature for sensor head: -10°C to 45°C for operation, -20°C to 60°C for storage. Ambient humidity: 35% to 85% RH).
- Take appropriate measures, such as the use of a cooling fan, to drop the ambient temperature of the sensor head as much as possible if the sensor head is used close to heat-radiating objects.
- The sensor head radiates heat as well. Therefore, be sure to install the sensor head in places with as good thermal conductivity as possible. Mount the sensor head to an aluminum or steel plate with a minimum surface area of 200cm² if the ambient temperature is 40°C or higher.
- In the case of installing two or more sensor heads in parallel, mount each sensor head to an aluminum or steel plate with a minimum surface area of 200cm² and make sure that the ambient temperature does not exceed 40°C.
- Always keep the emitter and receiver of the sensor head clean. Make sure that the emitter and receiver are free of substances that refract light, such as water, oil, or fingerprints, or surface water, or matters that block light, such as dust and dirt. Clean the emitter and receiver with a soft lint-free cloth or lens cleaning paper.
- Check that the receiver will not receive direct ambient light the same as the laser light in wavelength, such as sunlight. Mount an appropriate object, such as a light shield plate, to the sensor head if high accuracy is especially required.

Maintenance

- Turn OFF the system to stop laser emission before cleaning the system.
- Molded resin is used in some parts of the system. Do not use organic solvents such as paint thinner or benzene to wipe the dirt on the system.
- Do not wipe the glass portion of the laser aperture too strongly. Scratches on the glass may cause measurement errors.
- Always keep the emitter and receiver of the sensor head clean. Make sure that the emitter and receiver are free of substances that refract light, such as water, oil, fingerprints, surface water, or matters that block light, such as dust and dirt. Inspect the surfaces regularly and always keep them clean.
- Blow away large particles of dust, if any, using a camera lens blower.
- To remove small particles of dust or fingerprints, use a soft lens cleaning cloth or lens cleaning paper and lightly wipe them out.
- Use a cloth moistened with a small amount of alcohol to wipe out tough dirt carefully.

Inspection

- Inspect the system regularly to maintain the performance of the system and make it possible to use the system under optimum conditions.
- Check that no I/O terminal connections are loose or disconnected.
- Check that the glass surface on the laser aperture is free of dust, dirt, or fingerprints.
- Check that the power supply voltage is within the rated range (21.6 to 26.4V DC).
- Check that the operating ambient temperature is within the range of -10°C to 45°C for the sensor head.
- Check that the operating ambient relative humidity is within the range of 35% to 85%.

1.1.3 Safety Instructions for the Power Supply

- Be sure to supply a rated voltage of 21.6 to 26.4VDC.
- The internal circuit may be damaged if an external surge voltage (single-polarity, full-wave voltage) in excess of $500V \pm 1.2 \times 50\mu s$ is imposed. Insert a surge absorber between power input terminals if the external surge voltage is likely to exceed 500V.
- Select a power supply with a maximum ripple of 0.5V (peak to peak) and a minimum current capacity of 0.5A.
- Be sure to ground the frame ground terminal (FG) in order to prevent an adverse influence of high-frequency noise if a commercially available switching regulator is used for the power supply.
- A transformer may be connected to the power supply on the condition that the transformer is of isolation type. The product or the power supply may be damaged if an auto transformer is used.
- In order to protect the system from abnormally high voltages from the power supply line, be sure to use an isolated power supply with a built-in protective circuit.
- In the case of using a power supply that does not incorporate a protective circuit, be sure to connect the power supply to the system through a protective element, such as a fuse.

Power supply sequence for the sensor head

- Arrange a power supply sequence so that the sensor head will be turned ON earlier than the power supply.
- Arrange a power supply sequence so that the power supply will be turned OFF earlier than the sensor head.
- Do not turn ON the sensor head again within 10 seconds after the sensor head is turned OFF.

- The system will be ready to operate approximately 40 to 50 seconds after the system is turned ON, depending on the contents of settings. Note that the status of the outputs is undefined during startup.
- An analog voltage of 11V and an analog current of approximately 21.6mA will be output until the system becomes ready to operate.
- Do not turn OFF the system while system settings are being saved. In the worst case, the sensor head may be damaged and fail to restart.
- If an instantaneous power failure occurs, the system will operate continuously or go to the initial power-on state, depending on the duration of the power failure. Do not use the system in environments where instantaneous power failures occur.

1.1.4 Noise Countermeasures

- Install the system separated as much as possible from noise-generating sources, such as high-tension lines, high-voltage equipment, power lines, power equipment, machines generating high-voltage ON/OFF surges, welding machines, and inverter motors.
- Install the system separated as much as possible from radio equipment incorporating transmission circuitry, such as amateur radio transmitters.
- Do not touch the connector parts when the system is energized. Keep in mind that the internal circuit may be damaged if an excessive level of static electricity is imposed on the connector parts.
- Keep the sensor cable at least 100mm away from other wires and make sure that the sensor cable is not in parallel with them. Separate the sensor cable from high-voltage and power circuit lines. Shield the sensor cable with grounded conduits if it is unavoidable to lay the sensor cable together with high-voltage or power circuit lines.
- Keep the I/O signal lines at least 100mm away from power lines and power supply lines. All signal lines should be connected as short as possible.
- The analog output of the system is adversely influenced by heavy noise in the power supply. In that case, use a noise filter or noise-cut transformer.
- It is recommended to use shield cables for I/O signal wires and connect the shields to the FG.
- The analog output is easily affected by external noise. Use the shield cable and lay it as short as possible.
- Ground the FG independently at a resistance not exceeding 100Ω. The FG may be adversely affected if the ground is shared with other equipment.

1.1.5 Safety Symbols and Identification

Read the descriptions of the warning stickers carefully before use. The warning sticker (English) is affixed to the side of the sensor head. Warning stickers in Japanese, Korean, and Chinese are enclosed. Please also refer to the list of safety symbols used in this manual (see page ii).

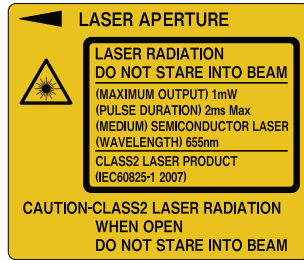
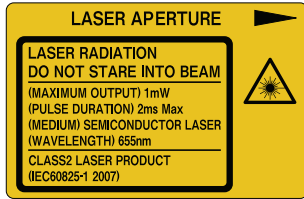

The positions of the stickers on the product are shown below.

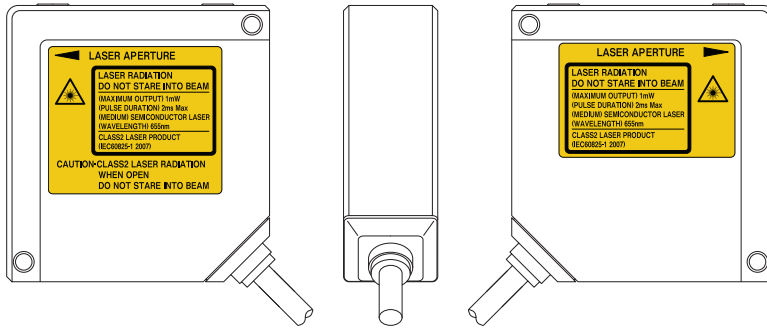

1.2 CE Compliance

To ensure compliance with CE regulations, install the product as follows:



◆ NOTE

- **Make sure that the signal and power lines connected to the product are shorter than 30m.**
- **Attach a suitable ferrite core to the head cable as shown below.**

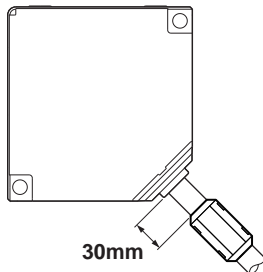

1.3 Export to the US

If the laser product is mounted on equipment and exported to the United States, it is subject to the regulation of the Food and Drug Administration (FDA). In order to prevent users from injury caused by laser products, the FDA specifies PART 1040 (Performance Standards for Light-Emitting Products). The FDA classifies laser products according to the degree of risk and provides safety measures for respective classes.

Requirements	Class ¹					
	I	IIa	II	IIIa	IIIb	IV
Performance (all laser products)						
Protective housing [1040.10(f)(1)]	R ²	R ²	R ²	R ²	R ²	R ²
Safety interlock [1040.10 (f) (2)]	R ^{3,4}	R ^{3,4}	R ^{3,4}	R ^{3,4}	R ^{3,4}	R ^{3,4}
Location of controls [1040.10(f)(7)]	N/A	R	R	R	R	R
Viewing optics [1040.10(f)(8)]	R	R	R	R	R	R
Scanning safeguard [1040.10(f)(9)]	R	R	R	R	R	R
Performance (laser system)						
Remote interlock connector [1040.10(f)(3)]	N/A	N/A	N/A	N/A	R	R
Key control [1040.10(f)(4)]	N/A	N/A	N/A	N/A	R	R
Emission indicator [1040.10(f)(5)]	N/A	N/A	R	R	R ¹⁰	R ¹⁰
Beam attenuator [1040.10(f)(6)]	N/A	N/A	R	R	R	R
Manual reset mechanism [1040.10(f)(10)]	N/A	N/A	N/A	N/A	N/A	R ¹³
Performance (specific-purpose products)						
Medical [1040.11(a)]	S	S	S	S ⁸	S ⁸	S ⁸
Surveying, leveling, alignment [1040.11(b)]	S	S	S	S	NP	NP
Demonstration [1040.11(c)]	S	S	S	S	S ¹¹	S ¹¹
Labeling (all laser products)						
Certification/identification [1010.2,3]	R	R	R	R	R	R
Protective housings [1040.10(g)(6),(7)]	D	R ⁵	R ⁵	R ⁵	R ⁵	R ⁵
Aperture [1040.10(g)(4)]	N/A	N/A	R	R	R	R
Class warning [1040.10(g)(1),(2),(3)]	N/A	R ⁶	R ⁷	R ⁹	R ¹²	R ¹²
Information (all laser products)						
User information [1040.10(h)(1)]	R	R	R	R	R	R
Product literature [1040.10(h)(2)(i)]	N/A	R	R	R	R	R
Service information [1040.10(h)(2)(ii)]	R	R	R	R	R	R

R:	Required
N/A:	Not applicable
S:	Same requirements as for other products of that class.
NP:	Not permitted
D:	Depends on level of inner radiation



◆ NOTE

- The assignment to a class is based on the maximum level of laser exposure during operation.**

2. Required wherever and whenever such human access to laser radiation levels that exceed the limits of Class I is not necessary for the product to perform its intended function.
3. Required at the protective housing which is designed to be removed or displaced during operation or maintenance, if removal or displacement of the protective housing could permit human access to laser or collateral radiation.
4. The requirements for interlock differ depending on the class of inner radiation.
5. The contents of stickers differ depending on the level and wavelength of laser radiation inside the protective housing.
6. Warning statement sticker
7. CAUTION logotype
8. The method to measure the level of laser radiation to human body is required.
9. CAUTION if $2.5\text{mW}/\text{cm}^2$ or less, DANGER if greater than $2.5\text{mW}/\text{cm}^2$.
10. Time difference is needed between instruction and emission.
11. Exception should be provided for demonstration of laser products or light shows using laser of Class IIIb or IV.
12. DANGER logotype
13. Required on and after August 20, 1986.

Certification and identification stickers

The following sticker is used when the product is exported to the United States:

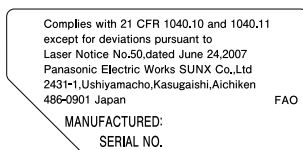

The position of the sticker on the product is shown below.

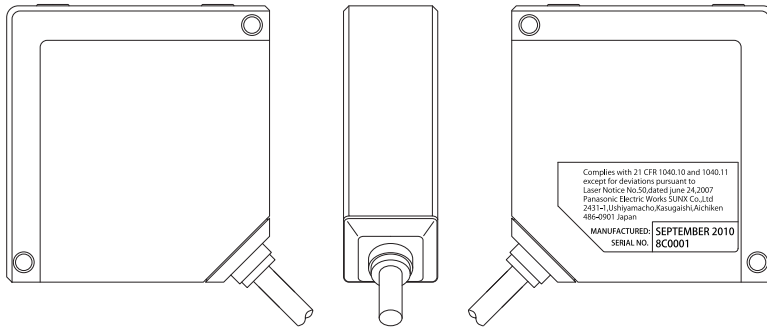

Sticker position on the product

Chapter 2

Before Use

2.1 System Configuration

This is how you connect the sensor head to other devices.

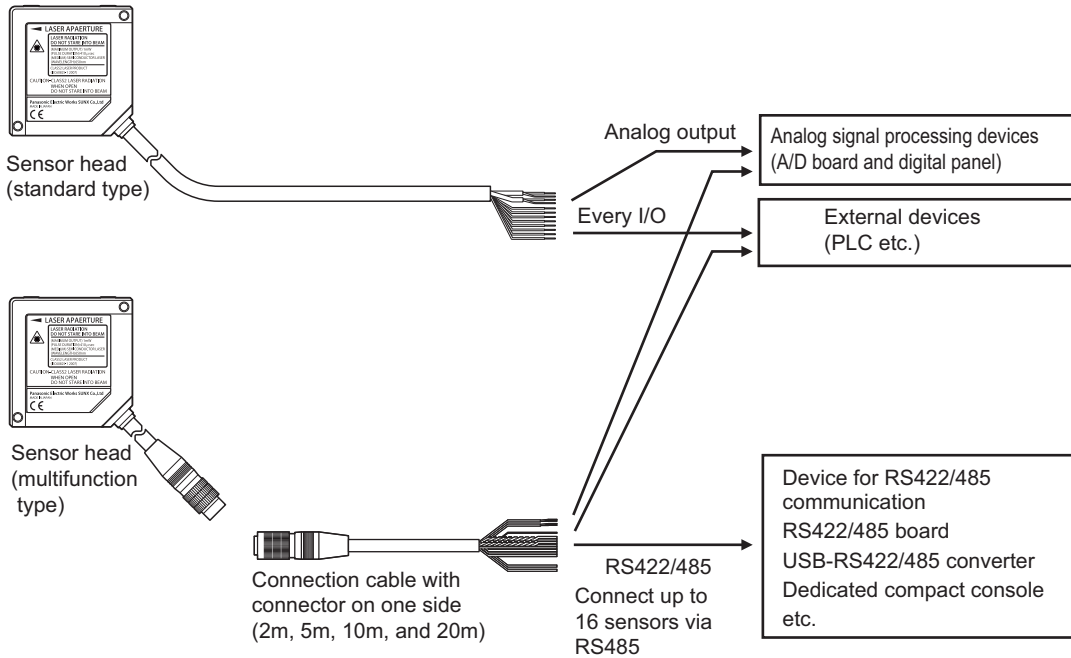

If you wish to configure the system with the software HL-G1SMI, you need to include the USB-RS422/485 converter in the configuration:

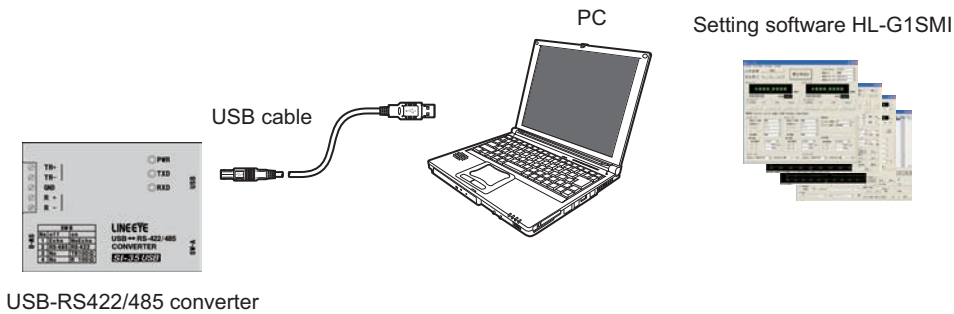

2.2 List of Items and Accessories

The following parts and accessories are available.

Sensor heads

Choose between the standard and the multifunction type.

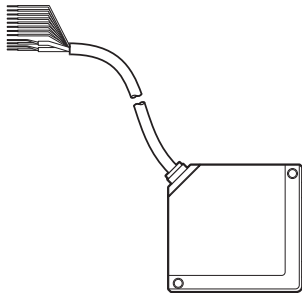

Standard type

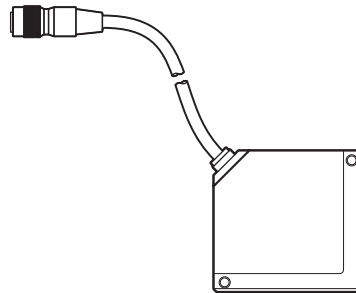

Multifunction type

Instruction manual

The sensor head instruction manual is in Japanese, English, German, Chinese, and Korean.

Warning labels

The warning label in English is attached to the sensor head. In addition, warning label in Japanese, English, Chinese, and Korean are supplied.

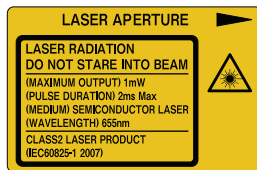
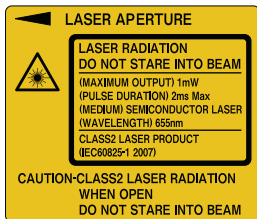



Extension cables

Item	Cable length	Order number
	2m	HL-G1CCJ2
	5m	HL-G1CCJ5
	10m	HL-G1CCJ10
	20m	HL-G1CCJ20

Touch terminal (optional, multifunction type only!)

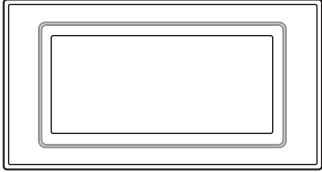
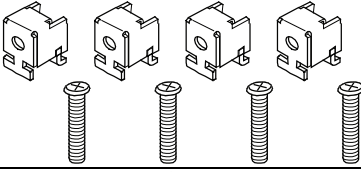
The touch terminal of the GT series of Panasonic Electric Works SUNX Co., Ltd. are available as a compact console for the HL-G1. Use a touch terminal to display HL-G1 settings and measurement values transmitted over the RS422 and RS485 connection.

Item	Description
	Touch terminal
	Mounting brackets and screws
	Terminal block for the touch terminal

The following GT series touch terminals can be used:

Connection type	Product name	Display properties	Backlight	Body color	Order number
Single connection	GT02G	<ul style="list-style-type: none"> • 3.8" 	Green/orange/red	Pure black	AIG02GQ14D
	GT02M	<ul style="list-style-type: none"> • STN • 240 x 96 dots 	White/pink/red	Silver	AIG02MQ15D
Multiple connection (1 to 4 units)	GT12G	<ul style="list-style-type: none"> • 4.6" 	Green/orange/red	Pure black	AIG12GQ14D
		<ul style="list-style-type: none"> • STN 		Hairline silver	AIG12GQ15D
	GT12M	<ul style="list-style-type: none"> • 320 x 120 dots 	White/pink/red	Pure black	AIG12MQ14D
				Hairline silver	AIG12MQ15D



◆ NOTE

- You can download screen data and the User's Manual for the GT terminal from the website of Panasonic Electric Works SUNX Co., Ltd. (<http://panasonic-electric-works.net>).

Setting and monitoring software HL-G1SMI (optional, multifunction type only!)

Download the software free or charge from <http://panasonic-electric-works.net>.

2.3 Parts Description

	<p>① Laser indicator (LASER) Lights up in green during laser emission.</p>
	<p>② Alarm indicator (ALARM) Lights up in orange if an alarm occurs during measurement.</p>
	<p>③ OUT1 indicator (OUT1) Lights up in yellow during OUT1 output.</p>
	<p>④ OUT2 indicator (OUT2) Lights up in yellow during OUT2 output.</p>
	<p>⑤ OUT3 indicator (OUT3) Lights up in yellow during OUT3 output.</p>
	<p>⑥ [ENTER] key Used to access the functions and to confirm input.</p>
	<p>⑦ Digital display Displays measurement values and system errors.</p>
	<p>⑧ [UP] key Used to select items or change numerical values.</p>
	<p>⑨ [DOWN] key Used to select items or change numerical values.</p>
	<p>⑩ Emitter Emits the laser light.</p>
	<p>⑪ Receiver Receives reflected light from measurement targets.</p>
	<p>⑫ Warning label Shows the laser emission position. Read the description carefully before using the sensor.</p>

2.4 Notes on Mounting

When mounting the sensor, make sure to use the correct method.



◆ NOTE

- Before installing the sensor, read the safety instructions about the installation environment, noise countermeasures, and the power supply.
- Fix the sensor head securely with M4 screws inserted into the two screw holes of the sensor head.

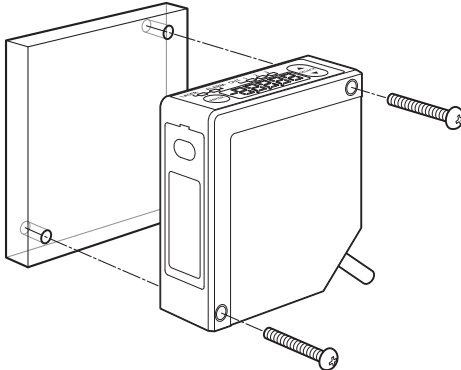

- The tightening torque should be $0.8\text{N}\cdot\text{m}$ or less.

2.4.1 Mounting the Cables



◆ NOTE

- Never use force around the connectors of the sensor head cable and connection cable. Do not bend the cables near the connectors. Doing so may result in cable disconnection.

- Do not pull the cable with a force of more than 29.4N when you connect the cable to the mounted sensor head.
- In the case of moving and using the sensor head, pay attention not to bend the cables in excess. The cable may be bent with a radius of 30mm or more. However, do not bend the cable within 20mm of the sensor head. For applications where cables need to be bent, use the multifunction sensor type because it uses replaceable connection cables.

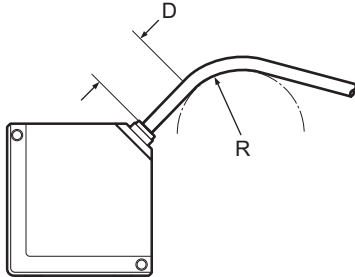

2.4.2 Mounting Direction of the Sensor Head

Mount the sensor head in the direction shown below to ensure precise and stable measurement.

Measurement of moving targets

When measuring a moving target that has extremely different adjacent colors or materials, mount the sensor head as shown below in order to minimize measurement errors.

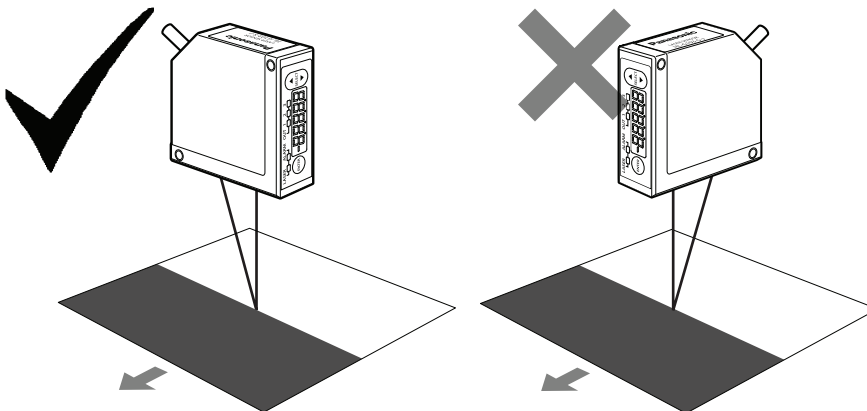

Measurement of rotating targets

When measuring a rotating target, mount the sensor head as shown below to minimize the adverse influence of vertical oscillation or displacement.

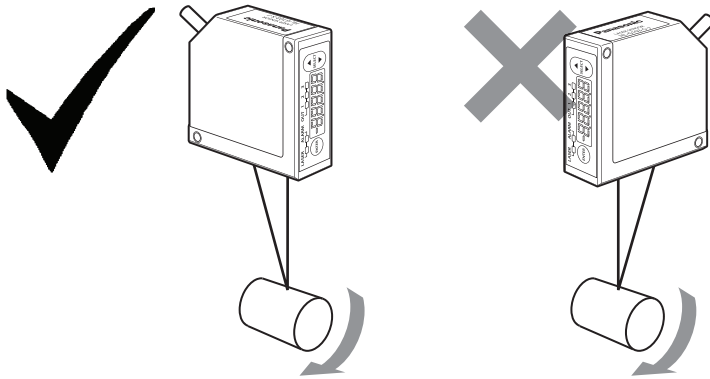

Measurement of targets with level differences

When measuring a moving target that has level differences, mount the sensor head as shown below to minimize interferences caused by the edges of the target.

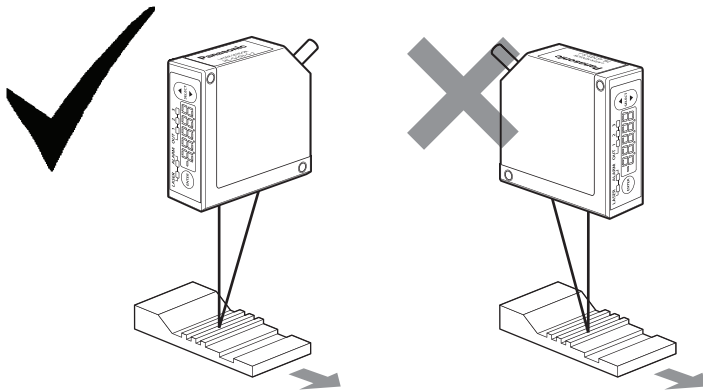

Measurement of targets in narrow spaces or slots

When measuring a target in a narrow space or slot, mount the sensor head as shown below so that the light beam between the emitter and the receiver is not blocked.

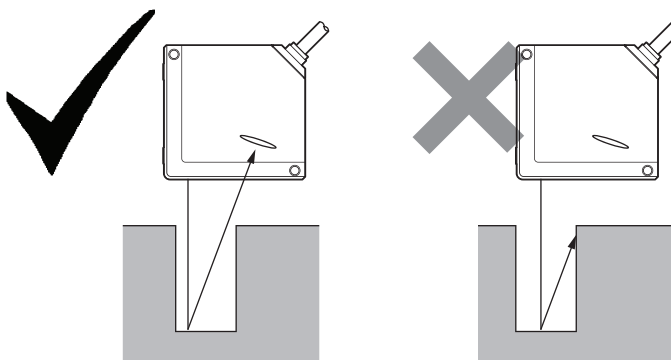

Mounting the sensor head to a wall

Mount the sensor head to the wall as shown below to ensure that the receiver does not receive light reflected from the wall at different angles. If there is a lot of reflection from the wall, paint the wall surface matte black.

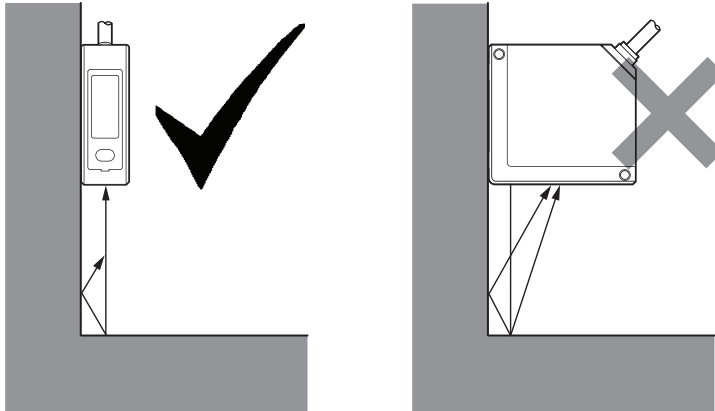
**Sensor head angle to the center of measurement targets**

Mount the sensor head so that the emitter and receiver will be located parallel to each other as shown below.

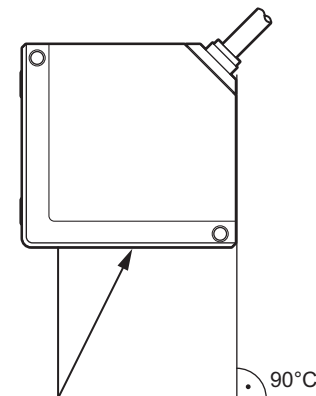
**◆ NOTE**

Refer to the sensor head specifications for the measurement center distance and measuring range (see page 127).

Chapter 3

Inputs and Outputs

3.1 Wiring Colors



◆ NOTE

The sensor heads produced before December 2010 use different wire colors. Please check the wire colors on the sensor head you are using.

Analog output lines

Pin No.	Signal name	Function	Lead wire color	
7	A(V)	Analog voltage output	Shielded single conductor	Black
8	AGND	Analog ground		
9	A(I)	Analog current output	Shielded single conductor	Gray
10	AGND	Analog ground		

I/O terminal block

Pin No.	Signal name	Function	Lead wire color	
1	OUT1	Judgment output 1	Black	
2	OUT2	Judgment output 2	White	
3	OUT3	Judgment output 3 or alarm output	Gray	
4	TM	Timing input	Pink	
5	MI	Multifunction input: Zero set, zero set OFF, reset, change memory, teach, save, and laser control Note: The function of the MI signal is determined by the duration of the signal (see page 26).	Violet	
6	NP	NPN/PNP type switching input (default = NPN)	Pink/Violet	
11	+SD	Transmission data	Twisted-pair wire	Green (before Dec 2010: Black)
12	-SD	Transmission data		Sky blue (before Dec 2010: White)
13	+RD	Reception data	Twisted-pair wire	Orange (wire color has not changed)
14	-RD	Reception data		Yellow (before Dec 2010: White)
15	GGND	RS422/485 shield		
16	+V	24V DC input for power supply	Brown	
17	0V	Power supply ground	Blue	



◆ NOTE

- There are no SD/RD lines available for the HL-G1□□-A-C5 standard types.

- **The input NP acts as a toggle switch. When the input NP is OFF, the sensor head is in NPN mode. When the input NP is ON, the sensor head is in PNP mode. However, the input NP needs to be connected BEFORE you switch the sensor head ON, otherwise it will not work.**
- **The sensor head does not automatically save any of the setting changes you make over the MI input. To maintain the changes even after the next system start, input the MI signal for 480ms or use the control panel, a serial command, or the GT touch panel.**

3.2 MI Input

The function of the MI (= multi input) signal is determined by the duration of the signal. To select a function, input the MI signal for the corresponding time t as listed in the table.

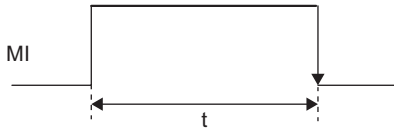

Input the MI signal for the desired period with a tolerance of $\pm 10\text{ms}$ ($t \pm 10\text{ms}$). You can input two or more MI signals consecutively if you leave a minimum interval of 10ms between the individual signals.

t	Function
30ms	Zero set ON (see page 85)
80ms	Reset (see page 85)
130ms	Select memory M0 (see page 50)
180ms	Select memory M1
230ms	Select memory M2
280ms	Select memory M3
330ms	Teach displacement judgment threshold a
380ms	Teach displacement judgment threshold b
430ms	Zero set OFF (Cancel) (see page 59)
480ms	Save (see page 46)
530ms	Laser ON (see page 78)
580ms	Laser OFF (see page 78)



◆ NOTE

The sensor head does not automatically save any of the setting changes you make over the MI input. To maintain the changes even after the next system start, input the MI signal for 480ms or use the control panel, a serial command, or the GT touch panel.

3.3 TM Input

The function of the TM (= timing) input is to control the measurement and judgment output. Depending on the timing mode you have selected (see page 77), inputting the TM signal works differently:

- When "Timing Mode" = "Hold": When the timing input is ON, the last measurement value and the judgment output is held until the timing input goes OFF.

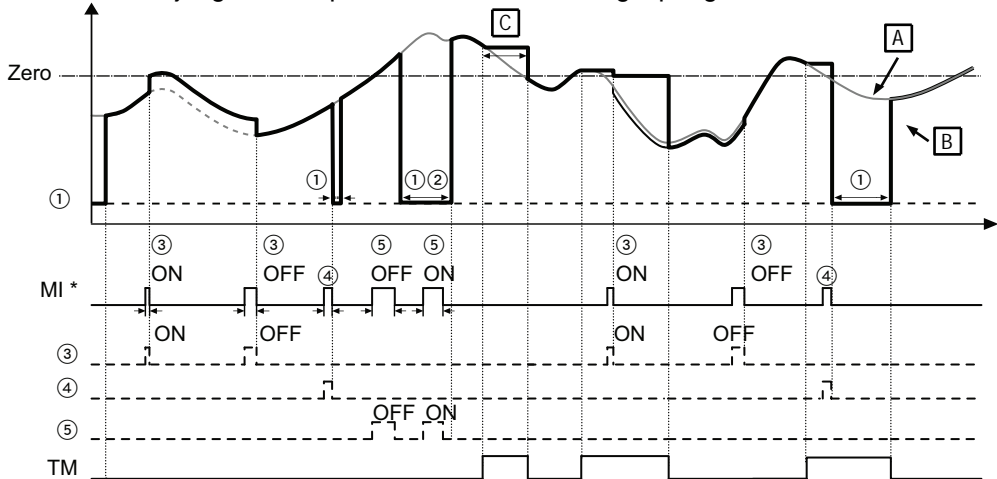

- When "Timing Mode" = "One Shot": rising edge at the timing input triggers one measurement. The measured value will be held until the timing or zero-set signal is input.

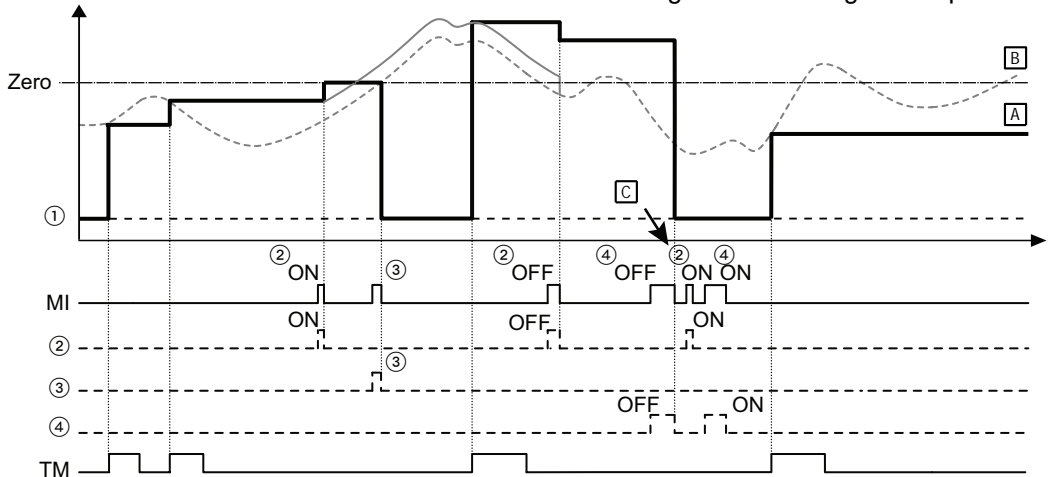

For more information on how the timing signal influences the system behavior, refer to the time diagrams (see page 33).

3.4 I/O Circuit Diagrams

PNP type

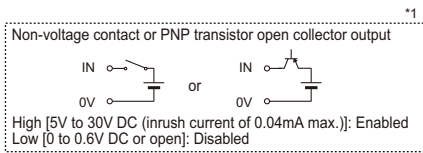
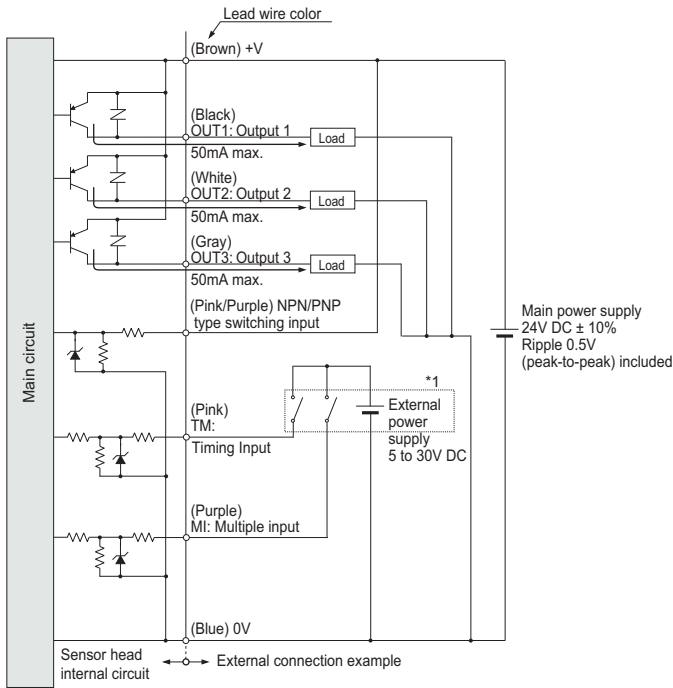

NPN type

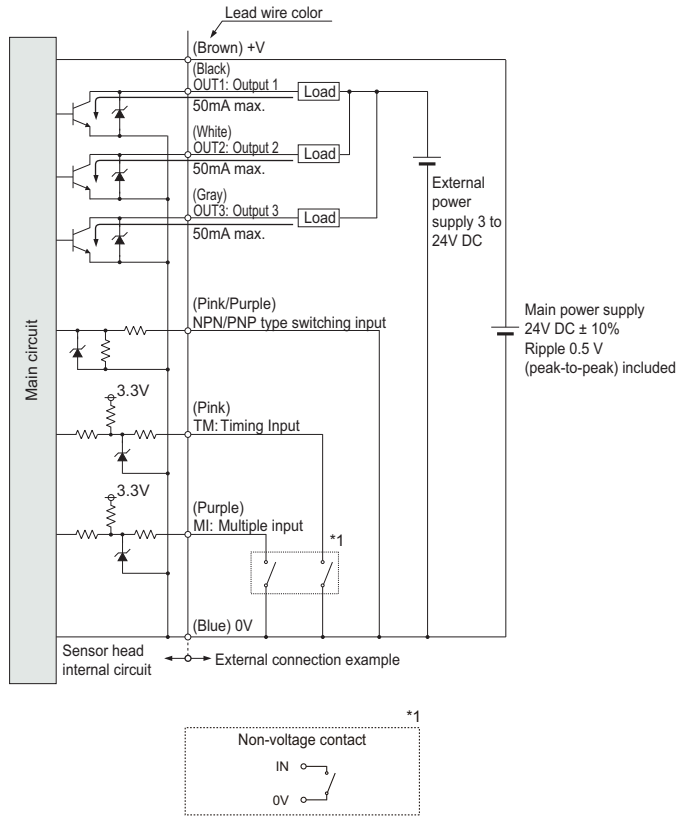

3.5 Analog Output Circuit

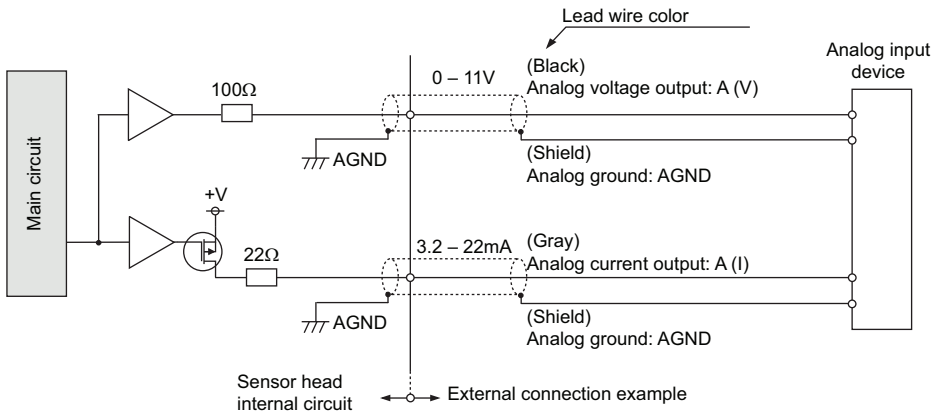

◆ NOTE

- Do not short-circuit the analog output terminals.
- Do not apply voltage to the analog output terminals.
- Use shielded wires for the analog output terminals.

3.6 When the Status of the Output Data Is Undefined

During the operation of the system it is possible that the status of the output data becomes undefined, i.e. there is no determined value to be output. This is not the same as the alarm status, when the alarm indicator lights up in orange.

The status of the output data becomes undefined under the following circumstances:

- After you have made or changed system settings when the measurement is being re-started.
- After the system has been turned on and has received a reset signal (MI signal ON for 80ms). The status of the output data will remain undefined after a reset until the sensor has performed the number of measurements needed for the average function (see page 54).
- After the laser has been stopped (MI signal ON for 580ms).
- After the sampling cycle has been switched (see page 51).
- After the system has been initialized.
- As long as the sensor has not performed the number of measurements needed for the average function.

When the output data is undefined, the system output is as follows:

- Digital output: 
- Analog output: 11.000 [V] or 21.6 [mA] (see note 1)



◆ NOTE

1. **21.6mA is the initial value. The analog output can be set to a fixed value when the status of the output data is undefined (see page 68).**
2. **While the output data status is undefined, the system will ignore the zero-set signal.**
3. **Depending on the settings, the status of the output data may not become undefined even under the circumstances listed.**

This is an example of how the status of the output data becomes undefined after a reset signal while the system is starting to measure the distance again.

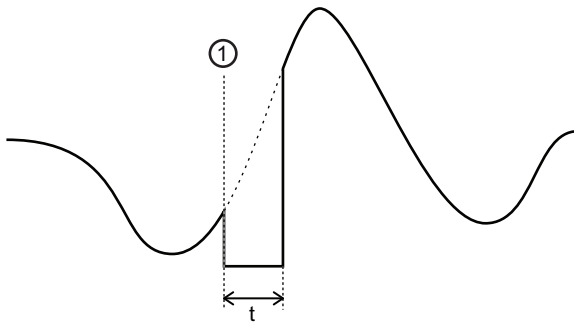

①	Reset signal (MI signal ON for 80ms)
t	Time during which the output data is undefined, i.e. time period during which the sensor measures the distance again.

This system behaves differently when the output data is undefined and when the alarm is ON (the alarm indicator is lit up in orange). Refer to the table for details on the differences.

Item	Status: Output data is undefined	Status: Alarm = ON
Description of system status	The measurement data is undefined because the sensor has not performed the number of measurements needed for the average function (see page 54).	Measurement is disabled because the light intensity is poor or because the target object is outside the measuring range.
Digital output	-999.9999 [mm]	The previous value is kept on hold (default setting) or a fixed value (+99999) is displayed (see page 69).
Analog output	The previous value is kept on hold (default setting) or a fixed value (+99999) is displayed (see page 69).	
I/O output	OFF	OFF

3.7 Time Diagrams

Depending on the measurement type and setting of the parameter "Timing Mode" (see page 77), the timing of the sensor is different.



◆ NOTE

The function of the MI input is determined by the duration (t) of the signal.

t	Function
30ms	Zero set ON (see page 85)
80ms	Reset (see page 85)
130ms	Select memory M0 (see page 50)
180ms	Select memory M1
230ms	Select memory M2
280ms	Select memory M3
330ms	Teach displacement judgment threshold a
380ms	Teach displacement judgment threshold b
430ms	Zero set OFF (Cancel) (see page 59)
480ms	Save (see page 46)
530ms	Laser ON (see page 78)
580ms	Laser OFF (see page 78)

Normal measurement with "Timing Mode" = "Hold"

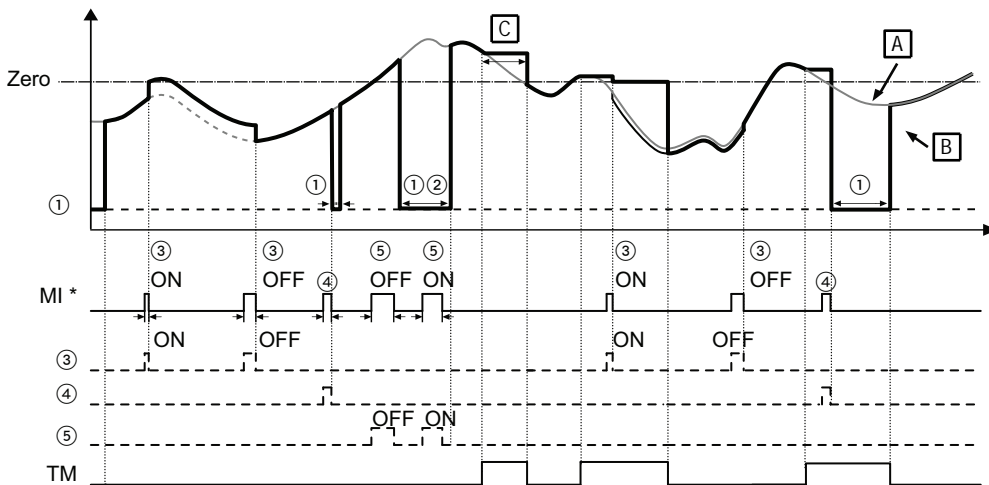

A	Sensor measurement
B	Sensor measurement and output
C	Data is kept on hold by TM signal
MI	Function of MI input depends on signal duration, see table at the top
①	Output data status is undefined
②	Laser has stopped

③	Zero-set function
④	Reset function
⑤	Laser operation

Normal measurement with "Timing Mode" = "One-Shot"

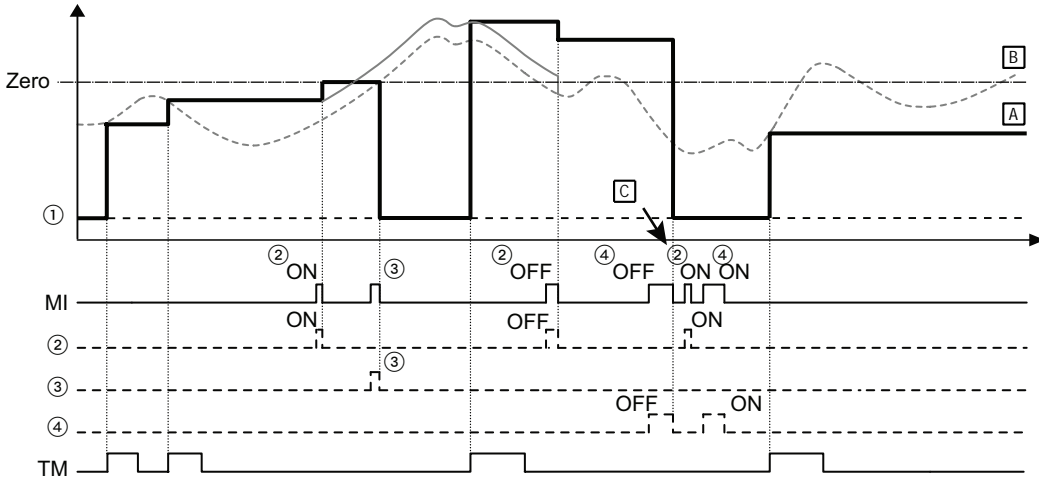

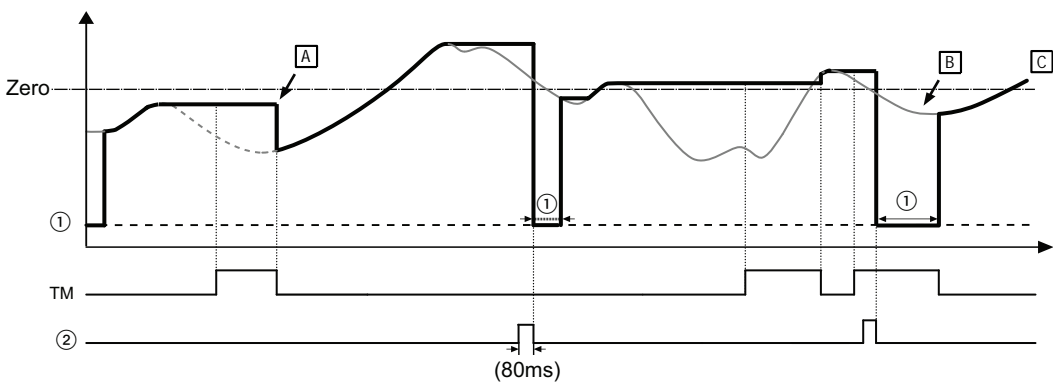

A	Sensor measurement
B	Sensor measurement and output
C	Zero-set signal is ignored because the output data status is undefined
MI	Function of MI input depends on signal duration, see table at the top
①	Output data status is undefined
②	Zero-set function
③	Reset function
④	Laser operation

Peak measurement



A	Reset of measurement and output data when TM turns OFF
B	Sensor measurement

	Sensor measurement and output
	Output data status is undefined
	Reset function



◆ NOTE

1. When "Timing Mode" = "Hold", it is possible to use the set-to-zero function while the input TM is ON.
2. When "Timing Mode" = "Hold" and TM is ON, selecting the reset function with the input MI causes the output data status to become undefined and remain so until TM turns OFF.
3. While the output data status is undefined, the system will ignore the zero-set signal.
4. When the output data is undefined and TM is ON, the system holds the reset signal and the undefined data status until the input TM turns OFF.
5. The judgment output is determined by comparing the measured value with the threshold values set under "Displacement Judgment" (see page 62). The outputs will be turned OFF while the status of the output data is undefined.
6. If the status of the output data becomes undefined for a reason other than the reset signal being input, the digital display, the analog output and the judgment output will be the same.
7. When the output data status is undefined, the analog outputs revert to the initial setting.
8. When you have entered a value under "Offset", the value will be added when a zero set is executed (see page 58).
9. If you have set "Analysis Mode" to "PEAK to PEAK" and input the zero-set signal, the present measurement value will become zero. If you input the reset signal, the measurement value will start from a negative value (-).

Signal processing when more than one signal is ON

The table gives an overview of the system behavior when two signals occur at the same time.

Signal = ON	Behavior when timing signal is input (TM switches ON)	Behavior when reset signal is input
Set-to-zero signal (ON/OFF)	Sensor sets digital display to zero and outputs the analog output selected for zero.	These signals cannot occur simultaneously as both are controlled by the MI input (see page 26).
Timing signal (TM)	—	The undefined status of the output data is kept on hold.
Reset signal (MI signal ON for 80ms)	The output data status becomes undefined and will remain undefined as long as TM is ON.	—

Effect of the timing signal (TM)

Depending on which analysis (measurement) mode you have selected, the timing signal has a different effect.







Analysis mode	System behavior
Normal	When TM switches ON, the measurement value will be put on hold until TM switches OFF.
Peak / Valley	When TM switches ON, the measurement value will be put on hold until TM switches OFF. The peak / bottom value measured will be reset when TM switches OFF.
Peak to peak	When TM switches ON, the measurement value will be put on hold until TM switches OFF. The measurement values will be set to zero when TM switches OFF.

Chapter 4

Functions

4.1 Classification of Functions

In this table, all functions are classified into eight categories.

Classification	Digital display	Function
Sensing functions		Function settings for controlling the received light intensity of the sensor.
Data processing functions		Function settings for processing measurement values.
Output functions		Function settings related to output data processing.
Analog functions		Function settings related to analog output processing.
Alarm functions		Function settings related to alarm output processing.
COM functions		Function settings related to communication, see note 1.
System functions		System functions for timing and eco mode, laser control, and version information.
Buffering functions	—	Function settings related to buffering, see note 2.



◆ NOTE

- 1. COM and buffering functions are only available to the multifunction type. These functions are not available for the standard type.**
- 2. Buffering functions cannot be executed through the sensor's control panel. To set and execute buffering functions, use serial commands (see page 104).**

4.2 List of Functions and Default Settings

There are two types of settings:

1. Settings that can be saved individually per memory (i.e. 4 different sets of settings). To change to a different set of settings, select another memory (see page 50).
2. Settings that can only be saved for all memories (one set of settings applies to all memories)

Sensing functions



Function name	Description	Default setting	Type of setting
Memory selection (see page 50)	Selects the memory for editing settings. To perform measurements with the settings saved in the selected memory, you need to switch the sensor head OFF and ON again.	M0	One setting for all memories
Sampling cycle (see page 51)	Sets the sampling cycle for the measurement.	500 μ s	Individual setting per memory
Shutter time (see page 52)	Controls the receiving light intensity of the sensor.	Auto	Individual setting per memory
Light intensity monitor (see page 53)	Indicates the currently received light intensity.	---	Not applicable

Data processing functions

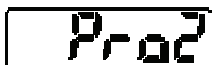

Function name	Description	Default setting	Type of setting
Average times (see page 54)	Sets the number of measurements needed for the average function.	1024	Individual setting per memory
Analysis mode (see page 56)	Sets the measuring mode.	Normal	
Span (see page 57)	Sets the multiplication factor for the measurement value.	1.0000	
Offset (see page 58)	Sets an offset value to be added to/subtracted from the measurement value.	00000mm	
Zero-set OFF (see page 59)	Works as a toggle switch for the zero-set function for measurement values.	OFF	

Output functions Pr03

Function name	Description	Default setting	Type of setting
Judgment output selection (see page 60)	Selects the output operation of OUT1 – OUT3.	2-state (OUT1 and OUT2)	Individual setting per memory
Displacement judgment (see page 62)	• Sets threshold a	+(detection range)	
	• Sets threshold b	-(detection range)	
	• Sets hysteresis	+(0.2% of setting range)	
Judgment output OFF delay (see page 63)	Delays the switching OFF of the judgment output.	OFF	
Measurement value display on panel (see page 65)	Sets the number of rightmost digits to be turned OFF on the digital display.	SET 1	

Analog functions Pr04

Function name	Description	Default setting	Type of setting
Analog output selection (see page 66)	Selects the output type for the analog output: current or voltage.	Output current	Individual setting per memory
Analog scaling (see page 67)	Scales measurement value A.	Negative measuring range	
	Scales current A.	+4.000mA	
	Scales voltage a.	0.000V	
	Scales measurement B.	Positive measuring range	
	Scales current B.	+20.000mA	
	Scales voltage b.	10.000V	

Alarm functions Pr05

Function name	Description	Default setting	Type of setting
Analog output at alarm (see page 68)	Sets the analog output behavior for when an alarm occurs.	Hold previous value	Individual setting per memory
Digital output at alarm (see page 69)	Sets the digital output behavior for when an alarm occurs.	Hold previous value	
Alarm delay (see page 70)	Sets the number of measurement attempts to be made before an alarm is output.	8 times	

COM functions

These functions are only available for the multifunction type of the sensor.

Function name	Description	Default setting	Type of setting
Terminating resistor selection (see page 71)	Selects the terminating resistor for a sensor head connected to a host device via RS422/485.	R3	One setting for all memories
Sensor number (see page 72)	Sets the number of each sensor head when several sensors have been connected to a host device via RS485.	01	
Baud rate (see page 73)	Sets the communication speed.	38400bps	
Connection mode (see page 74)	Selects the transmission settings for measurement data output to the host device.	RS422 handshake	
Sending delay time (see page 76)	Sets the delay with which the sensor responds to a serial command sent by the host device.	0 (No delay)	

System functions

Function name	Description	Default setting	Type of setting
Timing mode (see page 77)	Determines how the sensor head works when the timing input is ON.	Hold	One setting for all memories
Laser control (see page 78)	Switches the laser emission ON and OFF.	Emission ON	
Eco mode (see page 79)	Turns OFF the LED indicators on the control panel to save energy while the system is in RUN mode.	Eco OFF	
View version (see page 80)	Displays the version of the firmware.	---	

Buffering functions

These functions are only available for the multifunction type of the sensor. Buffering settings cannot be made via the control panel. All settings need to be made by serial commands.

Function name	Description	Default setting	Type of setting
Buffering mode (see page 80)	Sets the buffering mode	Continuous mode	One setting for all memories
Buffering rate (see page 80)	Sets the reduction rate for measurement data during data accumulation.	10 (i.e. every 10th value is buffered)	
Data amount (see page 80)	Sets the amount of data to be accumulated.	3000 data items	
Trigger point (see page 80)	Sets the measurement data as the trigger point for buffering (only valid if "Buffering Mode" is set to "Trigger").	300	

Function name	Description	Default setting	Type of setting
Trigger delay (see page 80)	Sets a delay time for trigger detection (only valid if "Buffering Mode" is set to "Trigger").	0	
Trigger condition (see page 80)	Sets the condition which is used to generate the trigger for buffering (only valid if "Buffering Mode" is set to "Trigger").	ON	
Buffering operation (see page 80)	By default, buffering is performed continuously with the parameters set in advance.	Select "Stop" to stop buffering.	
Status readout (see page 80)	Checks the status of the buffering.	Non-buffering	Not applicable
Last data point (see page 80)	Reads out the accumulation status from the amount of measurement data.	---	
Binary readout of buffering data (see page 80)	Reads out the accumulated data.	---	

Other functions

Function name	Description	Default setting	Controlled by
Initialize (see page 45)	Initializes the memory settings currently in use.	---	Keys on control panel
Save (see page 46)	Saves all settings stored in the memories 0 to 3.	---	MI input
Timing (see page 27)	Holds the measurement value.	OFF	TM input
Zero set (see page 85)	Sets the measurement value to zero.	---	MI input
Reset (see page 85)	Resets the measurement value.	OFF	MI input



◆ NOTE

- **COM and buffering functions are only available to the multifunction type. These functions are not available for the standard type.**
- **Buffering functions cannot be executed through the sensor's control panel. To set and execute buffering functions, use serial commands (see page 104).**
- **Each function setting is saved in either one of the following ways:**
 - Via the control panel of the sensor head: Press the [ENTER] key to save the new function setting when you have changed it.
 - Via a serial command (multifunction type only)
- **If you are using the setting and monitoring software HL-G1SMI on a GN touch panel (sold separately), you must execute the "Save" command after changing a function setting.**

4.3 Control Panel and Digital Display

The measurement functions of the sensor are controlled via the control panel. The currently selected function or setting is shown in the digital display.



◆ **NOTE**

In order to ensure the performance of the system, allow a warm-up time of at least 30 minutes after the system is turned ON.

The control panel of the sensor head looks as shown below.

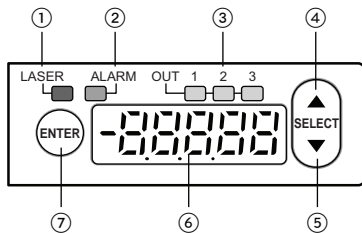

①	Laser indicator (LASER) Lights up in green during laser emission.
②	Alarm indicator (ALARM) Lights up in orange if an alarm occurs during measurement.
③	OUT1/OUT2/OUT3 indicator Lights up in yellow during output
④	[UP] key Used to select items or change numerical values.
⑤	[DOWN] key Used to select items or change numerical values.
⑥	Digital display Displays measurement values and system errors.
⑦	[ENTER] key Used to access the functions and to confirm input.

The digital display has the following properties and functions:

Item	Description	Sensor type	Digital display
Decimal point	The position of the decimal point varies with each model.	• 30mm type	
		• 50/80/120mm type	
Undefined status of output data	The status of the output data may become undefined under certain conditions (see page 31).	All types	

Item	Description	Sensor type	Digital display
Alarm status	The function "Digital Output at Alarm" (see page 69) can be set to a fixed value.	• 30mm type	
		• 50/80/120mm type	

4.3.1 Basic Operation

The following section explains how to operate the sensor after you switch it ON.

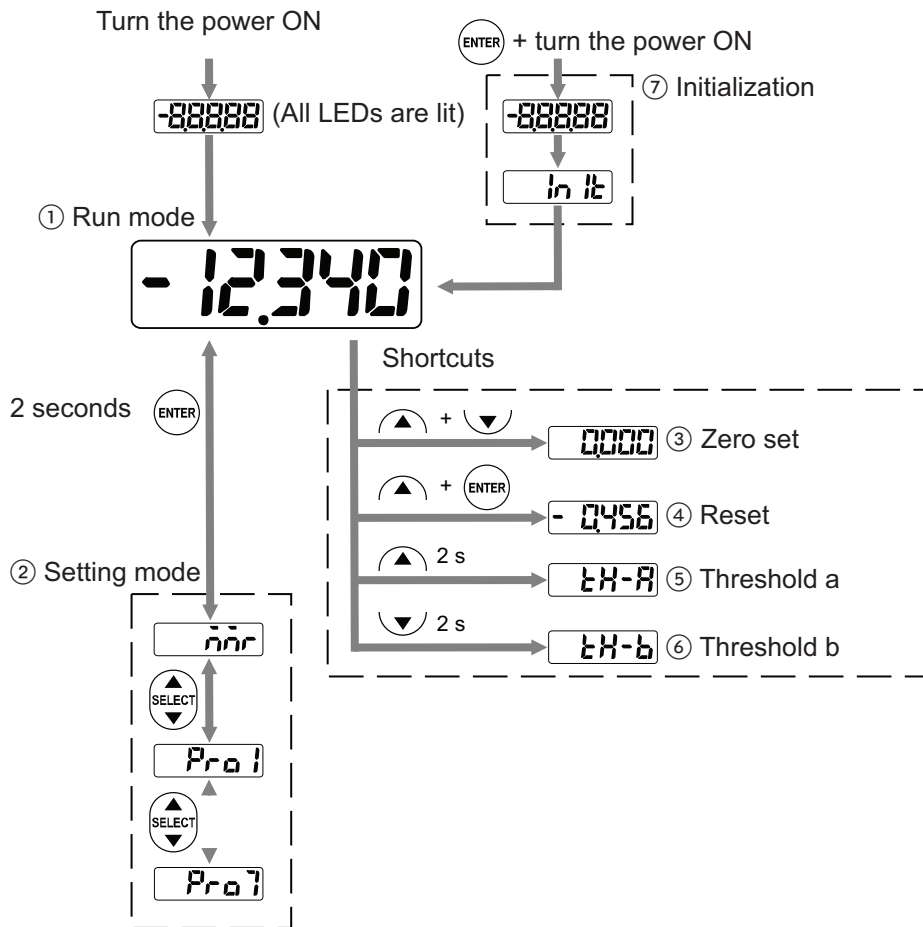

①	<p>Run mode</p> <p>Standard mode after switching ON the sensor. The current measurement value appears in the digital display. The sensor can receive write and read commands via RS422/RS485 while in run mode.</p>
②	<p>Setting mode</p> <p>Use this mode to change the function settings.</p> <p>Note: The sensor cannot receive write and read commands via RS422/RS485 while in setting mode. When the sensor receives a write command while in setting mode, the digital display shows an error message.</p>

③	Zero set (see page 85) Sets the measurement value in the digital display as zero.
④	Reset (see page 85) Resets the measurement value kept on hold by the sensor.
⑤	Threshold a (see page 62) Sets an upper limit for judging the measurement value.
⑥	Threshold b (see page 62) Sets a lower limit for judging the measurement value.
⑦	Initialize (see page 45) Resets all settings to the default settings.

How to change numerical values

To change numerical values on the digital display, please proceed as follows:

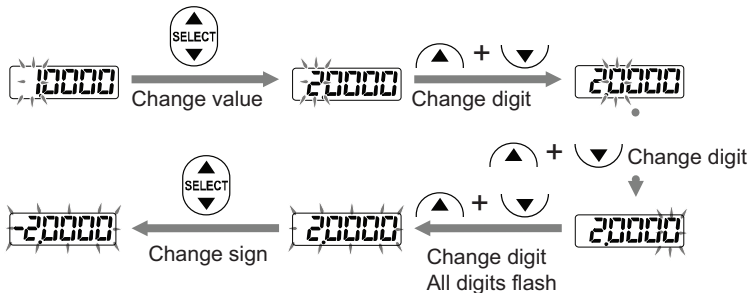



◆ NOTE

After you have changed the settings for a memory, you need to switch the sensor head OFF and then ON again to work with the memory and its changed settings.

4.3.1.1 Initialize

This function is used to delete all the settings from all the memories and returns them to the default settings.

- You need to save the settings after initialization (see page 46), or the system will operate with the settings valid before the initialization at the next system start.
- When the initialization of the system is executed through the operation of the panel, all settings except COM settings  and system settings  will return to the factory default settings.
- When you are using the multifunction type and initialize the settings with a serial command, send the "Save" command immediately afterwards, or the

system will operate with the settings valid before the initialization at the next system start.

- While the initialization is executed, the output data status may become undefined temporarily.



◆ Procedure

1.  + switch power ON

After the start-up screen, the digital display shows "Init".

The memory is initialized and the system is set to RUN mode



4.3.1.2 Save

There are different methods to save setting changes permanently so that after a system restart the new settings are applied:

- In the control panel of the sensor head: Access the option to be changed via the function menu and confirm the change with .
- With the MI input: Input the MI signal for 480ms to save the current settings (see page 26).



◆ NOTE

- It is not possible to save the state of the timing input (TM). The timing input will be OFF right after the system is switched ON or when you select a different memory.
- When you change settings with a serial command, a dedicated console (sold separately), or the setting and monitoring software HL-G1SMI, you need to save the changes and restart the system, or the system will operate with the old settings valid before the change at the next system start.

4.3.2 Function Menu in Setting Mode

Access the functions by pressing the [ENTER] key on the control panel (see page 43) for 2 seconds. The currently selected function or setting is shown in the digital display.

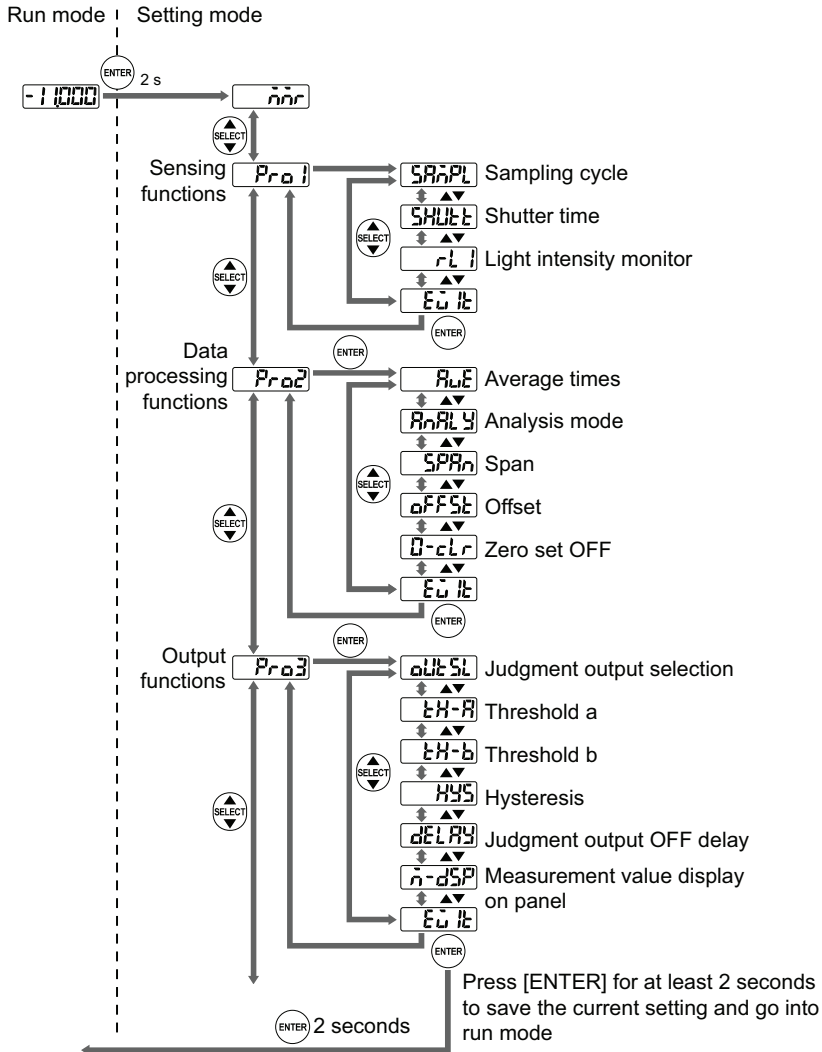

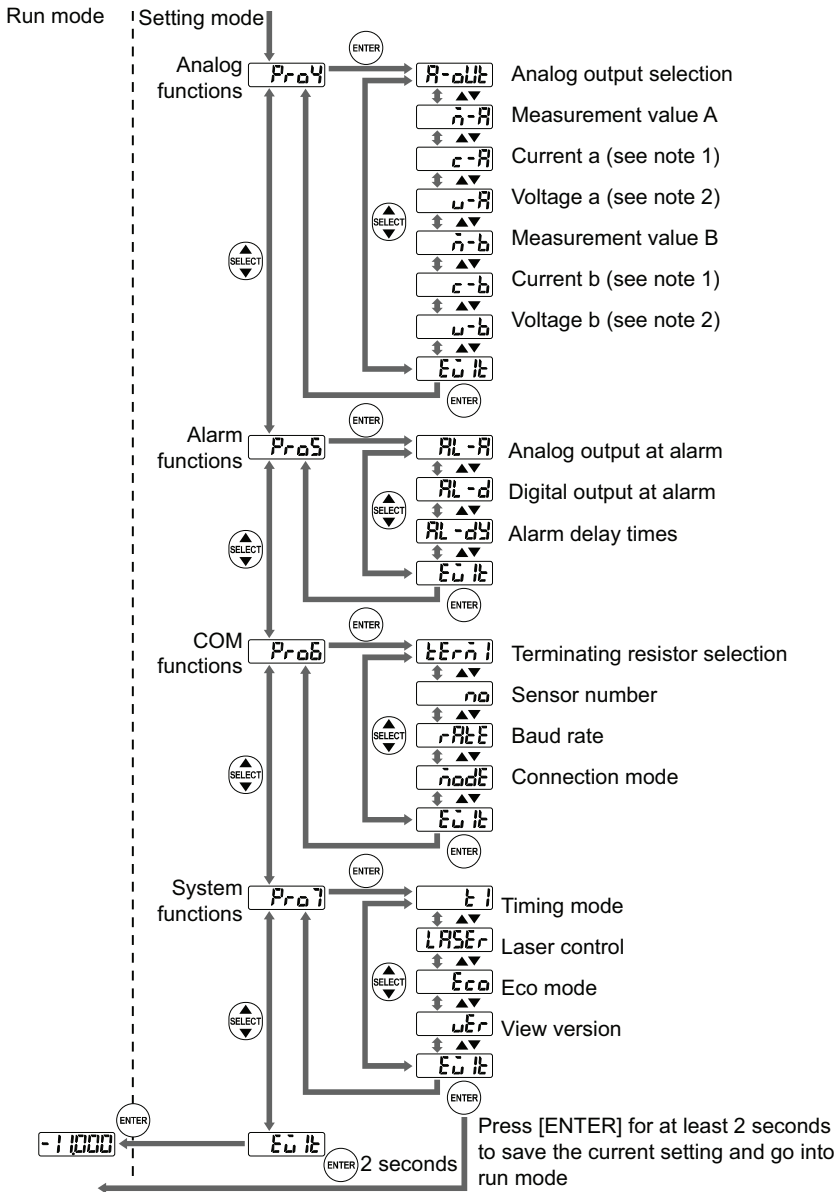







◆ NOTE

1. Available, when "Analog Output Selection" is set to "Voltage"
2. Available when "Analog Output Selection" is set to "Current"

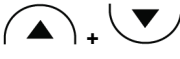
4.3.3 Shortcuts

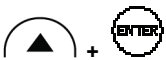
Some sensor functions can be accessed quickly with the help of a shortcut. This way, you do not have to navigate through the complete function menu to make settings.

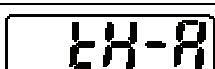
The following shortcuts are available:

Shortcut keys	Function name	Description	Digital display
	Zero set (see page 85)	Sets the measurement value in the digital display as zero.	
	Reset (see page 85)	Resets the measurement value kept on hold by the sensor.	
	Threshold a (see page 62)	Sets an upper limit for judging the measurement value.	
	Threshold b (see page 62)	Sets a lower limit for judging the measurement value.	

4.4 Function Settings

The following sections provide detailed information on how to set and use the functions.

4.4.1 Memory Selection



Selects the memory for editing settings. To perform measurements with the settings saved in the selected memory, you need to switch the sensor head OFF and ON again.

The sensor has 4 memories, M0 to M3, that act as user profiles for saving different sets of measurement settings individually. The bold table entry indicates the default setting.

Setting	Function	Digital display
M0	Memory M0	
M1	Memory M1	
M2	Memory M2	
M3	Memory M3	



◆ Procedure

1. 2s
- 2.
3. 3x
4. to confirm



◆ NOTE

- When you switch the sensor head ON, it will load the settings from the memory that has been used last.
- Before you change parameter settings, make sure you have selected the right memory.

- After you have changed the settings for a memory, you need to switch the sensor head OFF and then ON again to work with the memory and its changed settings.
- Selecting a different memory may result in a status when the output data is undefined (see page 31).
- If setting changes are made with a serial communications command, save the changes so that the changes will be reflected when the system is turned ON again. To save the changes, use the panel, a serial command, or the GT touch panel.
- You can use the MI input to select a different memory (see page 26).

4.4.2 Sensing Functions



This function menu contains settings for controlling the received light intensity of the sensor.

4.4.2.1 Sampling Cycle



Sets the sampling cycle for the measurement.



◆ NOTE

When measuring an object with poor reflective properties such as black rubber, make the sampling cycle longer to receive sufficient light for a stable measurement.

The bold table entry indicates the default setting.

Cycle	Frequency	Digital display	Object properties
200µs	5kHz		bright objects
500µs	2kHz		
1ms	1kHz		
2ms	500Hz		



◆ Procedure

1. 2s
2.
3.
4.
5.
6. to confirm

4.4.2.2 Shutter Time



Controls the receiving light intensity of the sensor.

Depending on the properties of the object to be measured, the amount of reflected light differs. If the shutter time is set to "Auto", the light intensity feedback function automatically modifies the light intensity to an optimum level. If you want to use a fixed shutter time, check the light received by the sensor with the light intensity monitor (see page 53). The light intensity is good when the light intensity monitor displays a value from approximately 1000 to 1300.

Setting	Function	Default setting
Auto	Automatically set shutter time	
1 to 31	Fixed to a percentage of the sampling cycle (see page 51) you have selected, see the table below.	

Setting	Shutter aperture	Setting	Shutter aperture	Setting	Shutter aperture	Setting	Shutter aperture
Auto	Automatic	8	0.24%	16	1.95%	24	15.9%
1	0.04%	9	0.31%	17	2.54%	25	20.7%
2	0.05%	10	0.40%	18	3.30%	26	26.9%
3	0.06%	11	0.53%	19	4.29%	27	35.0%
4	0.08%	12	0.68%	20	5.58%	28	45.5%
5	0.11%	13	0.89%	21	7.25%	29	59.2%
6	0.14%	14	1.16%	22	9.43%	30	76.9%
7	0.18%	15	1.50%	23	12.3%	31	100%



◆ Procedure

- | | | | |
|----|--|------------|--|
| 1. | | 2s | |
| 2. | | | |
| 3. | | | |
| 4. | | | |
| 5. | | | |
| 6. | | | |
| 7. | | to confirm | |

4.4.2.3 Light Intensity Monitor

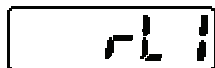

Indicates the currently received light intensity.

The peak light intensity will be displayed in a range of 0 to 4095. The light intensity is good when the light intensity monitor displays a value from approximately 1000 to 1300.



◆ Procedure

- | | | | |
|----|--|--|--|
| 1. | | 2s | |
| 2. | | | |
| 3. | | | |
| 4. | | x2 | |
| 5. | | to display the current light intensity | |

4.4.3 Data Processing Functions

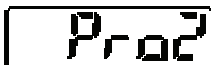

This function menu contains settings for processing measurement values.

4.4.3.1 Average Function

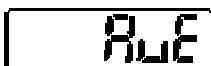

Sets the number of measurements needed for the average function. Use the function to stabilize unstable measurement values and to eliminate variations.

This function works as a moving average function with FIFO. For example, if you have selected the setting "4", it means that the sensor takes 4 measurements (M-1 to M-4), calculates the average and outputs the average. Next, M-1 is discarded, and the sensor moves the averaging "window" by discarding M-1 and adding M-5 so that averaging takes place with M-2 to M-5, see figure below.

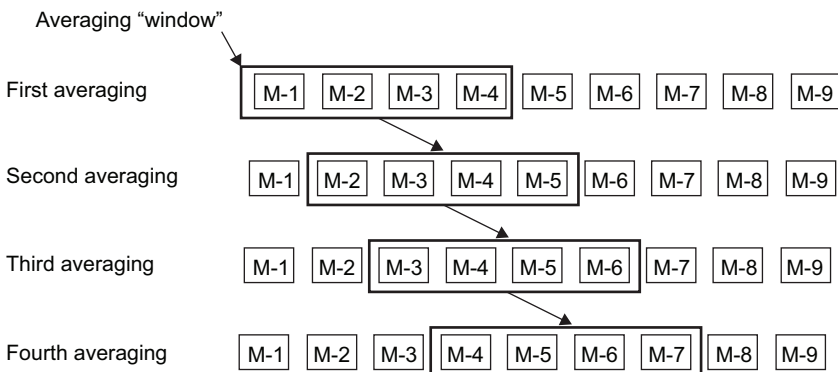

The bold table entry indicates the default setting.

Setting	Function	Digital display
1 value	Moving average calculated from 1 value. This means every measurement value will be output.	1
4 values	Moving average calculated from 4 values.	4
16 values	Moving average calculated from 16 values.	16
64 values	Moving average calculated from 64 values.	64
256 values	Moving average calculated from 256 values.	256
1024 values	Moving average calculated from 1024 values.	1024



◆ **NOTE**

- Until the moving-average buffer reaches the number of values set here, the output data status is undefined (see page 31).
- An alarm will prevent the sensor from storing measurement values in the moving-average buffer. That means, if an alarm occurs and the moving-average buffer is empty, the alarm has to be turned OFF before the moving-average buffer starts to buffer measurement values. If an alarm occurs when the moving-average buffer already contains some, but not all measurement values needed to calculate the average, the alarm has to be turned OFF before the moving-average buffer will continue to buffer measurement values.



◆ **Procedure**

1.		2s	
2.			
3.			
4.			
5.			
6.			
7.		to confirm	

4.4.3.2 Analysis Mode (Measuring Mode)



Sets the measuring mode.

There are 4 measuring modes available. The bold table entry indicates the default setting.

Setting	Sample measurement	Function	Digital display
NORMAL		The measurement value is output in real time.	nor
PEAK		Holds and outputs the maximum measurement value.	PEAK
VALLEY		Holds and outputs the minimum measurement value.	VALLEY
PEAK to PEAK (P-P)		Holds and outputs the difference between the maximum and minimum values (see note).	P-P



◆ NOTE

Use the measuring mode "Peak to peak" for vibration or eccentricity measurement.



◆ Procedure

1. 2s
- 2.
- 3.
- 4.
- 5.

- 6.  3x P-2-P
- 7.  to confirm ANALY

4.4.3.3 Span



Sets the multiplication factor for the measurement value.

The formula for calculating the value to output is:

$$\text{final measurement value} = \text{span} \times \text{measurement value} + \text{offset}$$

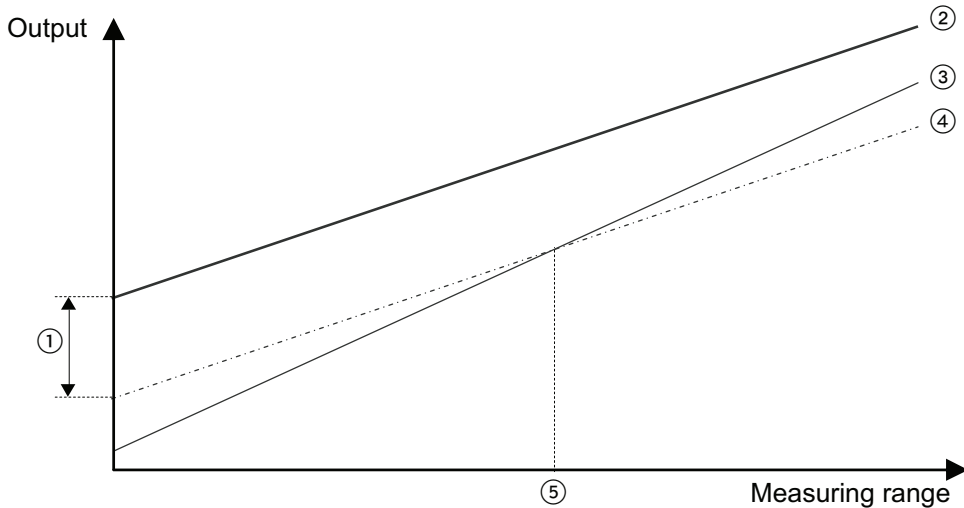

①	Offset value
②	Final measurement value
③	Measured value
④	Spanned measured value
⑤	Center point of measurement











Setting range	Function	Default setting
0.1000 to +9.9999	Set a factor in the range from 0.1000 to +9.9999.	10000









◆ Procedure

- 1.  2s



2.  
3.  
4.  
5.  3x 
6.  to display the current scaling factor 

The leftmost digit is selected. Press  and  together to select the next digit. 
7.  to change the selected digit 
8.  to confirm 

4.4.3.4 Offset

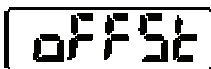

Sets an offset value to be added to/subtracted from the measurement value.

Setting range	Function	Default setting
-95000 to +95000	Set an offset in a range from 95000 to +95000. (The position of the decimal point varies with each model.)	



◆ NOTE

- To use the size of a master workpiece as an offset, measure it with the sensor and then input the set-to-zero signal.
- Set "Offset" and turn "Zero Set" ON to make the setting value an offset value.
- The display limit of the measurement value is ± 95000 . Make sure that the setting value does not exceed the display limit.



◆ Procedure

- | | |
|---|----------------------------------|
| <p>1. 2s</p> <p>2. </p> <p>3. </p> <p>4. </p> <p>5. 3x</p> <p>6. </p> <p>The leftmost digit is selected. Press and together to select the next digit.</p> <p>7. to change the selected digit</p> <p>8. to confirm</p> |

 |
|---|----------------------------------|

4.4.3.5 Zero-set OFF

Works as a toggle switch for the zero-set function for measurement values.

Setting	Function	Digital display
Zero set is ON	The reset signal will set the display to 00000.	
Zero set is OFF	The displays shows the current measurement value.	



◆ NOTE

You can use the MI signal (see page 26) to turn this function ON and OFF.



◆ Procedure

1.	2s	
2.		
3.		
4.		
5.	4x	
6.		
7.	or	
8.	to confirm	

4.4.4 Output Functions



This function menu contains settings related to output data processing.

4.4.4.1 Judgment Output Selection









Selects the output operation of OUT1 – OUT3.

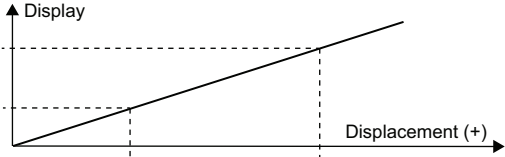

◆ NOTE

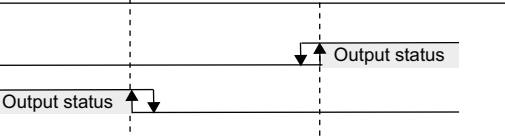

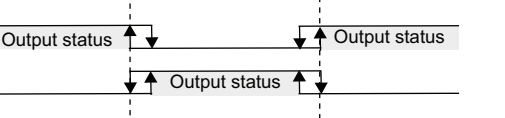

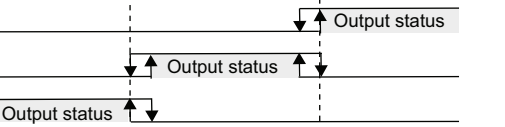







- **OUT3 usually serves as the alarm output. If you select the setting "3-state", alarms will not be output, as OUT3 will be used for the third judgment result. In this case, check the alarm state with the alarm indicator and alarm read-out function.**
- **When an alarm has occurred, the sensor displays +999.9999 (only if you have set "Digital Output at Alarm" to "Fixed Value"). Whether the alarm will be output via OUT3 or not, depends on the setting of this function.**

The bold table entry indicates the default setting.

Setting	OUT1	OUT2	OUT3	Threshold a	Threshold b	Display
Logic 	Judgment 1	Judgment 2	Alarm	OUT1	ON OFF	
Independent 	Judgment 1	Judgment 2	Alarm	OUT1	ON OFF	
2-state 	Judgment 1	Judgment 2	Alarm	OUT1	ON OFF	
3-state 	Judgment 1	Judgment 2	Judgment 3	OUT1 (HI)	ON OFF	



◆ Procedure

1.  2s 
2.  3x 
3.  
4.  
5.  or  
6.  to confirm 

4.4.4.2 Displacement Judgment

Sets an upper limit (threshold a), a lower limit (threshold b), and the hysteresis for the judgment of measurement values.

Item	Digital display	Setting range
Threshold a		-95000 to +95000
Threshold b		-95000 to +95000
Hysteresis		0 to +95000

The following default values apply:

Measurement center distance	Threshold a	Threshold b	Hysteresis
30mm	+4mm	-4mm	8μm
50mm	+10mm	-10mm	20μm
85mm	+20mm	-20mm	40μm
120mm	+60mm	-60mm	120μm



Procedure

1. 2s
 2. 3x
 - 3.
 - 4.
 5. to display the current threshold
- The leftmost digit is selected. Press and together to select the next digit.
6. to change the selected digit
 7. to confirm



◆ NOTE

- Threshold a needs to be larger than threshold b. However, if the user enters the values the wrong way round, the sensor will automatically use the lower value as threshold b.
- The position of the decimal point varies with each model.

4.4.4.3 Judgment Output OFF Delay



Delays the switching OFF of the judgment output.



◆ NOTE

This function is useful when the judgment output needs to be transmitted to a control device, but changes too quickly.

The bold table entry indicates the default setting.

Setting	Function	Digital display
OFF	Output according to the sampling cycle	
2ms	Delays switching OFF the judgment output by 2ms.	
4ms	Delays switching OFF the judgment output by 4ms.	
10ms	Delays switching OFF the judgment output by 10ms.	
20ms	Delays switching OFF the judgment output by 20ms.	
40ms	Delays switching OFF the judgment output by 40ms.	
100ms	Delays switching OFF the judgment output by 100ms.	
Hold	Once the output has been switched ON, it will be kept on hold. To release an output kept on hold, you need to input the reset signal.	

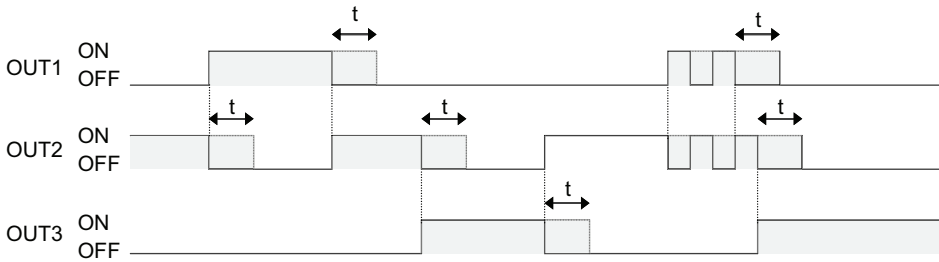

The solid lines shows when the turn-OFF signal is input. The dotted lines show how the time t set with this function delays the switching OFF of the judgment output.



◆ **NOTE**

- If an output has not turned OFF yet because the delay time has not elapsed, and the output receives the next ON signal, the delay will be canceled even though it has not been completed. The output stays ON until the delay time after the next OFF signal has elapsed.
- If "Judgment Output Selection" is set to "Logic", "Independent", or "2-state", OUT3 serves as the alarm output and will switch OFF without delay, regardless of the settings made here.



◆ **Procedure**

- | | | |
|----|------------------------------|--|
| 1. | 2s | |
| 2. | 3x | |
| 3. | | |
| 4. | 3x | |
| 5. | | |
| 6. | to change the selected digit | |
| 7. | to confirm | |

4.4.4.4 Measurement Value Display on Panel



This function sets the number of rightmost digits to be turned OFF on the digital display.

The bold table entry indicates the default setting.

Setting	Function	Digital display	Example
FULL	All digits are displayed.		
Set 1	The rightmost digit is OFF.		
Set 2	The two rightmost digits are OFF.		



Procedure

1. 2s
2. 3x
- 3.
4. 5x
- 5.
6. or to change the setting
7. to confirm

4.4.5 Analog Functions



This function menu contains settings related to analog output processing.

4.4.5.1 Analog Output Selection



Selects the output type for the analog output: current or voltage

The selected analog output will be accurate. The bold table entry indicates the default setting.

Setting	Function	Digital display
Current	Output current	I-out
Voltage	Output voltage	V-out



◆ Procedure

1. 2s
2.
3.
4.
5. or to change the setting
6. to confirm

4.4.5.2 Analog Scaling

This function scales the current or voltage to any value.

Any two measurement values can be used for A and B. Set which current or voltage to output for measurement value A and B. The analog output for measurement values between A and B will be interpolated, see figure below.

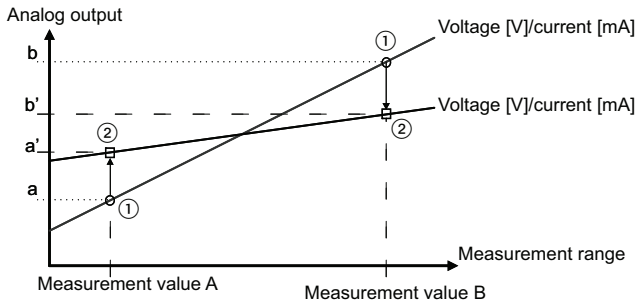

Item	Digital display	Setting range	Default setting
Measurement value A		-95000 to 95000	Negative measuring range, see table below
Measurement value B		-95000 to 95000	Positive measuring range, see table below
Current a (note 1)		+4.000 to 20.000	
Current b (note 1)		+4.000 to 20.000	
Voltage a (note 2)		0 to +10.000	
Voltage b (note 2)		0 to +10.000	



◆ **NOTE**

1. Not displayed when "Analog Output Selection" is set to "Voltage".
2. Not displayed when "Analog Output Selection" is set to "Current".

The following default measurement values A and B apply.

Measurement center distance	Measurement value A	Measurement value B
30mm	-4mm	+4mm
50mm	-10mm	+10mm
85mm	-20mm	+20mm
120mm	-60mm	+60mm



◆ **NOTE**

- The display limit of the measurement value is ± 95000 . Make sure that the setting value does not exceed the display limit.
- Before you make a setting, check the input range of your input device, e.g. an AD board.
- The position of the decimal point varies with each model.



◆ **Procedure**

1.		2s	
2.			
3.			
4.		2x	
5.			
		The leftmost digit is selected. Press and together to select the next digit.	
6.		to change the selected digit	
7.		to confirm	

4.4.6 Alarm Functions

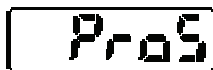

This function menu contains settings related to alarm output processing.

4.4.6.1 Analog Output at Alarm



Sets the analog output behavior for when an alarm occurs.

When an alarm has occurred, for example when the sensor cannot measure the distance because it is too dark, the analog output can be kept on hold or set to a fixed value. The bold table entry indicates the default setting.

Setting	Function	Digital display
Hold	Holds the analog output immediately before the alarm.	Hold
Fixed value	The analog output depends on the setting for the analog output (see page 66). <ul style="list-style-type: none"> • 21.6mA for current output • +11.000V for voltage output 	Flu



◆ Procedure

1. 2s
2. 5x
3.
4.
5. or to change the setting
6. to confirm

4.4.6.2 Digital Output at Alarm



Sets the digital output behavior for when an alarm occurs.

When an alarm has occurred, for example when the sensor cannot measure the distance because it is too dark, the digital output can be kept on hold or set to a fixed value. The bold table entry indicates the default setting.

Setting	Function	Digital display
Hold	Holds the digital output immediately before the alarm.	Hold
Fixed Value	Outputs a fixed value: <ul style="list-style-type: none"> • 9.9999 (30mm type) • 99.999 (50/80/120mm type) 	Flu



◆ Procedure

- | | |
|---|---|
| <p>1. 2s</p> <p>2. 5x</p> <p>3. </p> <p>4. </p> <p>5. </p> <p>6. or to change the setting</p> <p>7. to confirm</p> | <div style="border: 1px solid black; padding: 2px; width: fit-content; margin-bottom: 5px;">n̄n̄r</div> <div style="border: 1px solid black; padding: 2px; width: fit-content; margin-bottom: 5px;">Pras</div> <div style="border: 1px solid black; padding: 2px; width: fit-content; margin-bottom: 5px;">AL - A</div> <div style="border: 1px solid black; padding: 2px; width: fit-content; margin-bottom: 5px;">AL - d</div> <div style="border: 1px solid black; padding: 2px; width: fit-content; margin-bottom: 5px;">Hold</div> <div style="border: 1px solid black; padding: 2px; width: fit-content; margin-bottom: 5px;">F 10</div> <div style="border: 1px solid black; padding: 2px; width: fit-content;">AL - d</div> |
|---|---|

4.4.6.3 Alarm Delay

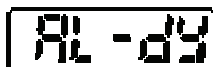

Sets the number of measurement attempts to be made before an alarm is output.

When an alarm occurs, for example because measurement was not possible due to lack of light, it will not be output immediately. Instead, the sensor holds and displays the last normal measurement value until the number of times set here has been reached. When the number of times set here has been exceeded, the alarm output (OUT3) will be turned ON. The analog and the digital output will be turned ON according to the setting for analog output at alarm and the setting for digital output at alarm, respectively.



◆ NOTE

This function is useful if you do not require an alarm output as soon as the surface of measured objects changes.

Setting range	Function	Initial value
0 to 65534	0 (OFF) to 65534 times	
65535	Holds the last measurement value before the alarm occurred.	



◆ Procedure

- | | |
|---|---|
| <p>1. 2s</p> <p>2. 5x</p> <p>3. </p> <p>4. 2x</p> <p>5. </p> | <div style="border: 1px solid black; padding: 2px; text-align: center; width: fit-content; margin-bottom: 5px;">nnc</div> <div style="border: 1px solid black; padding: 2px; text-align: center; width: fit-content; margin-bottom: 5px;">Pras</div> <div style="border: 1px solid black; padding: 2px; text-align: center; width: fit-content; margin-bottom: 5px;">AL-A</div> <div style="border: 1px solid black; padding: 2px; text-align: center; width: fit-content; margin-bottom: 5px;">AL-dY</div> <div style="border: 1px solid black; padding: 2px; text-align: center; width: fit-content; margin-bottom: 5px;">00008</div> |
| <p>The leftmost digit is selected. Press and together to select the next digit.</p> | |
| <p>6. to change the selected digit</p> <p>7. to confirm</p> | <div style="border: 1px solid black; padding: 2px; text-align: center; width: fit-content; margin-bottom: 5px;">00008</div> <div style="border: 1px solid black; padding: 2px; text-align: center; width: fit-content; margin-bottom: 5px;">00000</div> <div style="border: 1px solid black; padding: 2px; text-align: center; width: fit-content;">AL-dY</div> |

4.4.7 COM Functions (Multifunction Type Only)



This function menu is available only for the multifunction type and is used for serial communication.

4.4.7.1 Terminating Resistor Selection



Selects the terminating resistor for a sensor head connected to a host device via RS422/485.



◆ NOTE

- Select R3 if the system is connected to other equipment via RS422.
- If multiple sensor heads are connected to other equipment via RS485, set R3 for the terminating sensor and the rest of the sensors to OFF.
- If the RS422/485 communication is unstable, select R1 or R2.

Setting	Function	Digital display
OFF	Turn OFF terminating resistors	
R1	Terminating resistor R1	
R2	Terminating resistor R2	
R3	Terminating resistor R3	



◆ Procedure

1. 2s
2. 6x
- 3.
- 4.
5. or to change the setting
6. to confirm

4.4.7.2 Sensor No.

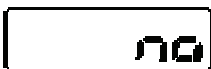

Sets the number of each sensor head when several sensors have been connected to a host device via RS485.



◆ NOTE

Set a unique number for each connecting sensor so that there are no duplicate numbers.

Setting range	Function	Default setting
01 to 16	Set sensor numbers 01 through 16 in sequence.	



◆ Procedure

- | | |
|--|--|
| 1. 2s | |
| 2. 6x | |
| 3. | |
| 4. | |
| 5. | |
| 6. or to change the setting (see note) | |
| 7. | |



◆ NOTE

Press and together for at least 2s to change the number at high speed.

4.4.7.3 Baud Rate



Sets the communication speed.



◆ NOTE

Lower the communication speed if the communication with the host device is not stable.

Setting	Function	Digital display
9600	9,600bps	
9200	19,200bps	

Setting	Function	Digital display
38400	38,400bps	
115200	115,200bps	
230400	230,400bps	
460800	460,800bps	
921600	921,600bps	



◆ Procedure

- | | |
|-------------------------------|--|
| 1. 2s | |
| 2. 6x | |
| 3. | |
| 4. 2x | |
| 5. | |
| 6. or to change the setting | |
| 7. | |

4.4.7.4 Connection Mode



Selects the transmission settings for measurement data output to the host device.



◆ NOTE

- For connection mode RS422, the host device needs to be connected for 1:1 communication (see page 89).

- For connection mode RS485, the host device needs to be connected for 1:n communication (see page 90). You can connect up to 16 sensor heads this way.

Setting	Connection mode	Function	Digital display
RS422 Handshake	RS422	Transmits the result data in response to a request command from the host device. All commands can be received.	422-1
RS422 Timing		Outputs the measured value in the serial output format (see page 101) when timing input is ON while the system is in this mode.	422-2
RS422 Continuous		Transmits the measured value continuously in the exclusive output format after this mode is selected.	422-3
RS485 Multiple	RS485	Up to 16 sensor heads are connected to the host device. Transmits the result data in response to a request command from the host device. No sensors outside the designated range will respond.	485-n



◆ Procedure

- | | |
|--|--|
| <p>1. 2s</p> <p>2. 6x</p> <p>3. </p> <p>4. 3x</p> <p>5. </p> <p>6. or to change the setting</p> <p>7. to confirm</p> | <div style="border: 1px solid black; padding: 2px; width: 100px; height: 20px; margin-bottom: 5px;">n̄n̄r</div> <div style="border: 1px solid black; padding: 2px; width: 100px; height: 20px; margin-bottom: 5px;">Pr̄o6</div> <div style="border: 1px solid black; padding: 2px; width: 100px; height: 20px; margin-bottom: 5px;">t̄Ēr̄n̄1</div> <div style="border: 1px solid black; padding: 2px; width: 100px; height: 20px; margin-bottom: 5px;">n̄o6Ē</div> <div style="border: 1px solid black; padding: 2px; width: 100px; height: 20px; margin-bottom: 5px;">422-1</div> <div style="border: 1px solid black; padding: 2px; width: 100px; height: 20px; margin-bottom: 5px;">485-n̄</div> <div style="border: 1px solid black; padding: 2px; width: 100px; height: 20px; margin-bottom: 5px;">n̄o6Ē</div> |
|--|--|

4.4.7.5 Sending Delay Time



Sets the delay with which the sensor responds to a serial command sent by the host device.

Use this function if "Connection Mode" is set to "RS485 Multiple" (default setting).

Setting	Function	Digital display
0	No delay time	0
0.1	Delay time of 0.1ms	01
0.2	Delay time of 0.2ms	02
0.5	Delay time of 0.5ms	05
1	Delay time of 1ms	1
2	Delay time of 2ms	2
5	Delay time of 5ms	5
10	Delay time of 10ms	10
20	Delay time of 20ms	20
50	Delay time of 50ms	50
100	Delay time of 100ms	100
200	Delay time of 200ms	200
500	Delay time of 500ms	500
1000	Delay time of 1000ms	1000



Procedure

1. 2s
2. 6x
- 3.
4. 4x

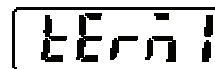
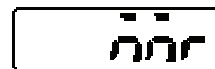

- 5.  
- 6.  or  to change the setting 
- 7.  to confirm 

4.4.8 System Functions



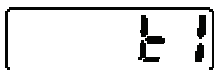

This function menu contains system functions for timing and eco mode, laser control, and version information.

4.4.8.1 Timing Mode













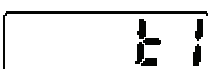

Determines how the sensor head works when the timing input is ON.

For information on how the timing signal influences the system behavior, refer to the time diagrams (see page 33). The bold table entry indicates the default setting.

Setting	Function	Digital display
Hold	When the timing input is ON, the last measurement value is held until the timing input goes OFF.	
One Shot	A rising edge at the timing input triggers one measurement. The measured value will be held until the timing or zero-set signal is input.	



◆ Procedure

- 1.  2s 
- 2.  7x 
- 3.  
- 4.  
- 5.  or  to change the setting 
- 6.  

4.4.8.2 Laser Control



Switches the laser emission ON and OFF.

Use this function to stop laser emission when the system is not needed for measuring. The bold table entry indicates the default setting.

Setting	Function	Digital display
Emission	Laser emission is ON.	
Stop	Laser emission is OFF.	



◆ NOTE

Note that the status of the output data becomes undefined (see page 31) when you switch the laser emission from OFF to ON.





◆ Procedure

1. 2s
2. 7x
- 3.
- 4.
- 5.
6. or to change the setting
- 7.

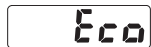
4.4.8.3 Eco Mode

 Turns OFF the LED indicators on the control panel to save energy while the system is in RUN mode.

The bold table entry indicates the default setting.

Setting	Function	Digital display
Eco-OFF	No Eco mode has been activated.	
Eco-ON	Only the LEDs forming the digital display will be turned OFF.	
Eco-FULL	All the LEDs will be turned OFF.	

















NOTE

- The LEDs are always lit when the system is in setting mode.
- When the system is set to "Eco-ON" and the LEDs are turned off, the display will come to life again when you press a button. The LEDs will be turned OFF again if no buttons are pressed for 20 seconds.











Procedure

-  2s 
-  7x 
-  
-  2x 
-  
-  or  to change the setting 
-  

4.4.8.4 View Version

 Displays the version of the firmware.

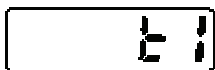
 **Procedure**

- | | |
|--|--|
| <ol style="list-style-type: none"> 1.  2s 2.  7x 3.  4.  3x 5.  to display the current firmware version | 



 |
|--|--|

4.4.9 Buffering Functions (Multifunction Type Only)

Buffering is a function to accumulate measurement data in the built-in memory of the sensor so that you can load the data to an external control device such as a PC.

A maximum of 3,000 measurement data items can be accumulated. The accumulated data can be loaded by using the software HL-G1SMI or a serial command (RS422 or RS485)

The software HL-G1SMI (sold separately) helps you to verify the measurement data because it converts the data into CSV format. CSV files can be displayed graphically, saved, replayed, and opened in Microsoft Excel.

 **NOTE**

- Buffering settings cannot be made via the control panel. All settings need to be made by serial commands.
- To execute buffering, you need to write a program for RS422/485 or use the software HL-G1SMI.
- While measurement data is being buffered, it is not possible to change the buffering settings. In order to change the buffering settings, you need to send the stop command.

Data buffering

The data buffering works as shown below.

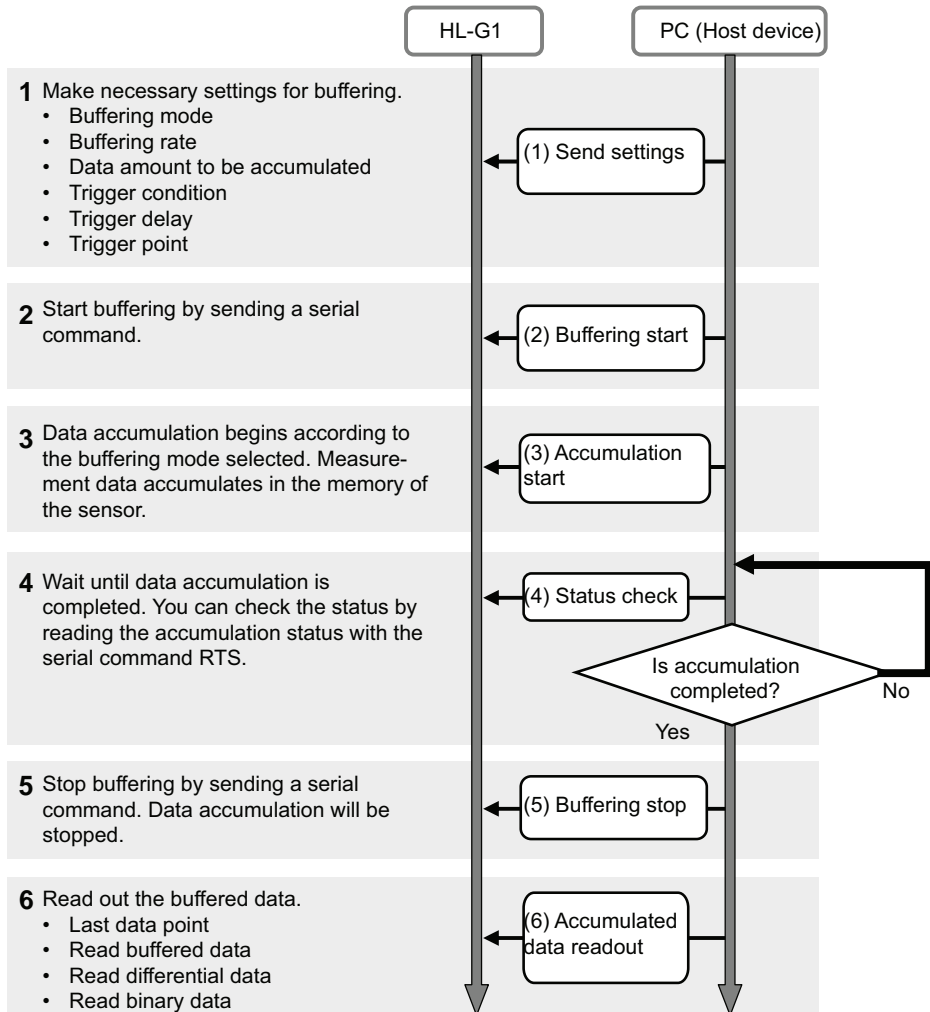

Buffering mode

There are two modes for buffering, "Continuous" and "Trigger". The default setting is "Continuous".

With "**Continuous**", buffering the measurement data begins when the sensor head receives the start command and continues until either the amount of data to accumulate has been reached or the sensor receives a stop command.

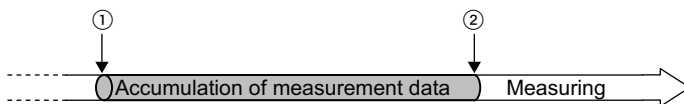

①	Data buffering starts
②	The amount of data to be accumulated has been reached or the sensor has received a stop command.

With **"Trigger"**, the trigger generation will be on stand-by when buffering the measurement data starts. The measurement data before and after the trigger point occurs will be accumulated in the built-in memory of the sensor. Buffering continues until either the amount of data to accumulate has been reached or the sensor receives a stop command.

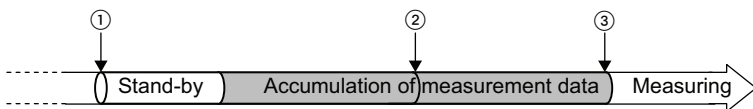

①	Data buffering starts
②	Trigger is generated (trigger point)
③	The amount of data to be accumulated has been reached or the sensor has received a stop command.

Buffering rate

When measurement data is to be accumulated over a long time period, it makes sense to reduce the amount of data by setting a buffering rate. The buffering rate is applied to the sampling cycles.

Select from 1 (all measurement data), 1/2, 1/4, etc. to 1/65535. The buffering rate is set to "1/10" by default. If there is not much deviation in the measurement data per sampling cycle, select a higher value for this function so that the memory does not fill up too quickly.



◆ EXAMPLE

If you select 1/4 as the buffering rate, measurement data will be accumulated once every four sampling cycles.

Data amount

This function sets the amount of measurement data to be accumulated. Select an amount from 1 to 3000. The default value is 3000. Note that if "Buffering Mode" is set to "Trigger", data accumulation will not start if "Trigger Point" is set to a value larger than "Data amount".

Trigger point

This function sets a data point as the trigger for buffering (only valid if "Buffering Mode" is set to "Trigger"). The setting range for this function is between 1 and <accumulated amount of data>. The default value is 300.



◆ NOTE

- **Data accumulation will not start if "Trigger Point" is set to a value larger than "Data Amount".**
- **You can set a trigger delay, if you want a time delay between the generation of the trigger point and the loading of the measurement data.**

Trigger delay

This function delays the loading of measurement data after the trigger detection when "Buffering Mode" is set to "Trigger". Set the number of sampling times for the trigger delay. The

setting range is 0 to 65535 (default setting: 0). The status during the trigger delay time is "Accumulating."

Trigger condition

This function specifies under which condition the trigger is generated when "Buffering Mode" is set to "Trigger". There are 5 conditions available. The default setting is "When TM input turns ON".

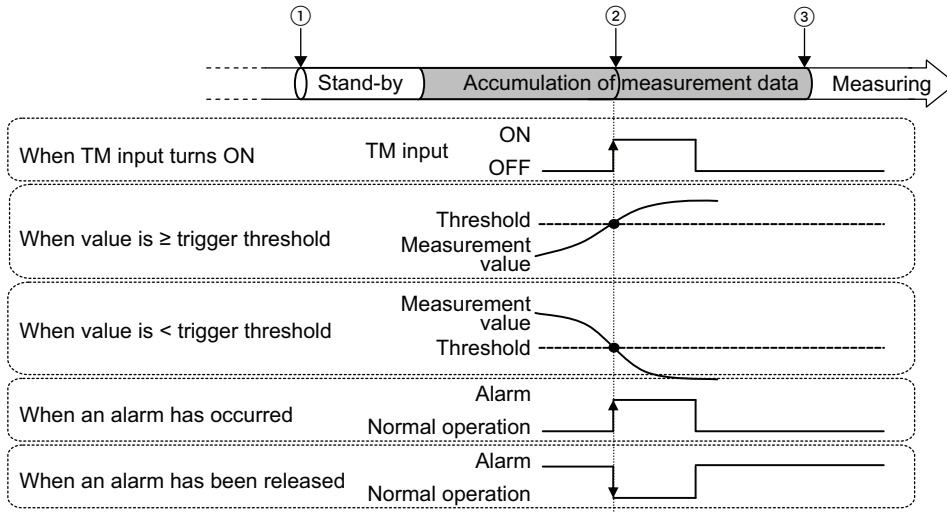

①	Data buffering starts
②	Trigger is generated (trigger point)
③	The amount of data to be accumulated has been reached or the sensor has received a stop command.



◆ NOTE

- If you select "When an alarm has occurred" as the condition, note that the setting for "Alarm Delay" (see page 70) also becomes effective.
- Normally, the measurement value is kept on hold when the timing input is ON. However, if "Buffering mode is set to "Trigger" and "Trigger Condition" is set to "When TM input turns ON", the measurement value will NOT be kept on hold at the moment the timing input is ON while the system is in buffering operation.

Buffering operation

This function accumulates data. You need to make all buffering settings before sending the command to start buffering.

Reading the buffering status

Use this function for checking the accumulation status before reading out the accumulated data.

Status	Details
Non-buffering	Buffering is not executed at all after the power supply has been turned on or after initialization or buffering is stopped while waiting for the trigger after buffering has started.
Waiting for trigger	Buffering has started and the sensor is waiting for the trigger.
Accumulating	Buffering has started and measurement data is being accumulated or the trigger has been generated and measurement data is being accumulated.
Accumulation completed	The accumulation amount has reached the value set in "Data amount" or buffering has been stopped.

Last data point

The last data point provides information about the accumulation status during buffering.



◆ NOTE

The "Final Data Point" will be set to "0" when the "Status Readout" is set to "Non-buffering".

Binary readout of buffering data

The measurement data accumulated in the sensor head memory can be read out in a range from 1 to the last data point.



◆ NOTE

To read out the buffering data, stop buffering and check the "Last Data Point." The accumulated data can be read out only if

- the result of "Status Readout" is "Accumulation Completed", and
- the last data point is not 0.

4.4.10 Functions Controlled by the MI Input

Some of the function settings available via the control panel can also be changed with the MI input.

t	Function
30ms	Zero set ON (see page 85)
80ms	Reset (see page 85)
130ms	Select memory M0 (see page 50)
180ms	Select memory M1
230ms	Select memory M2
280ms	Select memory M3
330ms	Teach displacement judgment threshold a
380ms	Teach displacement judgment threshold b
430ms	Zero set OFF (Cancel) (see page 59)

t	Function
480ms	Save (see page 46)
530ms	Laser ON (see page 78)
580ms	Laser OFF (see page 78)

4.4.10.1 Zero Set

By inputting the MI signal for 30ms you set the current measurement value and the digital display to zero.



There are two other ways to perform a zero set:

- In run mode, press  and  together
- Send the serial command RZS

For information on how the zero-set signal influences the system behavior, refer to the time diagrams (see page 33).

4.4.10.2 Reset

By inputting the MI signal for 80ms you reset all measurement values and turn the judgment outputs off.



◆ NOTE

- **When the reset signal is input, the output data status becomes undefined (see page 31). The analog output will either be the initial value of 11.000 [V] or 21.6 [mA] or a predefined fixed value, depending on the setting of "Analog Output Selection" (see page 66).**
- **When you perform the reset by sending the serial command RRS, the memory will be cleared.**

There are two other ways to perform a reset:

- In run mode, press  and  together
- Send the serial command RRS

For information on how the reset signal influences the system behavior, refer to the time diagrams (see page 33).

Chapter 5

Serial Communication via RS422/485

5.1 Communication Specifications

The communication specifications of the sensor are listed in the table.

Item	Description	
Interface	RS422	RS485
Communication method	Full duplex	Half-duplex
Baud rate	9,600bps, 19,200bps, 38,400bps, 115,200bps, 230,400bps, 460,800bps, 921,600bps (default setting = 38,400bps)	
Synchronous method	Start stop asynchronous system	
Communication format	Data length: 8 bits Parity: None Stop bit: 1 bit End code: CR (0DH) BCC: Yes (disable by entering "****" (2AH, 2AH))	



◆ NOTE

- To establish communication via RS422/485, both the sensor and the host device must use the same communication settings.
- When you change the baud rate in the sensor head, you need to restart the sensor to make sure the new baud rate is used.

5.1.1 Pin Arrangement

Pin No.	Lead wire color		Signal name	Signal direction	Description
11	Twisted-pair wire	Green (before Dec 2010: Black)	+SD	Sensor output → External device input	Transmitted data signal (+). Usually connected to +RD (+RxD) of external device.
12		Sky blue (before Dec 2010: White)	-SD		Transmitted data signal (-). Usually connected to -RD (-RxD) of external device.
13	Twisted-pair wire	Orange (wire color has not changed)	+RD	Sensor input ← External device output	Received data signal (+). Usually connected to +SD (+TxD) of external device.
14		Yellow (before Dec 2010: White)	-RD		Received data signal (-). Usually connected to -SD (-TxD) of external device.
15			SG	Sensor ↔ External device	Signal ground. Usually connected to SG (SG) of external device.



◆ NOTE

The sensor heads produced before December 2010 use different wire colors. Please check the wire colors on the sensor head you are using.

5.1.2 Connection Example

Please refer to the examples below for information on how to connect the sensor to an external device.



◆ NOTE

- The cables used for sending and receiving data should be twisted-pair cables.
- The shield is connected to the 0V side of the power supply line inside the sensor.

5.1.2.1 1:1 Communication via RS422

Set "Connection Mode" to "RS422 Handshake", "RS422 Timing", or "RS422 Continuous" (see page 74) depending on your requirements. Set the sensor number to 01 (see page 72).

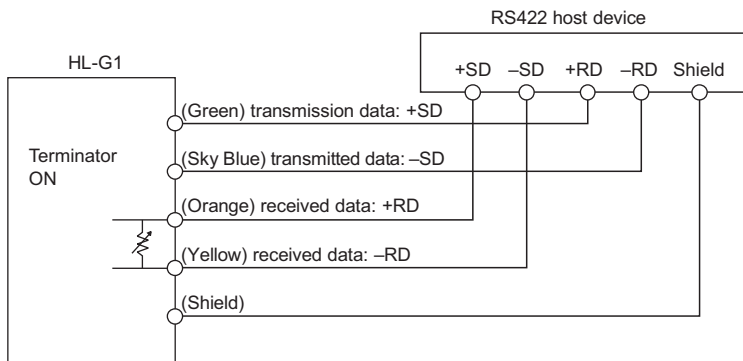

5.1.2.2 1:n Communication via RS485

Set "Connection Mode" to "RS485 Multiple". Set a unique number for each connecting sensor so that there are no duplicate numbers (see page 72).

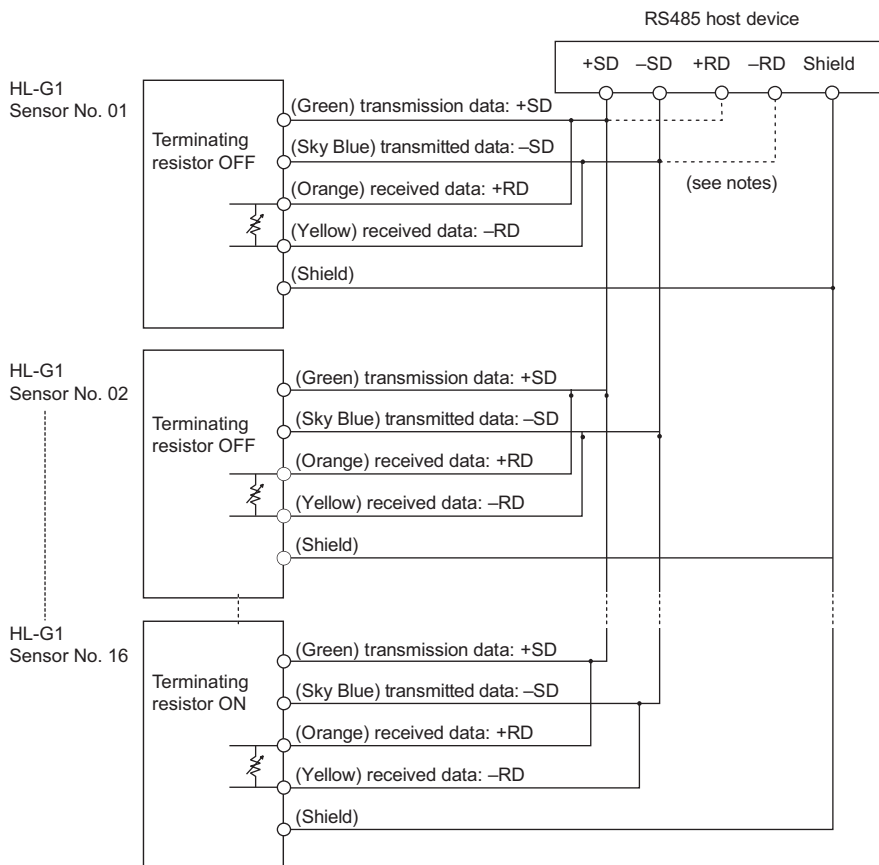

◆ NOTE

- The sensor has a built-in terminating resistor. You need to select "R3" for the last sensor and set all other sensors to OFF (see page 71).
- Make sure to wire and connect the external device according to its specifications.

5.2 Serial Commands

An external device such as a PLC can use serial communication to request different types of data from the sensor or send new parameter settings or setting values to the sensor. All commands used in serial communication are structured in a specific way. If the PLC sends a command with a different structure, the sensor will return an error code (see page 102).

The communication sequence works as follows:

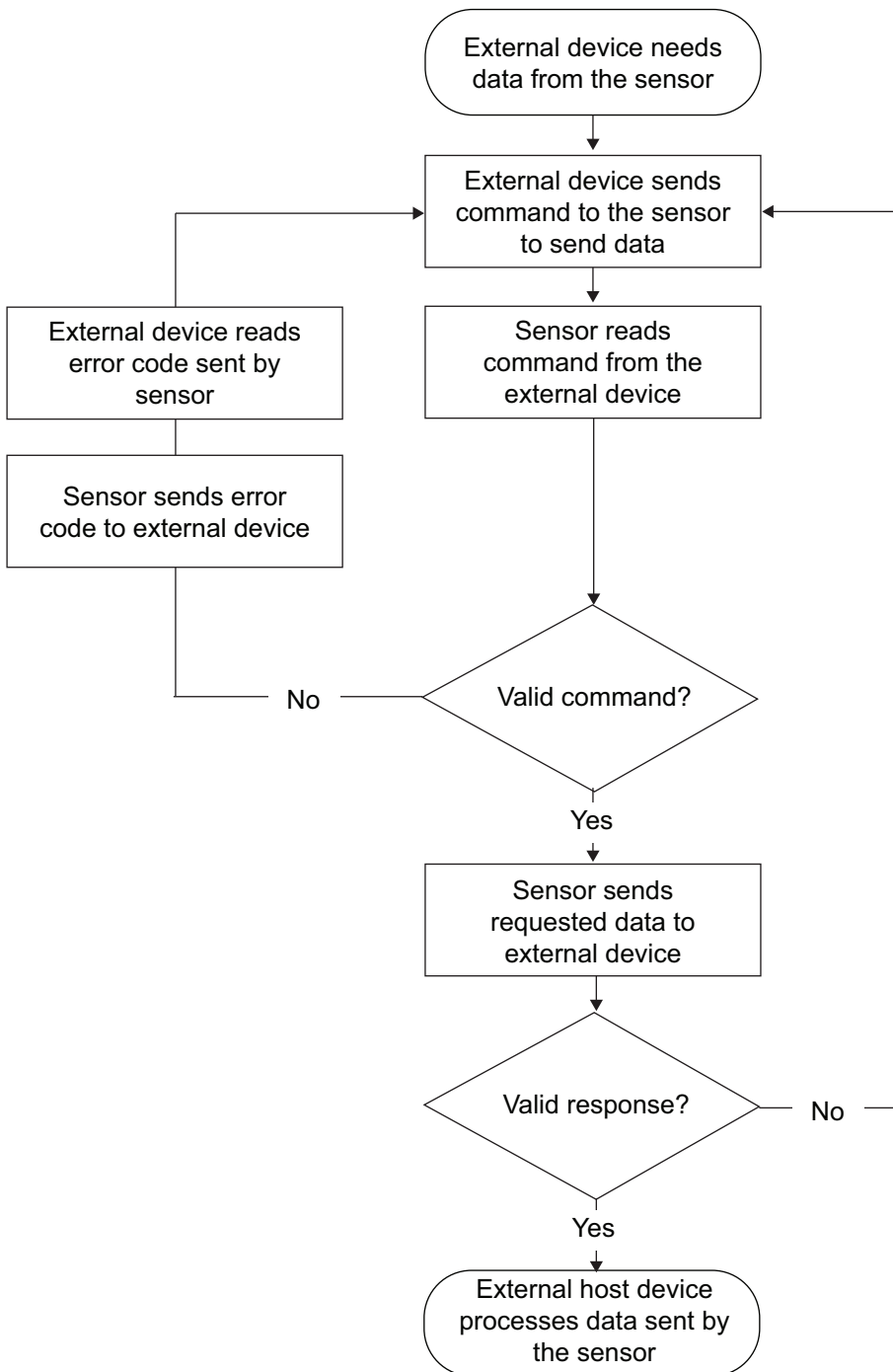

5.2.1 Read and Write Settings or Numerical Values

The following read and write commands can be used by a PLC or other external device to read or write settings or numerical values from or to the sensor.



◆ NOTE

- **Format 1 and 2 only differ in the number of digits transmitted. Format 1 uses 5 characters for the numerical value, format 2 uses 7 characters. Both formats use 1 character for the +/- sign in front of the numerical value.**
- **Zeroes are not suppressed.**
- **Decimal points are omitted.**

5.2.1.1 Read Command (Format 1 and 2)

Request command from the external device

Use this command to read data from the sensor.

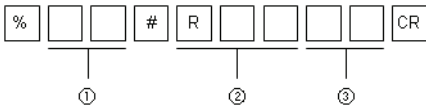

①	Number of the sensor to which the request is sent
②	Command sent to the sensor. Select the appropriate command from the command tables (see page 104).
③	BCC

Normal response (format 1)

If the command can be interpreted correctly by the sensor, this is the normal response. If the sensor cannot interpret the command correctly, the sensor returns an error code (see page 102).

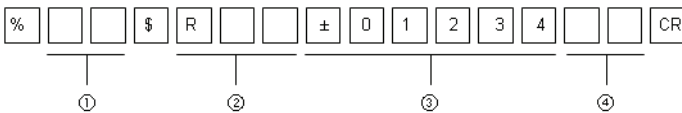

①	Sensor number
②	Command the sensor has received.
③	Block with the requested data.
④	BCC



◆ EXAMPLE

Use this command to read the sampling cycle currently selected for sensor 1.

```
% 0 1 # R S P * * CR
```

A normal response from the sensor would be as follows:

```
% 0 1 $ R S P + 0 0 0 0 1 * * CR
```

Normal response (format 2)

If the command can be interpreted correctly by the sensor, this is the normal response. If the sensor cannot interpret the command correctly, the sensor returns an error code (see page 102).

```
% [ ] [ ] $ R [ ] [ ] ± 9 5 0 0 0 0 0 [ ] [ ] CR
```

①
②
③
④

①	Sensor number
②	Command the sensor has received.
③	Block with the requested data. 1 character for +/- and 7 characters for integers (zeros are not suppressed).
④	BCC



◆ EXAMPLE

Use this command to read the current measurement value for sensor 3.

```
% 0 3 # R M D * * CR
```

A normal response from the sensor would be as follows:

```
% 0 3 $ R M D - 1 2 3 4 5 6 * * CR
```

①

①	Measured value = -12.3456 [mm]
---	--------------------------------

Note that the decimal point is omitted.

5.2.1.2 Write Command (Format 1)

Request command from the external device

Use this command to write 5-digit values for function settings in the sensor.

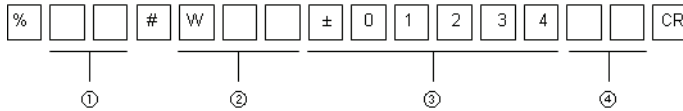

①	Number of the sensor to which the request is sent
②	Command sent to the sensor. Select the appropriate command from the command tables (see page 104).
③	Block of data to be written to the sensor. 1 character for +/- and 5 characters for integers (zeros are not suppressed).
④	BCC

Normal response from the sensor

If the command can be interpreted correctly by the sensor, this is the normal response. If the sensor cannot interpret the command correctly, the sensor returns an error code (see page 102).

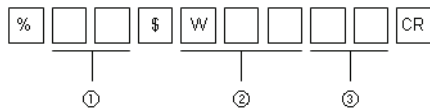

①	Sensor number
②	Command the sensor has received.
③	BCC



◆ EXAMPLE

Use this command to set the average function to 256 times for sensor 2.



A normal response from the sensor would be as follows:



5.2.1.3 Write Command (Format 2)

Request command from the external device

Use this command to write 7-digit values for function settings in the sensor.

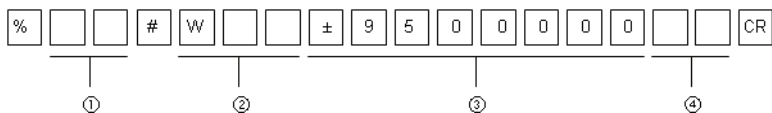

①	Number of the sensor to which the request is sent
②	Command sent to the sensor. Select the appropriate command from the command tables (see page 104).
③	Block of data to be written to the sensor. 1 character for +/- and 7 characters for integers (zeros are not suppressed).
④	BCC

Normal response from the sensor

If the command can be interpreted correctly by the sensor, this is the normal response. If the sensor cannot interpret the command correctly, the sensor returns an error code (see page 102).

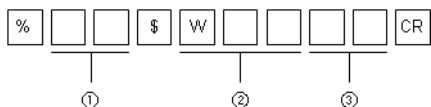

①	Sensor number
②	Command the sensor has received.
③	BCC



◆ EXAMPLE

Use this command to set the displacement judgment threshold to +5.5 [mm]average for sensor 4.



A normal response from the sensor would be as follows:



5.2.2 Read Status of the Sensor Outputs (Format 3)

Request command from the external device

Use this command to read the following information from a sensor:

- Current measurement value
- Received light intensity
- Status of the outputs OUT1-3 and ALARM

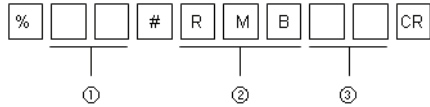

①	Number of the sensor to which the request is sent
②	Command to read the status of all outputs
③	BCC

Normal response from the sensor

If the command can be interpreted correctly by the sensor, this is the normal response. If the sensor cannot interpret the command correctly, the sensor returns an error code (see page 102).

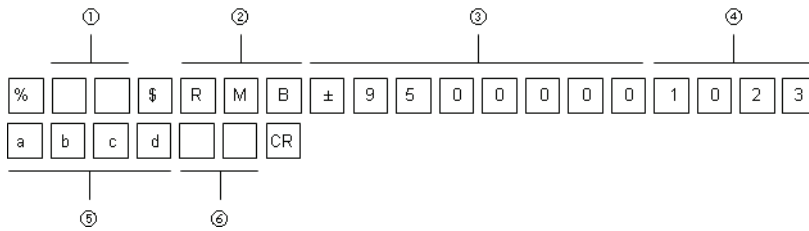

①	Sensor number
②	Command the sensor has received.
③	Measured value. 1 character for +/- and 7 characters for integers (zeros are not suppressed).
④	Light intensity. 4 characters for integers (zeros are not suppressed).
⑤	Status of the outputs (0 = OFF, 1 = ON). <ul style="list-style-type: none"> • a: OUT1 • b: OUT2 • c: OUT3 • d: ALARM
⑥	BCC



◆ EXAMPLE

Use this command to read all outputs from sensor 1.



A normal response from the sensor would be as follows:

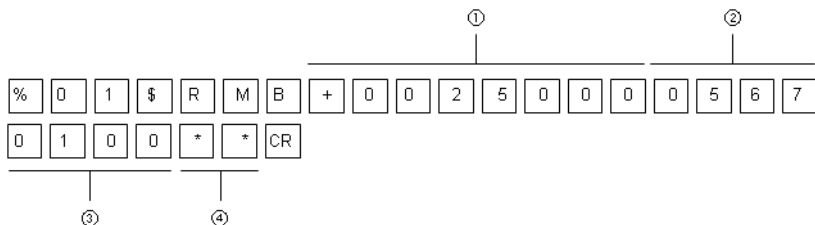

①	Measured value ==+2.500 [mm]
②	Light intensity = 567
③	Status of the outputs (0 = OFF, 1 = ON). <ul style="list-style-type: none"> • OUT1 = OFF • OUT2 = ON • OUT3 = OFF • ALARM = OFF
④	BCC

5.2.3 Read Buffered Data from the Sensor Memory (Formats 4 – 6)

There are three ways to read the buffered data from the sensor memory:

- Read buffered data from start to end point (see page 98)
- Read differential data from start to end point (see page 99)
- Read buffered data from start to end point in binary format (see page 100)

5.2.3.1 Read Buffered Data from Start to End Point (Format 4)

Request command from the external device

Use this command to read a range of buffered data from the sensor memory. You need to specify the data range by sending the start and end point of the buffered data to be read.

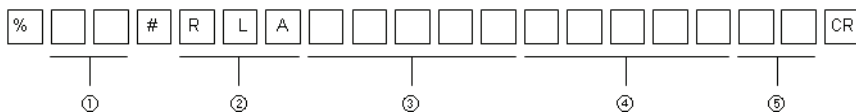

①	Number of the sensor to which the request is sent
②	Command to read the buffered data from the sensor memory
③	Start point (0001 – 3000)
④	End point (0001 – 3000)
⑤	BCC

Normal response from the sensor

If the command can be interpreted correctly by the sensor, this is the normal response. If the sensor cannot interpret the command correctly, the sensor returns an error code (see page 102).

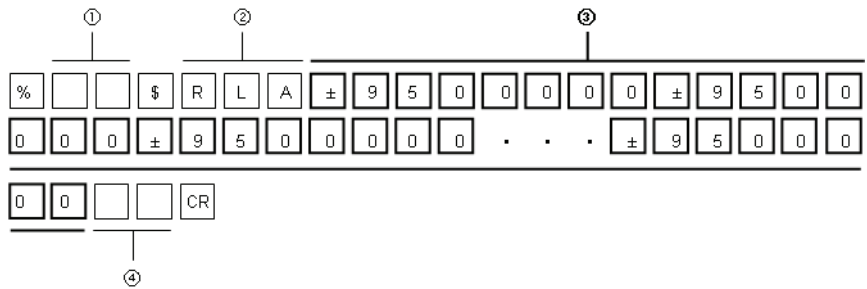

①	Sensor number
②	Command the sensor has received.
③	Buffered data from start to end point
④	BCC

5.2.3.2 Read Differential Data (Format 5)

Request command from the external device

Use this command to read the buffered data in signed differential format from the start to the end point. The sensor will send the measurement value from the start point and then only the difference to the next measurement value with a + or - sign.

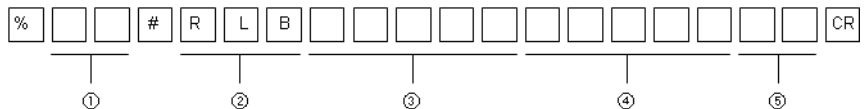

①	Number of the sensor to which the request is sent
②	Command to read the buffered data from the sensor memory
③	Start point (0001 – 3000)
④	End point (0001 – 3000)
⑤	BCC

Normal response from the sensor

If the command can be interpreted correctly by the sensor, this is the normal response. If the sensor cannot interpret the command correctly, the sensor returns an error code (see page 102).

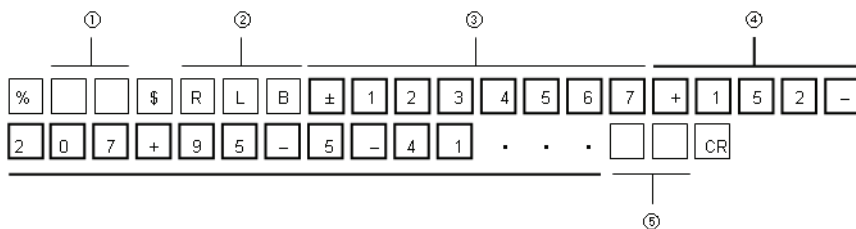

①	Sensor number
②	Command the sensor has received.
③	Measured value at start point. 1 character for +/- and 7 characters for integers (zeros are not suppressed).
④	Differential data between one measurement value and the next until the end point is reached
⑤	BCC



◆ EXAMPLE

The output of differential data as shown above would be transmitted if the sensor memory contained the following buffered measurement values:

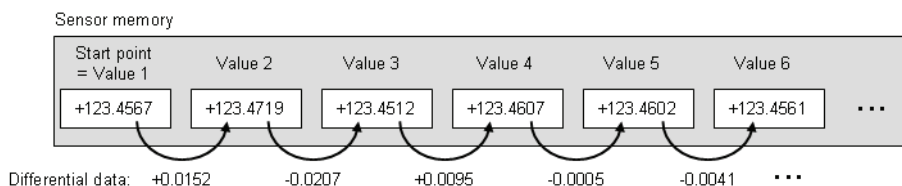

5.2.3.3 Read Buffered Data in Binary Format (Format 6)

Request command from the external device

Use this command to read the buffered data in binary format. Every measurement value in the sensor memory will be converted to binary format. The binary data is in 4 bytes beginning with the lowest byte (little-endian).

Measurement value	Response from sensor	Binary	Decimal
Start point	87 06 12 00	0x0012D687	1234567
Second point (start point + 1)	1F 07 12 00	0x0012D71F	1234719

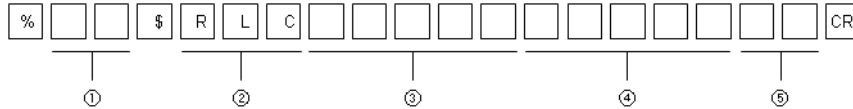

①	Number of the sensor to which the request is sent
②	Command to read the buffered data from the sensor memory
③	Start point (0001 – 3000)
④	End point (0001 – 3000)
⑤	BCC

Normal response from the sensor

If the command can be interpreted correctly by the sensor, this is the normal response. If the sensor cannot interpret the command correctly, the sensor returns an error code (see page 102).

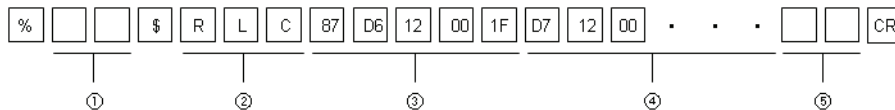

①	Sensor number
②	Command the sensor has received.
③	Binary data for start point
④	Binary data for second point (start point + 1)
⑤	BCC

5.2.4 Data Output from the Sensor (Format 7)

The sensor uses a special format for outputting the measurement data to the PLC when the connection mode is set to "RS422 Timing" or "RS422 Continuous" (see page 74).

- With "RS422 Timing", the sensor outputs measurement data **once** when the TM (timing) input is turned ON (see page 27).
- With "RS422 Continuous", the sensor **starts and continues** to output measurement data as soon as this mode is activated.

Format of the sensor output

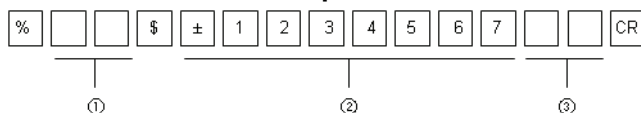

①	Sensor number
②	Data block. 1 character for +/- and 7 characters for integers (zeros are not suppressed).
③	BCC

5.2.5 Error Response and Error Codes

If the sensor cannot interpret the command it has received, for example because the command did not use the correct structure or was garbled during transmission, the sensor will send an error response containing an error code. The error response will always have the same format, regardless of the command format sent to the sensor and regardless of the communication protocol (MEWTOCOL or the general serial protocol).

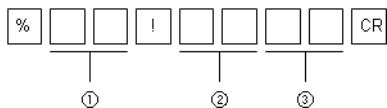

The sensor can output the following error codes:

Error code	Error type	Description
01	Command error	The command is undefined.
02	Address error	<ul style="list-style-type: none"> The start address is larger than the end address or the address is larger than 999999 when the RDD or WDD command is executed. The address length has not reached the prescribed length when the RDD or WDD command is executed.
03	Data error	<ul style="list-style-type: none"> The data length does not correspond to the command. The data length has not reached the prescribed length.
04	BCC error	The BCC check showed a difference between data transmission and data reception.
11	Communication error	<ul style="list-style-type: none"> A parity error has occurred during data reception. A framing error has occurred during data reception. An overrun error has occurred during data reception.
21	Control flow error	The system is in setting mode.
22	Execution error	Calibration or analog scaling cannot be executed.
31	Buffering condition error 1	An attempt was made to change a buffering setting without stopping buffering first.
32	Buffering condition error 2	An attempt was made to change a buffering setting to an invalid setting.
33	Buffering condition error 3	Data was read after buffering operation started. Data was read while the system was not in the accumulation completed status. Data in excess of the final data point was specified and read.



◆ NOTE

If the external device receives an abnormal response from the sensor, check the following:

- Has the external device sent a valid command?
- Is the sensor's wiring correct?
- Is there a noise source near the sensor or the PLC?

It may also help to turn the sensor head or external device OFF and ON.

5.2.6 BCC Creation

BCC is a horizontal parity check code used to improve the reliability of data communication. The sensor calculates the exclusive OR from the header (%) to the end character of the data. The resulting 8-bit data exclusive OR is converted to a 2-character ASCII code. The sensor then compares the 2-character ASCII code with the transmitted BCC value. If the BCC at the time of transmission differs from that after reception, it means that an error has occurred while the message was being transmitted. In that case, the sensor returns an error response with error code 04 (see page 102).

If you do not want to execute BCC calculation, send ** (2AH, 2AH) as the BCC. If you send data without BCC, the BCC in the response data will be ** (2AH, 2AH) as well.



①	2-character BCC
---	-----------------

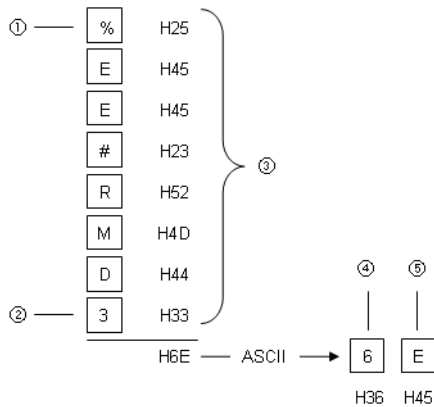

①	Header
②	End character
③	Exclusive OR (XOR) is calculated with the data
④	BCC higher bit
⑤	BCC lower bit

5.2.7 Command List

The following tables list the serial communication commands available.



◆ NOTE

- The data consists of a 5- or 7-digit decimal figure (zeroes are not suppressed).
- The "Command" column is split in two: On the left side, you find the READ commands (starting with the letter "R"), on the right side, you find the WRITE commands (starting with the letter "W").

5.2.7.1 Basic Settings

Function name	Command		Data	Setting [unit]	Format
Sampling cycle	RSP	WSP	+00000	200 [μs]	1
			+00001	500 [μs]	
			+00002	1 [ms]	
			+00003	2 [ms]	
Shutter time	RFB	WFB	+00000 – +00031	+00000: Auto +00001 – +00031: Fixed	1

5.2.7.2 Data Processing Settings

Function name	Command		Data	Setting [unit]	Format
Average function	RAV	WAV	+00000	1 [value]	1
			+00001	4 [values]	
			+00002	16 [values]	
			+00003	64 [values]	
			+00004	256 [values]	
			+00005	1024 [values]	
Analysis mode	RHM	WHM	+00000	Normal measurement	1
			+00001	Peak measurement	
			+00002	Valley measurement	
			+00003	Peak-to-peak measurement	
Zero set	RZS	WZS	+00000	OFF	1
			+00001	ON	
Value used as zero setting	RZV	—	-9500000 – +9500000	-950.0000 – +950.0000 [mm]	2
Span	RMK	WMK	+01000 – +99999	+0.1000 – +9.9999	1
Offset	RML	WML	-9500000 – +9500000	-950.0000 – +950.0000 [mm]	2

5.2.7.3 Output Settings

Function name		Command		Data	Setting [unit]	Format
Judgment output selection		ROD	WOD	+00000	Logic	1
				+00001	Independent	
				+00002	2-state	
				+00003	3-state	
Displacement Judgment	Threshold a	RHA	WHA	-9500000 – +9500000	-950.0000 – +950.0000 [mm]	2
	Threshold b	RHB	WHB			
	Hysteresis	RHH	WHH	+0000000 – +9500000	+000.0000 – +950.0000[mm]	
Judgment output OFF delay		ROF	WOF	+00000	OFF	1
				+00001	2 [ms]	
				+00002	4 [ms]	
				+00003	10 [ms]	
				+00004	20 [ms]	
				+00005	40 [ms]	
				+00006	100 [ms]	
				+00007	Hold	
Measurement value display on panel		RDS	WDS	+00000	All digits are displayed	
				+00001	The rightmost digit is OFF.	
				+00002	The two rightmost digits are OFF.	

5.2.7.4 Analog Settings

Function name		Command		Data	Setting [unit]	Format
Analog output selection		RAS	WAS	+00000	Output current	1
				+00001	Output voltage	
Analog scaling (measurement value)	A	RAL	WAL	-9500000 – +9500000	-950.0000 – +950.0000 [mm]	2
	B	RAH	WAH			
Analog scaling (voltage)	a	RVL	WVL	+00000 – +10000	+00.000 – +10.000 [V]	1
	b	RVH	WVH	+00000 – +10000	+00.000 – +10.000 [V]	
Analog scaling (current)	a	RIL	WIL	+04000 – +20000	+04.000 – +20.000 [mA]	1
	b	RIH	WIH	+04000 – +20000	+04.000 – +20.000 [mA]	

5.2.7.5 Alarm Settings

Function name	Command		Data	Setting [unit]	Format
Analog output at alarm	RAA	WAA	+00000	Hold	1
			+00001	Fixed value	
Digital output at alarm	RAD	WAD	+00000	Hold	
			+00001	Fixed value	
Alarm delay	RHC	WHC	+00000 – +65535	+00000 – +65535 [times] (0: OFF, 65535: Previous normal value kept on hold)	1

5.2.7.6 System Settings

Function name	Command		Data	Setting [unit]	Format
Memory selection	RMC	WMC	+00000	M0	1
			+00001	M1	
			+00002	M2	
			+00003	M3	
Timing mode	RTM	WTM	+00000	Hold	
			+00001	One shot	
Laser control	RLR	WLR	+00000	Stop	
			+00001	Emission	
Eco mode	RDP	WDP	+00000	Eco-OFF	
			+00001	Eco-ON	
			+00002	Eco-FULL	
Initialize	—	WIN	+00000	Initialize without saving the settings	
	—	WWR	+00001	Initialize and save the settings	
Timing	RTI	WTI	+00000	OFF	
			+00001	ON	
Reset	RRS	WRS	+00000	OFF	
			+00001	ON	
Display hold	RHD	WHD	+00000	OFF	
			+00001	ON	

5.2.7.7 Read Commands

Function name	Command		Data	Setting [unit]	Format
Read measurement value	RMD	—	-9500000 – +9500000	-950.0000 – +950.0000[mm]	2
Read received light intensity	RID	—	+00000 – +04095	+00000 – +04095	1
Alarm status	ROA	—	+00000	Alarm OFF	
			+00001	Alarm ON	
Read OUT1	RZA	—	+00000	OUT1 OFF	
			+00001	OUT1 ON	
Read OUT2	RZB	—	+00000	OUT2 OFF	
			+00001	OUT2 ON	
Read OUT3	RZC	—	+00000	OUT3 OFF	
			+00001	OUT3 ON	
Read all outputs	RMB	—	—	Measured value, received light intensity, OUT1, OUT2, OUT3, ALARM	3

5.2.7.8 Buffering Commands

Function name	Command		Data	Setting [unit]	Format
Buffering mode	RBD	WBD	+00000	Continuous	1
			+00001	Trigger	
Buffering rate	RBR	WBR	+00001 – +65535	+00001 – +65535	1
Data amount	RBC	WBC	+00001 – +03000	+00001 – +03000	
Trigger point	RTP	WTP	+00001 – +03000	+00001 – +<accumulated amount>	
Trigger delay	RTL	WTL	+00001 – +65535	+00001 – +65535	
Trigger condition	RTR	WTR	+00000	When TM input turns ON	
			+00001	When value is ≥ trigger threshold	
			+00002	When value is < trigger threshold	
			+00003	When an alarm has occurred	
			+00004	When an alarm has been released	
Trigger threshold	RBL	WBL	-9500000 – +9500000	-950.0000 – +950.0000 [mm]	2
Buffering operation	RBS	WBS	+00000	Stop	1
			+00001	Start	
Read buffering status	RTS	—	+00000	Non-buffering	
			+00001	Wait for trigger	
			+00002	Accumulating	
			+00003	Accumulation completed	
Last data point	RLD	—	+00001 – +03000	+00001 – accumulated amount	1

Function name	Command		Data	Setting [unit]	Format
Read buffered data	RLA	—	—	5-character head point + 5-character end point Specify the head data point and the end data point.	4
Read differential data	RLB	—	—	5-character head point + 5-character end point Specify the head data point and the end data point.	5
Read binary data	RLC	—	—	5-character head point + 5-character end point Specify the head data point and the end data point.	6

Chapter 6

Address List for MEWTOCOL Communication

6.1 Introduction

If you connect the sensor to a Panasonic PLC (FP series) or programmable display (GT series), you can use the data registers (DT registers) for communication. In addition to the DT registers listed here, the data area DT01900–DT01949 is an open area and can be used as desired.



◆ NOTE

- The sensor may react in an unexpected way when it receives an unknown command. If the sensor behaves in an unexpected way, turn the power OFF and ON again and initialize all settings.
- We recommend following these communication rules:
 - Do not write to or read from an address not listed in this chapter.
 - Do not write to an address that is read-only (marked with —)
 - Do not send values outside the specified data range.

6.1.1 MEWTOCOL Command Formats

The following read and write commands can be used by a PLC or other external device to read or write settings or numerical values from or to the sensor.

6.1.1.1 Read Command

Request command from the external device (PLC or GT panel)

Use this command format to read data from the sensor.

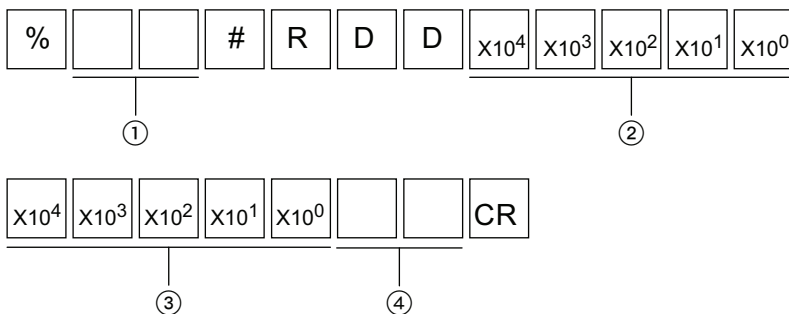

①	Number of the sensor to which the request is sent
②	Start address (5 characters)
③	Last address (5 characters)
④	BCC

Normal response from the sensor

If the command can be interpreted correctly by the sensor, this is the normal response. If the sensor cannot interpret the command correctly, the sensor returns an error code (see page 102).

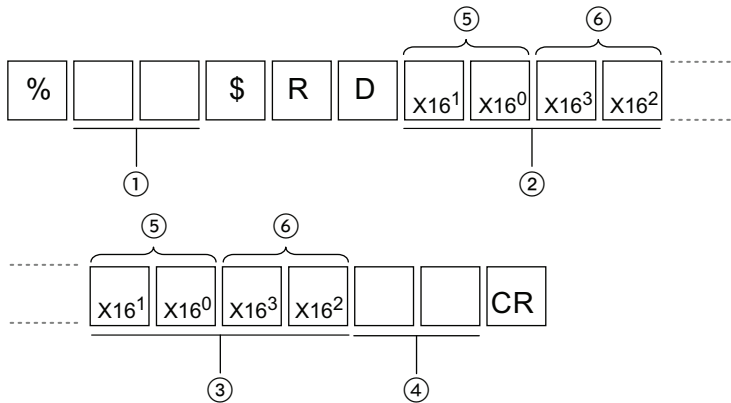

①	Sensor number
②	Start address (5 characters)
③	Last address (5 characters)
④	BCC
⑤	Lower word
⑥	Higher word

6.1.1.2 Write Command

Request command from the external device

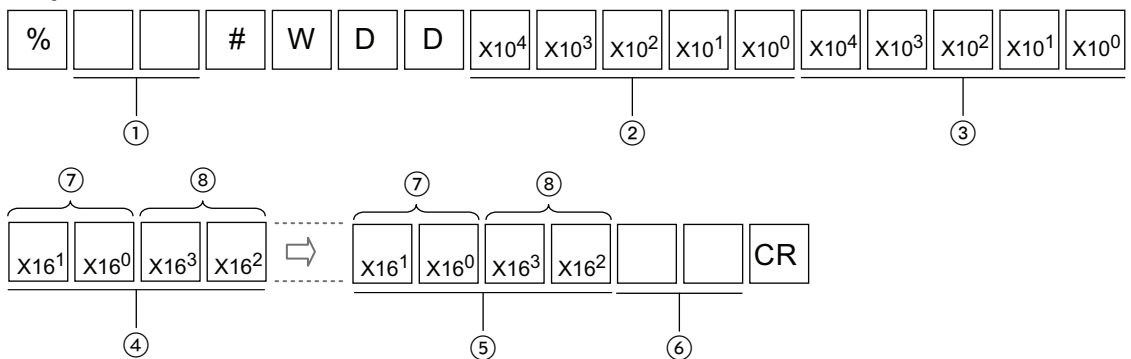

①	Sensor number
②	Start address (5 characters)
③	Last address (5 characters)
④	First block of data to be written to the sensor (4 characters)
⑤	Last block of data to be written to the sensor (4 characters)

⑥	BCC
⑦	Lower word
⑧	Higher word

Normal response from the sensor

If the command can be interpreted correctly by the sensor, this is the normal response. If the sensor cannot interpret the command correctly, the sensor returns an error code (see page 102).

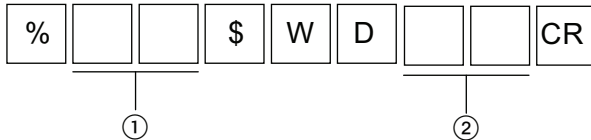

6.1.2 Sensing Settings

Address	Item	Data range	Write	Read	Comment
DT00050	Sampling cycle	0–3	OK	OK	
DT00051	Shutter time	0–31	OK	OK	

6.1.3 Data Processing Settings

Address	Item	Data range	Write	Read	Comment
DT00056	Average function	0–5	OK	OK	
DT00053	Analysis mode	0–3	OK	OK	
DT00061	Zero set	0–1	OK	OK	
DT00062	Value used as zero setting	(Lo)	—	OK	Data type: 2 word
DT00063		(Hi)			
DT00057	Span	(Lo)	OK	OK	Data type: 2 word
DT00058		(Hi)			
DT00059	Offset	(Lo)	OK	OK	Data type: 2 word
DT00060		(Hi)			

(Lo) Lower word

(Hi) Higher word

6.1.4 Output Settings

Address	Item	Data range	Write	Read	Comment
DT00054	Judgment output selection	0–3	OK	OK	
DT00064	Displacement judgment threshold a	(Lo)	OK	OK	Data type: 2 word
DT00065		(Hi)			

Address	Item	Data range	Write	Read	Comment	
DT00066	Displacement judgment threshold b	(Lo)	-9500000 – +9500000	OK	OK	Data type: 2 word
DT00067		(Hi)				
DT00068	Displacement judgment hysteresis	(Lo)	-000000 – +9500000	OK	OK	Data type: 2 word
DT00069		(Hi)				
DT00055	Judgment output OFF delay	0–7	OK	OK		
DT00088	Measurement value display on panel	0–2	OK	OK		

6.1.5 Analog Settings

Address	Item	Data range	Write	Read	Comment	
DT00070	Analog output selection	0–1	OK	OK		
DT00071	Analog scaling (measurement value A)	(Lo)	-9500000 – +9500000	OK	OK	Data type: 2 word
DT00072		(Hi)				
DT00073	Analog scaling (measurement value B)	(Lo)	-9500000 – +9500000	OK	OK	Data type: 2 word
DT00074		(Hi)				
DT00075	Analog scaling (voltage a)	(Lo)	-9500000 – +9500000	OK	OK	Data type: 2 word
DT00076		(Hi)				
DT00077	Analog scaling (voltage b)	(Lo)	-9500000 – +9500000	OK	OK	Data type: 2 word
DT00078		(Hi)				
DT00079	Analog scaling (current a)	(Lo)	-9500000 – +9500000	OK	OK	Data type: 2 word
DT00080		(Hi)				
DT00081	Analog scaling (current b)	(Lo)	-9500000 – +9500000	OK	OK	Data type: 2 word
DT00082		(Hi)				

6.1.6 Alarm Settings

Address	Item	Data range	Write	Read	Comment
DT00083	Analog output at alarm	0–1	OK	OK	
DT00084	Digital output at alarm	0–1	OK	OK	
DT00085	Alarm delay	0–65535	OK	OK	

6.1.7 System Settings

Address	Item	Data range	Write	Read	Comment
DT00104	Memory selection	0–3	OK	OK	
DT00105	Timing mode	0–1	OK	OK	
DT00106	Laser control	0–1	OK	OK	
DT00107	Eco mode	0–2	OK	OK	

Address	Item	Data range	Write	Read	Comment
DT00108	Initialize	0-1	OK	—	
DT00109	Save	0-1	OK	—	
DT00111	Timing	0-1	OK	OK	
DT00112	Reset	0-1	OK	OK	

6.1.8 Data Readout

Address	Item	Data range	Write	Read	Comment
DT00400	Read measurement value	(Lo)	—	OK	Data type: 2 word
DT00401		(Hi)			Data type: 2 word
DT00414	Read received light intensity	0-4095	—	OK	
DT00410	Alarm status	0-1	—	OK	
DT00411	Read OUT1	0-1	—	OK	
DT00412	Read OUT2	0-1	—	OK	
DT00413	Read OUT3	0-1	—	OK	

6.1.9 Buffering Settings

Address	Item	Data range	Write	Read	Comment
DT01950	Buffering mode	0-1	OK	OK	
DT01951	Buffering rate	1-65535	OK	OK	
DT01952	Data amount	1-3000	OK	OK	
DT01953	Trigger point	1-3000	OK	OK	Set a value \leq value set for "Data amount"
DT01954	Trigger delay	0-65535	OK	OK	
DT01955	Trigger condition	0-4	OK	OK	
DT01956	Trigger threshold	(Lo)	OK	OK	Data type: 2 word
DT01957		(Hi)			
DT01959	Read buffering status	0-3	—	OK	
DT01960	Buffering operation	0-1	OK	OK	
DT01962	Last data point	0-3000	—	OK	
DT02000	Read buffered data No. 1	(Lo)	—	OK	Reading out data until last data point Data type: 2 word
DT02001		(Hi)			
↓	↓	-9500000 – +9500000	—	OK	
DT07998	Read buffered data No. 3000	(Lo)	—	OK	
DT07999		(Hi)			

6.2 Settings for Programmable Display (GT Series)

For more details about these settings, refer to the User's Manual (dedicated Console Version).

Address	Item	Data range		Write	Read	Comment
DT00113	Display hold	0	OFF	OK	OK	Holds the measurement values stored in DT00400/00401
		1	ON			
DT00089	Display console measurement value	0	FULL	OK	OK	Displays the measurement values stored in DT00400/00401 with the number of digits selected.
		1	Set 1			
		2	Set 2			
		3	Set 3			
DT00117	Backlight color display	0	White / Green	OK	OK	
		1	Red if OUT2 = ON			
		2	Red if OUT2 = OFF			
DT00119	Touch beep	0	ON	OK	OK	
		1	OFF			

Chapter 7

Troubleshooting

7.1 Problems and Remedies

If an error occurs during operation or you suspect a system failure, identify the possible cause and carry out the corresponding remedy.

Problems can be classified into 5 types:

Type	Description
1	Problem with the sensor head settings
2	Problem with the communication control
3	Problem with the the measurement method or display of measurement values
4	Problem with the alarm or error LED indication
5	Problem with the laser emission



◆ NOTE

- **If the digital display does not show any measurement values, it is possible that the status of the output data is undefined (see page 31).**
- **If it seems that the sensor does not accept any setting changes, refer to the section on "Memory Selection" (see page 50).**

Type	Problem	Possible cause	Remedy
1	<ul style="list-style-type: none"> • The sensor head indicator does not light up. • The sensor head does not operate. 	The connecting cable is not connected properly.	Check the connection between the sensor head and connection cable.
		The connecting cable is disconnected.	Check the wiring between the connection cable and connector.
		Power is not supplied to the controller.	Check the connection between the 24V DC external power supply and the sensor head.
		The operation of the sensor head is stopped.	Turn the sensor head ON again.
		The eco mode is set to "Eco-FULL".	The LED will be lit by operating any switch. Change the eco-mode settings, if necessary.
		The laser control setting has been turned OFF and this setting has been saved.	Set the laser control setting to ON and save the setting, otherwise the system will start with the laser beam turned OFF.
3	There is a difference between the actual distance to the measurement object and measurement value.	The measurement object is fluctuating or vibrating.	Stop the fluctuation or vibration of the measurement object.
		The measurement object is tilted.	Place the measurement object as perpendicularly as possible.
		The received light waveform is saturated or insufficient.	Adjust the received light intensity using the shutter time.
3	The correct measurement value is not displayed.	The measurement object is out of the measuring range.	Check the measuring range of the sensor head used.
		The scaling setting is not correct.	Set the correct scaling.
		The light emitter/receiver is dirty.	Remove the dirt on the light emitter/receiver.

Type	Problem	Possible cause	Remedy
3	Measurement values vary.	The moving average is small.	Increase the number of moving average.
		The light emitter/receiver is dirty.	Remove the dirt on the light emitter/receiver.
		The mounting direction of the sensor head is incorrect.	Check the mounting direction of sensor head.
		The sensor head or measurement object is tilted.	Check the mounting of the sensor head and the setting position of the measurement object.
2	<ul style="list-style-type: none"> RS485 communication control fails. Normal communication via RS422/485 is not possible. 	The wiring is incorrect.	<ul style="list-style-type: none"> RS422 and RS485 communication require different wiring. Connect the wires correctly. Use a twisted-pair cable to ensure stable communication.
		The RS422/485 connecting cable is disconnected.	Check the connection between RS422/485 cable and connector.
		The connection mode and/or baud rate are incorrect.	Select the correct connection mode and baud rate.
		The communication settings for the external device are incorrect.	Check whether the communication settings of the external device match the communication settings in the sensor.
		The sensor number settings are incorrect.	If a number of sensors are connected over RS485, every sensor needs to have a unique sensor number.
		The wrong sensor has been selected as the terminating sensor.	Only set the last sensor as the terminating resistor (R3). For all other sensor heads, the terminating resistor setting must be OFF.
		The communication quality is reduced as a result of the wiring condition.	<ul style="list-style-type: none"> The communication condition may be improved by lowering the baud rate. The communication condition may be improved by selecting the setting R1 or R2 for the terminating resistor.
		An incorrect data format or command is transmitted.	Refer to the error codes and send the data with the correct format and command.
		Several commands are sent continuously without waiting for the response from the controller.	Send the next command after the controller transmits the response to the previous command.
The settings were not saved while RS422/485 communication was used.	You must send the "Save" command after you have changed settings. If you do not save the new settings, all changes will be discarded when you turn the power OFF.		

Type	Problem	Possible cause	Remedy
3, 4	The alarm indicator lights up and measurement is no longer possible (see note).	The reflected beam from the beam emitter is blocked.	Move the position of the beam projection spot or change the mounting direction of the sensor head so the reflected beam should not be blocked.
		The laser beam spot is applied to the R portion (curved surface) of the measurement object.	Apply the beam projection spot to the top of R portion or adjust the beam diameter so it comes larger by moving the measurement object back and forth within the measuring range.
		The reflected beam has directionality because the surface of the object is hairline-finished.	Check the mounting direction of the sensor head.
		The received light intensity is insufficient because the sampling cycle is too short.	Set a longer sampling cycle or shutter time (when shutter time is set to a fixed value).
		The sampling cycle is too long and the received light intensity is too strong.	Set a shorter sampling cycle and reduce the received light intensity by setting a shorter shutter time.





◆ NOTE

If an alarm occurs, check the error code of the alarm output by reading the output status with a serial command (see page 96).

7.2 Initialize

This function is used to delete all the settings from all the memories and returns them to the default settings.

- You need to save the settings after initialization (see page 46), or the system will operate with the settings valid before the initialization at the next system start.
- When the initialization of the system is executed through the operation of the panel, all settings except COM settings  and system settings  will return to the factory default settings.
- When you are using the multifunction type and initialize the settings with a serial command, send the "Save" command immediately afterwards, or the system will operate with the settings valid before the initialization at the next system start.
- While the initialization is executed, the output data status may become undefined temporarily.

Chapter 8

Specifications

8.1 Sensor Head Specifications

The sensor head specifications are listed in the table below.



◆ NOTE

The following measurement conditions apply unless otherwise specified:

- **Power voltage: 24V DC**
- **Ambient temperature: 20°C**
- **Sampling cycle: 500µs**
- **Number of measurement values used for averaging: 1024 values**
- **Measurement object: white ceramic**

Where standard and multifunction type differ in the specification, the table row is shaded in gray.

Characteristic	Model No.			
	HL-G103-□-□	HL-G105-□-□	HL-G108-□-□	HL-G112-□-□
Supply voltage	24V DC ±10% including ripple 0.5V (P-P)			
Current consumption	100mA max.			
Measurement method	Diffuse reflection			
Measurement center distance	30mm	50mm	85mm	120mm
Measuring range	±4mm	±10mm	±20mm	±60mm
Beam source	Red semiconductor laser Class 2 (JIS/IEC/FDA laser notice No. 50) Max output: 1mW, Emission peak wavelength: 655nm			
Beam dimensions (see note 1)	0.1×0.1mm	0.5×1mm	0.75×1.25mm	1.0×1.5mm
Beam receiving element	CMOS image sensor			
Resolution	0.5µm	1.5µm	2.5µm	8µm
Linearity	±0.1% F.S.			
Temperature characteristics	±0.08% F.S./°C			
Sampling cycle	200µs, 500µs, 1ms, 2ms			
Analog output	Voltage: <ul style="list-style-type: none"> • Output range: 0 to 10.5V (normal), 11V (at alarm) • Output impedance: 100Ω Current: <ul style="list-style-type: none"> • Output range: 3.2 to 20.8mA (normal), 21.6mA (at alarm) • Load impedance: 300Ω max. 			

Characteristic	Model No.			
	HL-G103-□-□	HL-G105-□-□	HL-G108-□-□	HL-G112-□-□
OUT1 OUT2 OUT3	Judgment output or alarm output (switchable) NPN open-collector transistor/PNP open-collector transistor (switchable)			
	Settings for NPN: <ul style="list-style-type: none"> • Peak in-flow current: 50mA • Applied voltage: 3 to 24V DC (between output and 0V) • Residual voltage: 2V max. (at in-flow current of 50mA) Settings for PNP: <ul style="list-style-type: none"> • Peak in-flow current: 50mA • Residual voltage: 2.8V max. (at in-flow current of 50mA) 			
Output operation	Open when the output is ON.			
Short-circuit protection	Incorporated (Auto-reset)			
NPN/PNP type switching input	At 0V: NPN open-collector output At supply voltage of 24V DC: PNP open-collector output			
Timing input	<ul style="list-style-type: none"> • NPN operation: ON when connecting or connected to 0V (depending on settings) • PNP operation: ON when connecting or connected to positive terminal of external power supply (depending on settings) 			
Communication interface (multifunction type only!)	RS422 or RS485 Baud rate: 9,600/19,200/38,400/115,200/230,400/460,800/921,600bps Data length: 8 bits, stop bit length: 1 bit, parity check: none, BCC: yes, end code: CR			
Multifunction input	Zero set, zero set OFF, reset, memory selection, teaching, save, or laser control depending on input time. <ul style="list-style-type: none"> • NPN operation: Depending on time to connect 0V • PNP operation: Depending on time to connect positive terminal of external power supply 			
Indicators	Laser radiation indicator	Green LED ON at laser radiation		
	Alarm indicator	Orange LED ON when measurement is disabled due to insufficient amount of light		
	Output indicator	Yellow LED (No. of indicators: 3) ON during output		
Digital display	Red LED for sign and 5-digit display			
Degree of protection	<ul style="list-style-type: none"> • Standard type (HL-G1□-A-C5): IP67 • Multifunction type (HL-G1□-S-J): IP67 (without connector) 			
Pollution degree	2			
Insulation resistance	20MΩ min. at 250V DC megger (between charged parts and casing)			
Dielectric withstand	1000V AC for 1 min. (between charged parts and casing)			
Vibration resistance	Endurance: 10 to 55Hz (at 1-minute cycle), 1.5-mm double-amplitude two hours each in X, Y, and Z directions			
Shock resistance	500m/s ² three times each in X, Y, and Z directions			
Ambient illumination (see note 2)	3,000lx max. (illumination level of light receiving surface under incandescent light)			
Ambient temperature	-10°C to 45°C (No dew condensation or icing allowed), at storage: -20°C to +60°C			
Ambient humidity	35 to 85% RH, at storage: 35 to 85% RH			
Altitude	2000m or less			

Characteristic	Model No.			
	HL-G103-□-□	HL-G105-□-□	HL-G108-□-□	HL-G112-□-□
Material	Casing: PBT, front cover: acrylic, cable: PVC			
Cable length	<ul style="list-style-type: none"> Standard type (HL-G1□-A-C5): 5m Multifunction type (HL-G1□-S-J): 0.5m 			
Weight	<ul style="list-style-type: none"> Standard type (HL-G1□-A-C5): Approx. 70g (without cable), approx. 320g (including cable), and approx. 380g (with packing) Multifunction type (HL-G1□-S-J): Approx. 70g (without cable), approx. 110g (including cable), and approx. 160g (with packing) 			
Accessory	Laser warning label: 1 set			
Applicable standards	Conforming to EMC Directive			



◆ NOTE

1. The beam dimensions are defined by the size of the object at the measurement center distance and determined by $1/e^2$ (approximately 13.5%) of the center beam intensity. Light reflections and leak lights may affect the measurement value.
2. Variance is $\pm 0.1\%$ F.S. or less depending on the ambient light.

8.2 Beam Dimensions

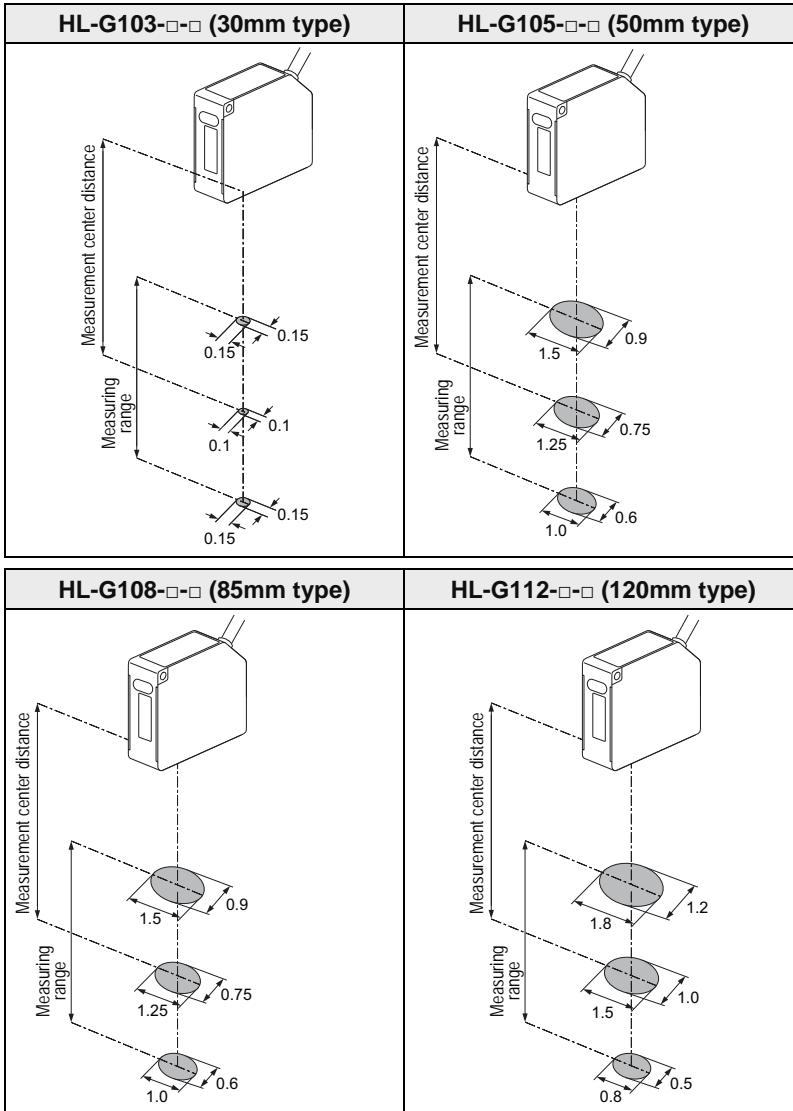

8.2.1 Mutual Interference Area



◆ **NOTE**

If you install two or more diffuse reflective sensor heads side by side, mutual interference will occur if the laser spots of the other sensor heads fall within the area shown in gray. Install the sensor heads so that the laser spots of the other sensor heads will fall outside the area shown in gray.

30mm type (HL-G103-□-□)

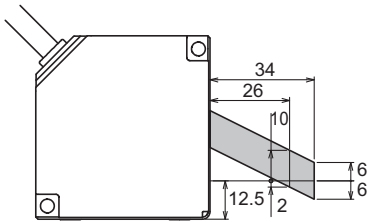

50mm type (HL-G105-□-□)

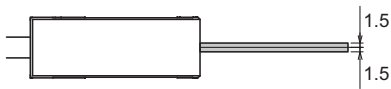
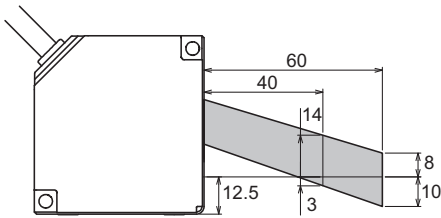

85mm type (HL-G108-□-□)

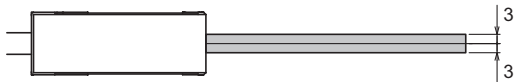
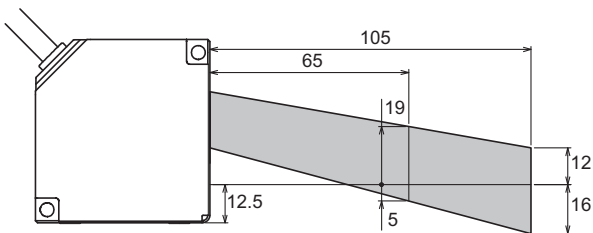

120mm type (HL-G112-□-□)

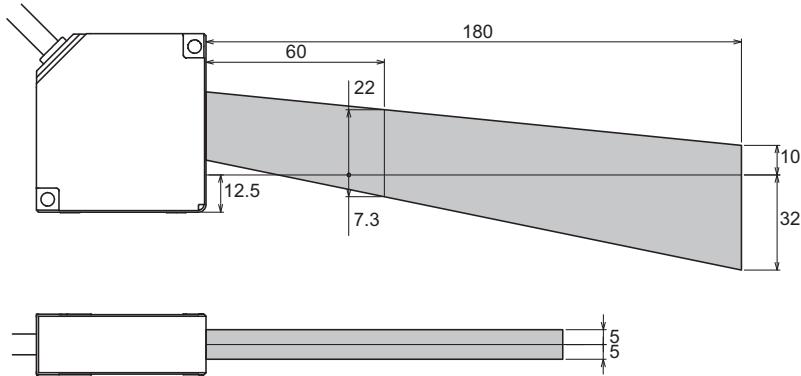

8.2.2 Output Characteristics

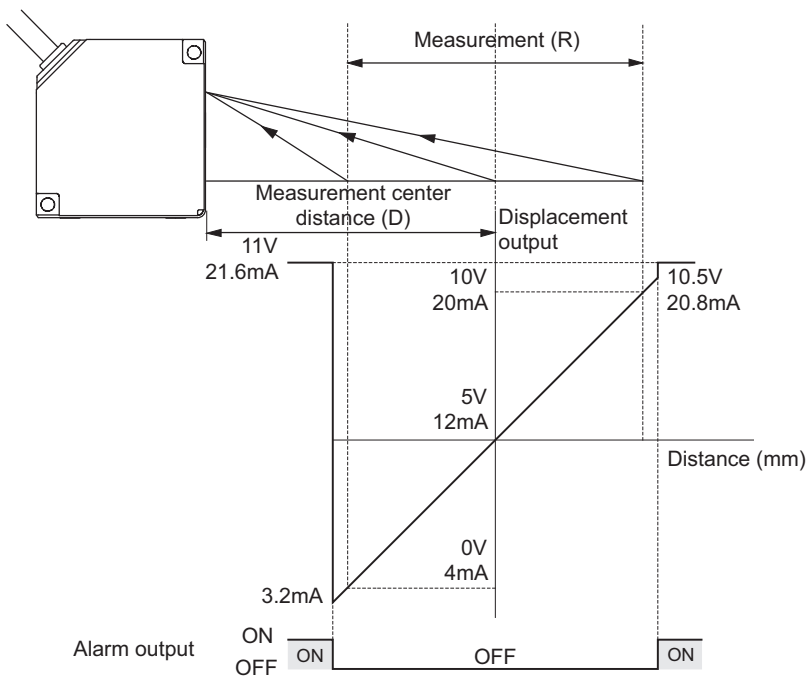

◆ NOTE

In the figure, the default settings for analog output are used.

	Standard type	Multifunction type	Measurement center distance (D)	Measuring range (R)
30mm type	HL-G103-A-C5	HL-G103-S-J	30mm	±4mm
50mm type	HL-G105-A-C5	HL-G105-S-J	50mm	±10mm
85mm type	HL-G108-A-C5	HL-G108-S-J	85mm	±20mm
120mm type	HL-G112-A-C5	HL-G112-S-J	120mm	±60mm

8.3 Sensor Head Dimensions

All dimensions are in mm.

8.3.1 Standard Type (HL-G1□□-A-C5)

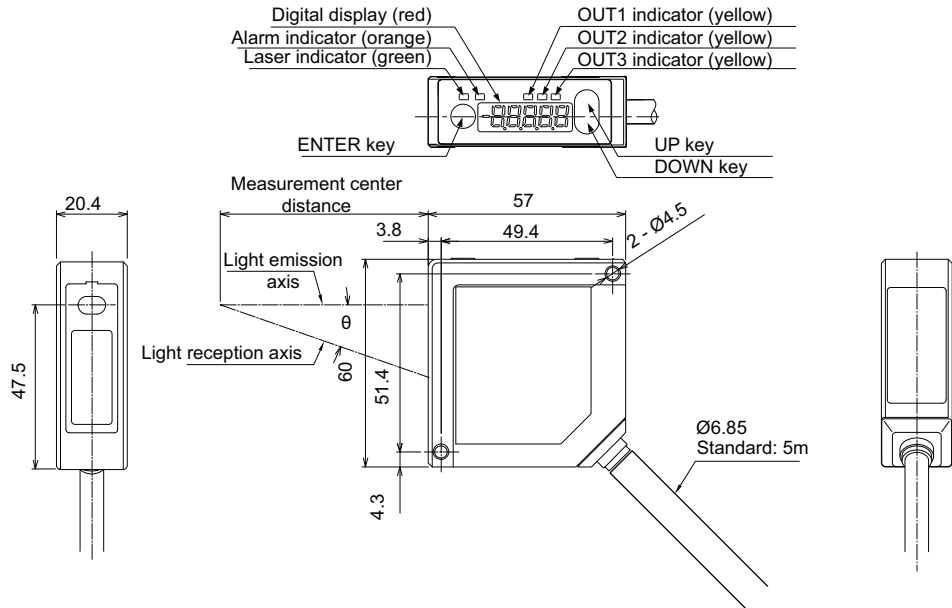

8.3.2 Multifunction Type (HL-G1□□-S-J)

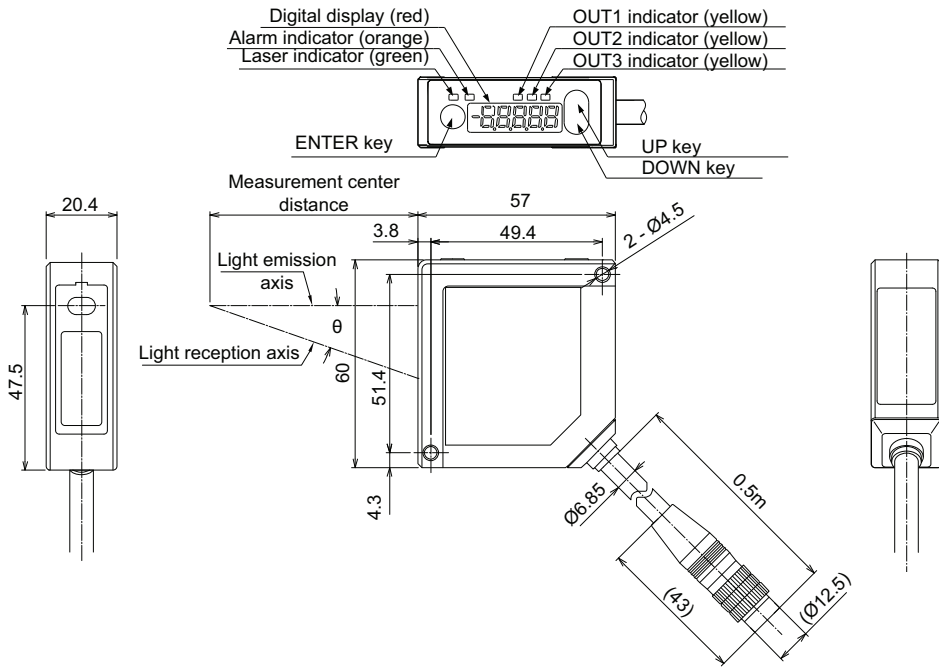

Index

1

1:

- 1 communication 74, 89
- n communication 74, 90

2

- 2-state 60

3

- 3-state 60

A

- Alarm 43, 68, 69
- Alarm delay 69
- Analog output at alarm 39, 68
- Analog output selection 39, 65
- Analog scaling 39, 66
- Analysis mode 39, 55
- Average times 39, 54

B

- Baud rate 39, 73, 88
- BCC 103
- Binary readout of buffering data 39, 79, 100
- Buffering 39, 79, 98

C

- Changing numerical values 44, 93
- Communication is unstable 71, 88
- Communication method 88
- Communication speed 73, 88
- Compact console 15, 27
- Connecting the sensor to other devices . 14

- Connection cables 15, 18
- Connection mode 39, 74
- Control panel 17, 43, 46
- Current output 65, 68

D

- Data amount 39, 79, 96
- Decimal point 43, 93
- Default settings 39
- Differential data format 99
- Digital display 43, 64
- Digital output at alarm 39, 68
- Displacement judgment 39, 61

E

- Eccentricity measurement 55
- Eco mode 39, 78
- Entering numerical values 44
- Error codes 102

F

- Fixed value 68, 69

G

- GT panel 15, 116

H

- Hold 33, 68, 69
- Hysteresis 61

I

- Independent 60
- Indicators 17, 43, 78

J

- Judgment output OFF delay 39, 63

Judgment output selection39, 60

L

Laser class2

Laser control39, 77

Laser wavelength2

Last data point39, 79

LEDs17, 43, 78

Light intensity monitor39, 52, 53

Logic60

M

Measurement center distance 61, 124, 127

Measurement value display on panel39,
64

Measuring mode39, 55

Measuring range127

Memory39

Memory selection39, 50

MEWTOCOL110

MI input26, 39, 83, 84

Moving targets19

Multiplication factor56

N

NPN/PNP switching24

O

Offset39, 58

One-shot33, 76

P

Peak / valley measurement33, 55

Peak measurement33

Peak-to-peak measurement33, 55

Power supply5, 24

R

R371

Reset26, 33, 44, 84

Rotating targets19

S

Sampling cycle39, 51

Saving the settings45, 46

Scaling66

Sending delay time39, 75

Sensor number39, 72

Serial command list103

Serial communication88, 91

Shutter aperture52

Shutter time39, 52

Signal length for MI input26

Signal processing33

Span39, 56

Specifications123

 Communication via RS422/RS48588

 Outputs28

Status readout79, 96

T

Targets in narrow spaces or slots19

Targets with level differences19

Terminating resistor selection39, 71

Threshold a and b44, 61

Timing input27, 46

Timing mode27, 33, 76

Touch terminal15

Trigger condition39, 79

Trigger delay39, 79

Trigger point39, 79

Turn digits off on the digital display64

U

Undefined output data ...31, 33, 43, 45, 54,
77

USB-RS422/485 converter 14

V

Valley33, 55

Version.....79

View version39, 79

Voltage output.....65, 68

W

Warning label.....6, 17

Z

Zero set.....26, 33, 44

Zero-set OFF26, 39, 59

Record of Changes

Manual number	Date	Changes
MEUEN-HLG1V1	May 2011	First edition, based on ME-HLG1(02) No. 022-79V