

F3SJ-A

Safety Light Curtains

- Resolution: 14 mm (0.55 in.), 20 mm (0.79 in.), 25 mm (1.01 in.), 30 mm (1.18 in.), or 55 mm (2.17 in.)
- Range: 7 m (23 ft.) or 9 m (29.5 ft.) dependent on minimum object resolution and protected height
- Protected heights: 14 mm protected heights from 245 to 1631 mm (9.6 to 64 in.), 20 mm, 25 mm and 30 mm protected heights from 245 to 2495 mm (9.6 to 98 in.), 55 mm from 270 to 2470 mm (10.6 to 97 in.)
- Very compact size – 30 x 24 mm (1.18 x 0.94 in.)
- Cascaded designs possible – 4 segments, up to 400 beams
- Partial muting and position detection muting
- Cross-talk prevention



Description

Position Detection Muting Function

Position Detection Muting Function is used in applications where the workpiece is set in position each time by an operator, and a turntable or positioning robot then moves the workpiece to the area where the work is performed. A limit switch or other means is used to detect when the robot is in a safe position and muting is then applied.



Warning Zone Function

With the F3SJ-A, part of the detection zone can be used as warning zone to generate an alarm when someone approaches the danger zone. If the person then enters the danger zone the F3SJ-A will send a stop signal to the guarded machine. In addition, the auxiliary output can be used to activate a flashing lamp to alert the person in the warning zone.

The detection zone for a single F3SJ-A can be divided into two zones or set a single warning zone for multiple, cascaded F3SJ-A units.

Dividing the zone between series-connected sensors

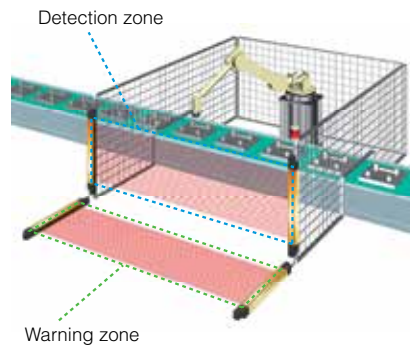

Partial Muting Function

Muting temporarily disables the F3SJ-A when an object must pass through the detection zone, such as when supplying a workpiece to your equipment.

Partial muting increases the level of safety by only muting the beams of the safety light curtain where the workpiece passes through, while preventing muting in all other areas.

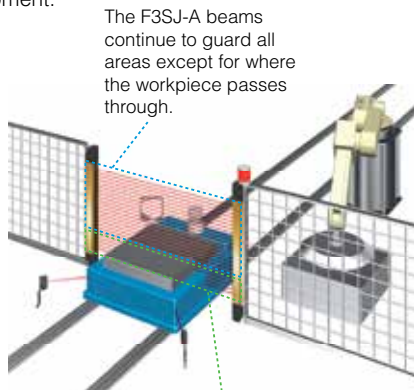

The F3SJ-A beams continue to guard all areas except for where the workpiece passes through.

Only the beams of the safety light curtain interrupted by the workpiece are muted.

SD Manager Software

Using the SD Manager software, all features of the F3SJ-A can be set and checked. Features include:

- Display of system specifications:
 - Model
 - Number of beams
 - Minimum object resolution
 - Response time
- Settings for:
 - Fixed blanking
 - Floating blanking
 - Warning zone configuration
 - Muting – Both partial and position detection
 - External indicator function
 - Auxiliary outputs
 - EDM parameters
 - Operating range
- Monitoring of received and ambient light intensity
- Maintenance information:
 - Power on time
 - OSSD switching frequency
- Recovery of settings
- Safety distance calculations based on parameters for connected system

Setting Console

When you don't want to take a computer into the field with you the F39-MC21 setting console is a convenient way to set parameters and check the system status.

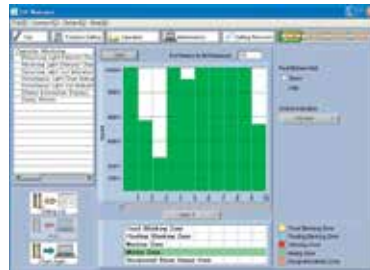
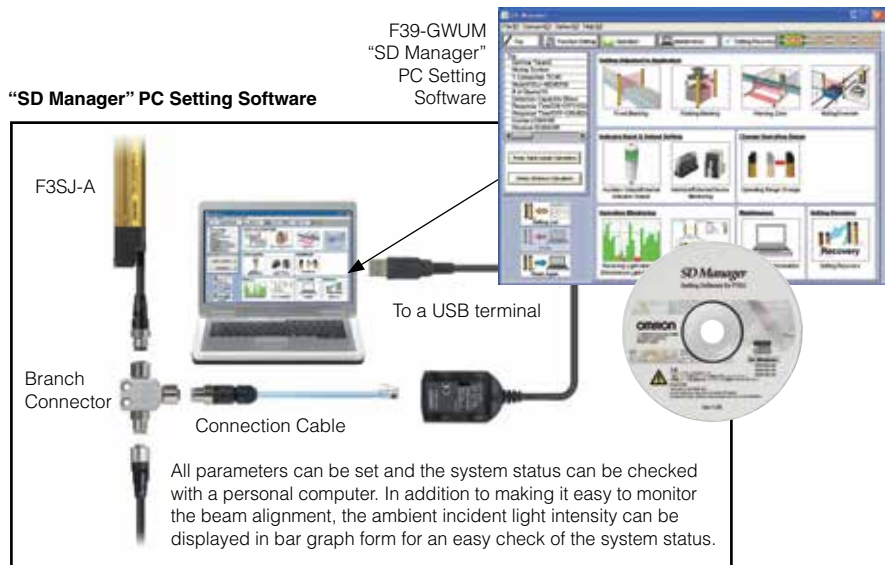

Beam Alignment is Easier

The incident light level can be displayed in a bar graph for each beam.

Applications

With built-in muting and blanking functions, the F3SJ-A can be employed in a wide variety of applications from robotic work cells to small machines. The potential for cascaded design and a broad selection of minimum object resolutions adds to this versatility.

Selecting the Best Configuration

Space Efficient and Low Cost

The built-in external device monitoring function eliminates the need for a safety relay unit.

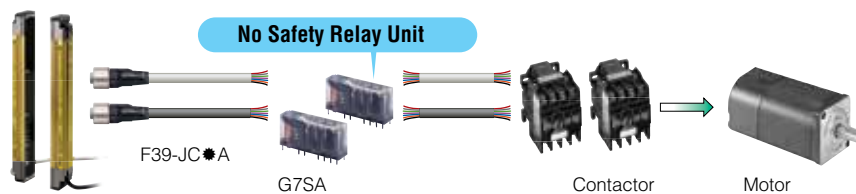

Reduced Wiring and Easy Maintenance

Cables with connectors on both ends simplify connections and prevent wiring errors.

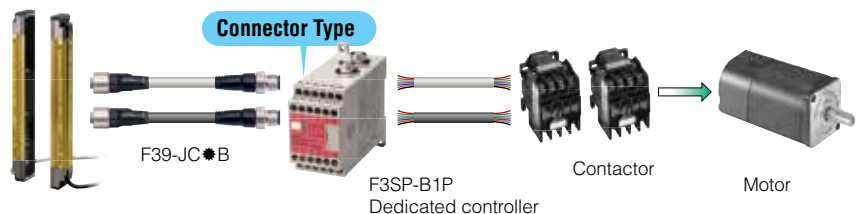

Specifications

Performance	
Resolution:	14 mm, 20 mm, 25 mm, 30 mm, 55 mm
Protected Height:	14 mm – 245 to 1631 mm (9.6 to 64.2 in.) 20 mm, 25 mm and 30 mm – 245 to 2495 mm (9.6 to 98.2 in.) 55 mm – 270 to 2470 mm (10.6 to 97.2 in.)
Operating Range:	0.2 to 9 m for all protective heights up to 1640 mm (64.6 in.) 0.2 to 7 m for all protective heights longer than 1640 mm (64.6 in.);
Effective Aperture Angle:	±2.5° maximum, transmitter and receiver at operating range greater than 3 m (9.8 ft.)
Response Time:	For 14 mm resolution systems up to 983 mm (38.7 in.) protected height ≤17.5 ms For 14 mm resolution systems above 983 mm (38.7 in.) protected height ≤25 ms For 20 mm resolution systems up to 1205 mm (47.4 in.) protected height ≤15 ms For 20 mm resolution systems above 1205 mm (47.4 in.) protected height ≤22.5 ms For 25 mm resolution systems up to 1600 mm (63.0 in.) protected height ≤15 ms For 25 mm resolution systems above 1600 mm (63.0 in.) protected height ≤20.0 ms For 30 mm resolution systems, all protected heights ≤17.5 ms For 55 mm resolution systems, all protected heights ≤13 ms
Safety Output Rating:	Two 24 VDC PNP outputs sourcing 300 mA max.
Auxiliary (Non-Safety) Output Ratings:	One 24 VDC PNP output sourcing 300 mA max.
Light Source:	Infrared LED, 870 nm
Indicators:	Transmitter: 5 LED Light Level Indicators, 3 LED Error Indicators, Power, Interlock, EDM, Blanking/Test Receiver: 5 LED Light Level Indicators, 3 LED Error Indicators, Machine Run, Machine Stop
Mechanical	
Enclosure:	Anodized aluminum housing
Cable Length:	Optional cables are available up to 20 m (65.6 ft.) in length
Transmitter and Receiver Cable Connections:	M12, 8-pin
Electrical	
Power Supply:	24 VDC ± 20%
Environmental	
Protection Rating:	IP65
Operating Temperature:	-10 to 55°C (14 to 131°F)
Storage Temperature:	-30 to 70°C (-22 to 158°F)
Relative Humidity:	35 to 85% non-condensing
Vibration:	10 to 55 Hz, double amplitude of 0.7 mm, 20 sweeps in X, Y, and Z directions
Shock:	100 m/s ² , 1000 times each in X, Y and Z directions
Approvals	ESPE Type 4 (IEC 61496-1/-2) Category 4 / PL e (EN ISO 13849-1) SIL3 / SIL3 CL3 (IEC 61508)UL508, UL1998, CAN/CSA-C22.2 No. 14, CAN/CSA-C22.2 No. 0.8

Specifications are subject to change without notice.

F3SP-B1P Control Unit

Power Supply Voltage:	24 VDC ±10%
Power Consumption:	DC1.7 W max (not including sensor's current consumption)
Operation Time:	100 ms max. (not including the sensor's response time)
Response Time:	10 ms max. (not including the sensor's response time)
Relay Output	
Number of Contacts:	3 N.O., 1 N.C.
Rated Load:	250 VAC 5 A (cos = 1); 30 VDC 5 A L/R = 0 ms
Rated Current:	5 A
Connection Type	
Between Sensors:	M12 connector (8-pin)
Others:	Terminal block
Weight:	Approx. 280 g (9.9 oz.)

Specifications are subject to change without notice.

Wiring

Wiring for Single F3SJ-A Application

Detection of a welded relay contact is possible without a controller relay unit.

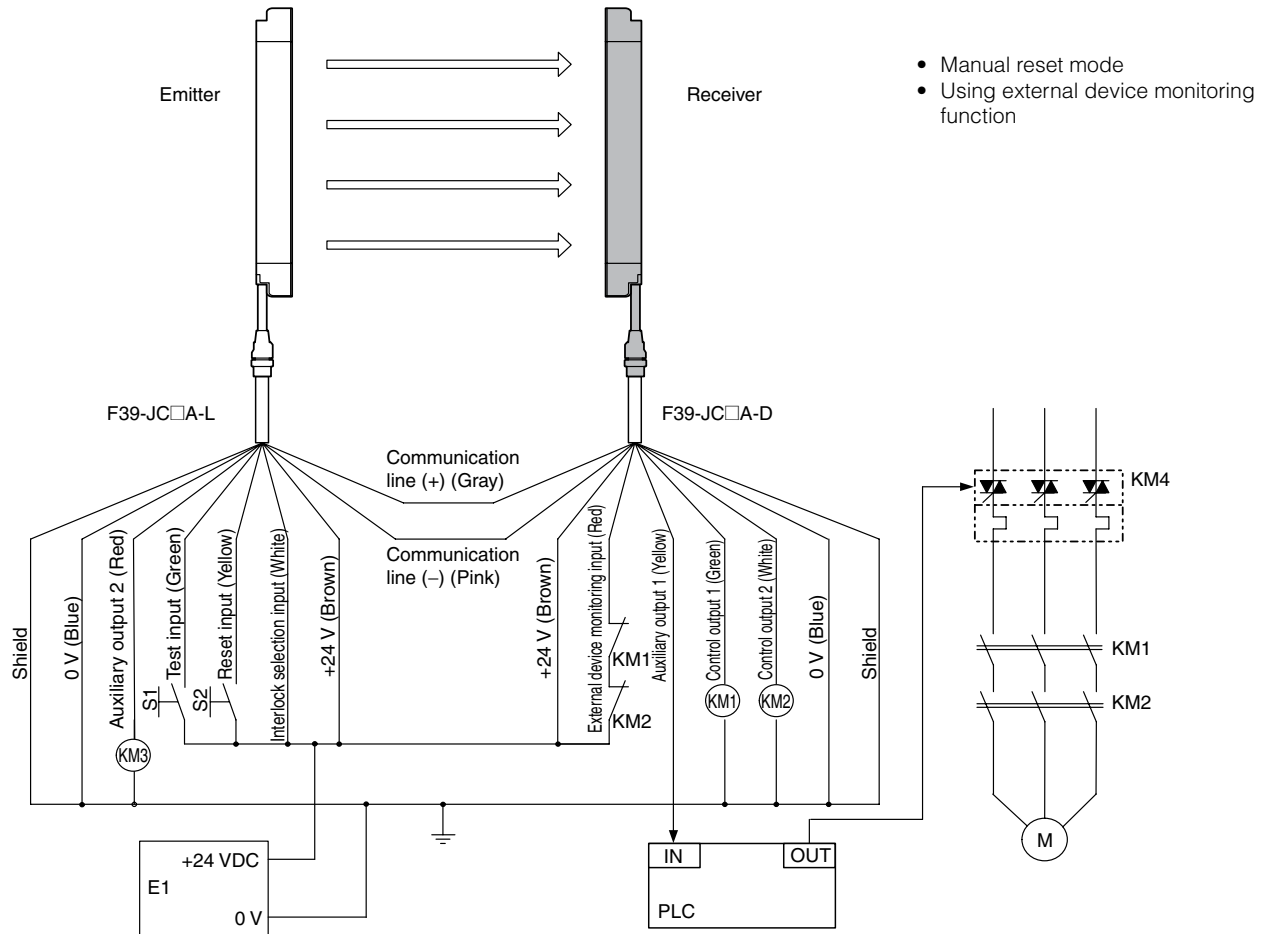

Dimensions

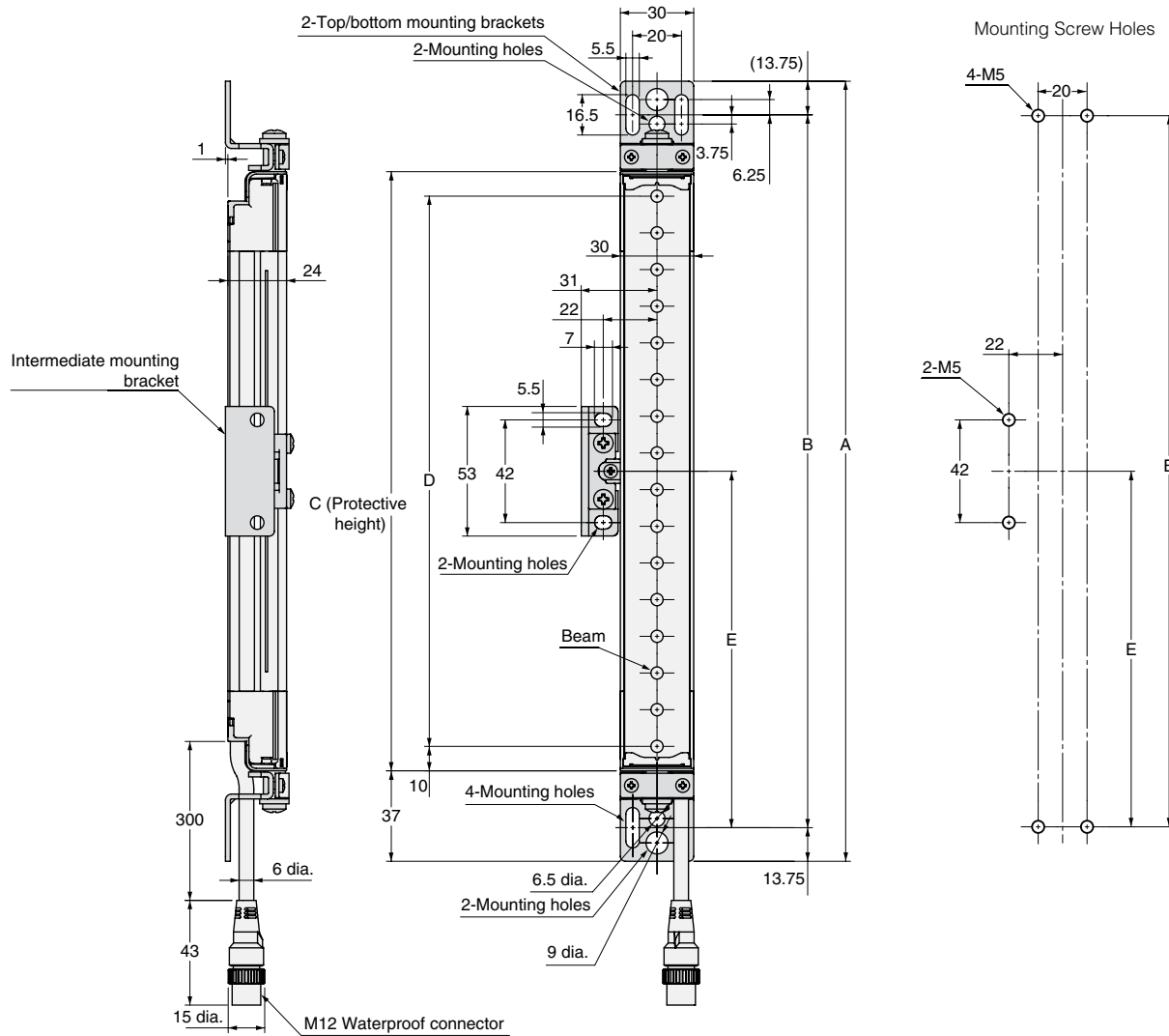

How to Calculate Your System Dimensions:

C (protective height) = 4-digit number in the table

A = C + 74

B = C + 46.5

D = C - 20

E = see chart below

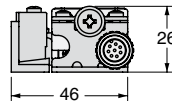

Protective Height	Number of Intermediate Brackets	E*
245 to 596 mm (9.6 to 23.5 in.)	0	—
600 to 1130 mm (23.6 to 44.5 in.)	1	E = B/2
1136 to 1658 mm (44.7 to 65.3 in.)	2	E = B/3
1660 to 2180 mm (65.4 to 85.8 in.)	3	E = B/4
2195 to 2500 mm (86.4 to 98.4 in.)	4	E = B/5

*Use E = 530 or less when none of the E values shown above are used.

Ordering

The minimum components required for an F3SJ-A system are a emitter receiver set and a set of single or double-ended connector cables. See the table below for an overview of the versions available. The pages which follow provide specific part numbers and accessory descriptions.

Safety Light Curtain F3SJ-A

Designator	Protection	Detection	Beam Gap	Operating Range	No. of Beams	Protective Height
F3SJ-A□□□□P14 ¹	Finger	14 mm	9 mm	0.2 to 9 m (0.7 to 29.5 ft.)	26 to 197	245 to 1784 mm (9.6 to 70.2 in.)
F3SJ-A□□□□P20 ¹	Finger/Hand	20 mm	15 mm	0.2 to 9 m (0.7 to 29.5 ft.)	16 to 100	245 to 1505 mm (9.6 to 59.3 in.)
F3SJ-A□□□□P20 ¹	Finger/Hand	20 mm	15 mm	0.2 to 7 m (0.7 to 23.0 ft.)	110 to 166	1655 to 2495 mm (65.2 to 98.2 in.)
F3SJ-A□□□□P20-TS ²	Finger/Hand	20 mm	15 mm	0.2 to 9 m (0.7 to 29.5 ft.)	16 to 100	245 to 1505 mm (9.6 to 59.3 in.)
F3SJ-A□□□□P20-TS ²	Finger/Hand	20 mm	15 mm	0.2 to 7 m (0.7 to 23.0 ft.)	110 to 166	1655 to 2495 mm (65.2 to 98.2 in.)
F3SJ-A□□□□P25 ¹	Hand	25 mm	20 mm	0.2 to 9 m (0.7 to 29.5 ft.)	13 to 79	260 to 1580 mm (10.2 to 62.2 in.)
F3SJ-A□□□□P25 ¹	Hand	25 mm	20 mm	0.2 to 7 m (0.7 to 23.0 ft.)	87 to 125	1740 to 2500 mm (68.5 to 98.4 in.)
F3SJ-A□□□□P25-TS ²	Hand	25 mm	20 mm	0.2 to 9 m (0.7 to 29.5 ft.)	13 to 79	260 to 1580 mm (10.2 to 62.2 in.)
F3SJ-A□□□□P25-TS ²	Hand	25 mm	20 mm	0.2 to 7 m (0.7 to 23.0 ft.)	87 to 125	1740 to 2500 mm (68.5 to 98.4 in.)
F3SJ-A□□□□P30 ¹	Hand/arm	30 mm	25 mm	0.2 to 9 m (0.7 to 29.5 ft.)	10 to 65	245 to 1620 mm (9.6 to 63.8 in.)
F3SJ-A□□□□P30 ¹	Hand/arm	30 mm	25 mm	0.2 to 7 m (0.7 to 23.0 ft.)	70 to 100	1745 to 2495 mm (68.7 to 98.2 in.)
F3SJ-A□□□□P55 ¹	Leg/body	55 mm	50 mm	0.2 to 9 m (0.7 to 29.5 ft.)	6 to 33	270 to 1620 mm (10.6 to 63.8 in.)
F3SJ-A□□□□P55 ¹	Leg/body	55 mm	50 mm	0.2 to 7 m (0.7 to 23.0 ft.)	36 to 50	1770 to 2470 mm (69.7 to 97.2 in.)

Notes: Connection cables are not included with the products and must be purchased separately as needed.

Specific Model Numbers

Model	No. of Beams	Protective Height (mm)
F3SJ-A14 Series		
F3SJ-A0245P14	26	245
F3SJ-A0254P14	27	254
F3SJ-A0263P14	28	263
F3SJ-A0281P14	30	281
F3SJ-A0290P14	31	290
F3SJ-A0299P14	32	299
F3SJ-A0308P14	33	308
F3SJ-A0317P14	34	317
F3SJ-A0335P14	36	335
F3SJ-A0353P14	38	353
F3SJ-A0371P14	40	371
F3SJ-A0389P14	42	389
F3SJ-A0407P14	44	407
F3SJ-A0425P14	46	425
F3SJ-A0443P14	48	443
F3SJ-A0452P14	49	452
F3SJ-A0461P14	50	461
F3SJ-A0479P14	52	479
F3SJ-A0497P14	54	497
F3SJ-A0515P14	56	515
F3SJ-A0533P14	58	533
F3SJ-A0551P14	60	551
F3SJ-A0569P14	62	569
F3SJ-A0578P14	63	578
F3SJ-A0587P14	64	587
F3SJ-A0605P14	66	605
F3SJ-A0623P14	68	623
F3SJ-A0659P14	72	659
F3SJ-A0695P14	76	695
F3SJ-A0731P14	80	731
F3SJ-A0767P14	84	767
F3SJ-A0803P14	88	803

Model	No. of Beams	Protective Height (mm)
F3SJ-A0839P14	92	839
F3SJ-A0875P14	96	875
F3SJ-A0911P14	100	911
F3SJ-A0920P14	101	920
F3SJ-A0983P14	108	983
F3SJ-A1055P14	116	1055
F3SJ-A1127P14	124	1127
F3SJ-A1199P14	132	1199
F3SJ-A1235P14	136	1235
F3SJ-A1271P14	140	1271
F3SJ-A1325P14	146	1325
F3SJ-A1343P14	148	1343
F3SJ-A1415P14	156	1415
F3SJ-A1487P14	164	1487
F3SJ-A1559P14	172	1559
F3SJ-A1631P14	180	1631
F3SJ-A1784P14	197	1784
F3SJ-A2117P14	234	2117
F3SJ-A20, F3SJ-A20-TS* Series		
F3SJ-A0245P20	16	245
F3SJ-A0260P20	17	260
F3SJ-A0275P20	18	275
F3SJ-A0290P20	19	290
F3SJ-A0305P20	20	305
F3SJ-A0335P20	22	335
F3SJ-A0350P20	23	350
F3SJ-A0365P20	24	365
F3SJ-A0380P20	25	380
F3SJ-A0395P20	26	395
F3SJ-A0410P20	27	410
F3SJ-A0425P20	28	425
F3SJ-A0440P20	29	440
F3SJ-A0455P20	30	455

Model	No. of Beams	Protective Height (mm)
F3SJ-A0470P20	31	470
F3SJ-A0485P20	32	485
F3SJ-A0500P20	33	500
F3SJ-A0515P20	34	515
F3SJ-A0530P20	35	530
F3SJ-A0545P20	36	545
F3SJ-A0560P20	37	560
F3SJ-A0575P20	38	575
F3SJ-A0590P20	39	590
F3SJ-A0605P20	40	605
F3SJ-A0620P20	41	620
F3SJ-A0635P20	42	635
F3SJ-A0665P20	44	665
F3SJ-A0695P20	46	695
F3SJ-A0710P20	47	710
F3SJ-A0725P20	48	725
F3SJ-A0740P20	49	740
F3SJ-A0755P20	50	755
F3SJ-A0785P20	52	785
F3SJ-A0800P20	53	800
F3SJ-A0815P20	54	815
F3SJ-A0830P20	55	830
F3SJ-A0845P20	56	845
F3SJ-A0875P20	58	875
F3SJ-A0890P20	59	890
F3SJ-A0905P20	60	905
F3SJ-A0920P20	61	920
F3SJ-A0935P20	62	935
F3SJ-A0965P20	64	965
F3SJ-A0980P20	65	980
F3SJ-A0995P20	66	995
F3SJ-A1010P20	67	1010
F3SJ-A1025P20	68	1025

Model	No. of Beams	Protective Height (mm)
F3SJ-A1040P20	69	1040
F3SJ-A1055P20	70	1055
F3SJ-A1070P20	71	1070
F3SJ-A1085P20	72	1085
F3SJ-A1100P20	73	1100
F3SJ-A1115P20	74	1115
F3SJ-A1145P20	76	1145
F3SJ-A1175P20	78	1175
F3SJ-A1205P20	80	1205
F3SJ-A1220P20	81	1220
F3SJ-A1235P20	82	1235
F3SJ-A1250P20	83	1250
F3SJ-A1265P20	84	1265
F3SJ-A1310P20	87	1310
F3SJ-A1325P20	88	1325
F3SJ-A1355P20	90	1355
F3SJ-A1385P20	92	1385
F3SJ-A1445P20	96	1445
F3SJ-A1460P20	97	1460
F3SJ-A1475P20	98	1475
F3SJ-A1490P20	99	1490
F3SJ-A1505P20	100	1505
F3SJ-A1595P20	106	1595
F3SJ-A1655P20	110	1655
F3SJ-A1715P20	114	1715
F3SJ-A1790P20	119	1790
F3SJ-A1805P20	120	1805
F3SJ-A1955P20	130	1955
F3SJ-A2105P20	140	2105
F3SJ-A2255P20	150	2255
F3SJ-A2405P20	160	2405
F3SJ-A2495P20	166	2495

(Continued on next page)

Notes: Connection cables are not included with the products and must be purchased separately as needed.

* The suffix "-TS" is attached to the model number of models with fixed auto reset.

¹ Models with S-mark certification have an

"-S" at the end of the model number. S-mark certification is for equipment sold in South Korea. Example: F3SJ-A0245P14-S.

² Models with fixed auto reset (-TS).

Parameters cannot be set using the F39-MC21 Setting Console or F39-GWUM "SD Manager" Support Software for F3SJ-A.

Ordering (continued)

Model	No. of Beams	Protective Height (mm)
F3SJ-A25, F3SJ-A25-TS* Series		
F3SJ-A0260P25	13	260
F3SJ-A0300P25	15	300
F3SJ-A0340P25	17	340
F3SJ-A0380P25	19	380
F3SJ-A0400P25	20	400
F3SJ-A0460P25	23	460
F3SJ-A0480P25	24	480
F3SJ-A0500P25	25	500
F3SJ-A0540P25	27	540
F3SJ-A0600P25	30	600
F3SJ-A0620P25	31	620
F3SJ-A0660P25	33	660
F3SJ-A0700P25	35	700
F3SJ-A0740P25	37	740
F3SJ-A0760P25	38	760
F3SJ-A0780P25	39	780
F3SJ-A0860P25	43	860
F3SJ-A0880P25	44	880
F3SJ-A0900P25	45	900
F3SJ-A0940P25	47	940
F3SJ-A0960P25	48	960
F3SJ-A0980P25	49	980
F3SJ-A1020P25	51	1020
F3SJ-A1060P25	53	1060
F3SJ-A1100P25	55	1100
F3SJ-A1180P25	59	1180
F3SJ-A1220P25	61	1220
F3SJ-A1260P25	63	1260
F3SJ-A1280P25	64	1280
F3SJ-A1340P25	67	1340
F3SJ-A1420P25	71	1420
F3SJ-A1500P25	75	1500
F3SJ-A1580P25	79	1580
F3SJ-A1740P25	87	1740
F3SJ-A1820P25	91	1820
F3SJ-A1900P25	95	1900
F3SJ-A2060P25	103	2060
F3SJ-A2220P25	111	2220
F3SJ-A2380P25	119	2380
F3SJ-A2420P25	121	2420
F3SJ-A2500P25	125	2500

Model	No. of Beams	Protective Height (mm)
F3SJ-A30 Series		
F3SJ-A0245P30	10	245
F3SJ-A0270P30	11	270
F3SJ-A0295P30	12	295
F3SJ-A0320P30	13	320
F3SJ-A0345P30	14	345
F3SJ-A0370P30	15	370
F3SJ-A0395P30	16	395
F3SJ-A0420P30	17	420
F3SJ-A0445P30	18	445
F3SJ-A0470P30	19	470
F3SJ-A0495P30	20	495
F3SJ-A0520P30	21	520
F3SJ-A0545P30	22	545
F3SJ-A0570P30	23	570
F3SJ-A0595P30	24	595
F3SJ-A0620P30	25	620
F3SJ-A0645P30	26	645
F3SJ-A0670P30	27	670
F3SJ-A0695P30	28	695
F3SJ-A0720P30	29	720
F3SJ-A0745P30	30	745
F3SJ-A0770P30	31	770
F3SJ-A0795P30	32	795
F3SJ-A0820P30	33	820
F3SJ-A0845P30	34	845
F3SJ-A0870P30	35	870
F3SJ-A0895P30	36	895
F3SJ-A0920P30	37	920
F3SJ-A0945P30	38	945
F3SJ-A0970P30	39	970
F3SJ-A0995P30	40	995
F3SJ-A1020P30	41	1020
F3SJ-A1045P30	42	1045
F3SJ-A1070P30	43	1070
F3SJ-A1095P30	44	1095
F3SJ-A1120P30	45	1120
F3SJ-A1145P30	46	1145
F3SJ-A1170P30	47	1170
F3SJ-A1195P30	48	1195
F3SJ-A1220P30	49	1220
F3SJ-A1245P30	50	1245

Model	No. of Beams	Protective Height (mm)
F3SJ-A1270P30	51	1270
F3SJ-A1295P30	52	1295
F3SJ-A1320P30	53	1320
F3SJ-A1345P30	54	1345
F3SJ-A1395P30	56	1395
F3SJ-A1420P30	57	1420
F3SJ-A1445P30	58	1445
F3SJ-A1470P30	59	1470
F3SJ-A1495P30	60	1495
F3SJ-A1520P30	61	1520
F3SJ-A1545P30	62	1545
F3SJ-A1570P30	63	1570
F3SJ-A1620P30	65	1620
F3SJ-A1695P30	68	1695
F3SJ-A1745P30	70	1745
F3SJ-A1770P30	71	1770
F3SJ-A1795P30	72	1795
F3SJ-A1820P30	73	1820
F3SJ-A1870P30	75	1870
F3SJ-A1895P30	76	1895
F3SJ-A1920P30	77	1920
F3SJ-A1995P30	80	1995
F3SJ-A2120P30	85	2120
F3SJ-A2245P30	90	2245
F3SJ-A2370P30	95	2370
F3SJ-A2495P30	100	2495
F3SJ-A55 Series		
F3SJ-A0270P55	6	270
F3SJ-A0320P55	7	320
F3SJ-A0370P55	8	370
F3SJ-A0420P55	9	420
F3SJ-A0470P55	10	470
F3SJ-A0520P55	11	520
F3SJ-A0570P55	12	570
F3SJ-A0620P55	13	620
F3SJ-A0670P55	14	670
F3SJ-A0720P55	15	720
F3SJ-A0770P55	16	770
F3SJ-A0820P55	17	820
F3SJ-A0870P55	18	870
F3SJ-A0920P55	19	920
F3SJ-A0970P55	20	970

Model	No. of Beams	Protective Height (mm)
F3SJ-A1020P55	21	1020
F3SJ-A1070P55	22	1070
F3SJ-A1120P55	23	1120
F3SJ-A1170P55	24	1170
F3SJ-A1220P55	25	1220
F3SJ-A1270P55	26	1270
F3SJ-A1320P55	27	1320
F3SJ-A1370P55	28	1370
F3SJ-A1420P55	29	1420
F3SJ-A1470P55	30	1470
F3SJ-A1520P55	31	1520
F3SJ-A1570P55	32	1570
F3SJ-A1620P55	33	1620
F3SJ-A1670P55	34	1670
F3SJ-A1720P55	35	1720
F3SJ-A1770P55	36	1770
F3SJ-A1820P55	37	1820
F3SJ-A1870P55	38	1870
F3SJ-A1920P55	39	1920
F3SJ-A1970P55	40	1970
F3SJ-A2020P55	41	2020
F3SJ-A2070P55	42	2070
F3SJ-A2120P55	43	2120
F3SJ-A2170P55	44	2170
F3SJ-A2220P55	45	2220
F3SJ-A2270P55	46	2270
F3SJ-A2320P55	47	2320
F3SJ-A2370P55	48	2370
F3SJ-A2420P55	49	2420
F3SJ-A2470P55	50	2470

Notes: Connection cables are not included with the products and must be purchased separately as needed.

* The suffix "-TS" is attached to the model number of models with fixed auto reset.

¹ Models with S-mark certification have an "-S" at the end of the model number. S-mark certification is for equipment sold in South Korea. Example: F3SJ-A0245P14-S.

² Models with fixed auto reset (-TS). Parameters cannot be set using the F39-MC21 Setting Console or F39-GWUM "SD Manager" Support Software for F3SJ-A.

Ordering (continued)

Accessories

Model	Description
Single-End Connector Cable (2 cables per set, for emitter and receiver) For wiring with safety circuit such as single safety relay, safety relay unit, and safety controller	
F39-JC3A	M12 connector (8-pin), 3 m (9.8 ft.)
F39-JC7A	M12 connector (8-pin), 7 m (23.0 ft.)
F39-JC10A	M12 connector (8-pin), 10 m (32.8 ft.)
F39-JC15A	M12 connector (8-pin), 15 m (49.2 ft.)
F39-JC20A	M12 connector (8-pin), 20 m (65.6 ft.)
Double-End Connector Cable (2 cables per set, for emitter and receiver) For connection with F3SP-B1P control unit, and for extension when series-connected. Note: To extend the cable length under series connection, use F39-JJR3W and F39-JC□B in combination.	
F39-JCR5B	M12 connector (8-pin), 0.5 m (1.6 ft.)
F39-JC1B	M12 connector (8-pin), 1 m (3.3 ft.)
F39-JC3B	M12 connector (8-pin), 3 m (9.8 ft.)
F39-JC5B	M12 connector (8-pin), 5 m (16.4 ft.)
F39-JC7B	M12 connector (8-pin), 7 m (23.0 ft.)
F39-JC10B	M12 connector (8-pin), 10 m (32.8 ft.)
F39-JC15B	M12 connector (8-pin), 15 m (49.2 ft.)
F39-JC20B	M12 connector (8-pin), 20 m (65.6 ft.)
Series Connection Cable (2 cables per set, for emitter and receiver)	
F39-JJR3W	Series connection cable ³ or when using water-resistant case ⁴ , 0.3 m (1.0 ft.)
F39-JC□B	Extension cable, 0.5 to 15 m (1.6 to 49.2 ft.) To change series connection length in combination with F39-JJR3W
F39-JJR06L	Side-by-side series connection cable, 0.06 m (2.4 in.) Dedicated series connection cable with minimum length, used in place of the sensor's cable with connector
F39-JJR15L	Side-by-side series connection cable, 0.15 m (5.9 in.) Dedicated series connection cable with minimum length, used in place of the sensor's cable with connector
Sensor Mounting Brackets (spare parts)	
F39-LJ1	Standard mounting bracket (for top/bottom), included with F3SJ system, 2 for emitter and 2 for receiver (total of 4 per set)
F39-LJ2	Flat side mounting bracket, Use these small-sized brackets when performing side mounting with standard mounting brackets so that they do not protrude from the detection surface, 2 for emitter and 2 for receiver (total of 4 per set)
F39-LJ3	Free-location mounting bracket (also used as standard intermediate bracket), Use these brackets for mounting any place without using standard bracket, 1 set with 2 pieces
Key Cap for Muting	
F39-CN6	Cap attaches to the main unit to enable muting function, attach to either an emitter or a receiver, orange case
Setting Tools⁵	
F39-GWUM	SD Manager Software Accessories: SD Manager CD-ROM, F39-CN1 Branch Connector, Connector Cap, 2 m Dedicated Cable, 0.3 m Dedicated Cable with Plug, Instruction Manual
F39-MC21	Setting Console Accessories: F39-CN1 Branch Connector, Connector Cap, 2 m Dedicated Cable, 0.3 m Dedicated Cable with Plug, Instruction Manual
F39-JC2M	Spare cable for F39-GWUM and F39-MC21

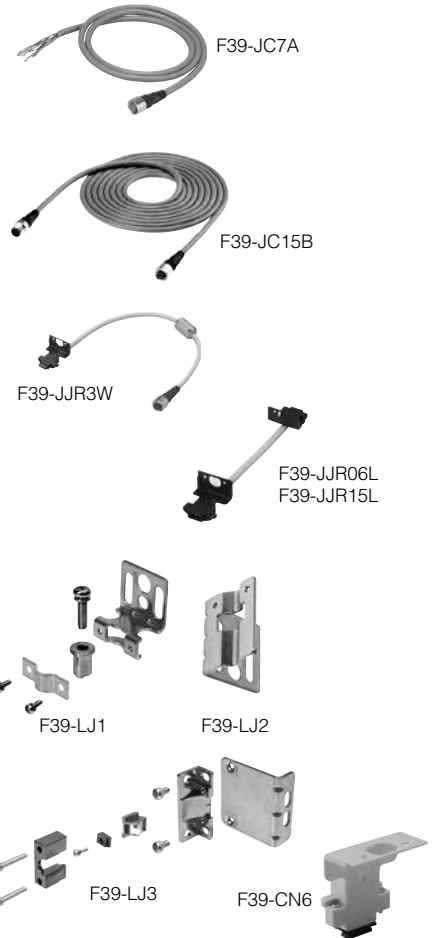

³ Total cable length of series connection is 0.6 m to connect to connector cable of the main sensor unit. For series connection with minimum length, use the F39-JJR06L or F39-JJR15L.

⁴ When using the F39-EJ□□□□-L/D water-resistant case in series connection configurations, use the special series connection cables for the water-resistant case.

(Continued on next page)

Ordering (continued)

Accessories (continued)

Model	Description
Setting Tools⁵	
F39-GWUM	SD Manager Software Accessories: SD Manager CD-ROM, F39-CN1 Branch Connector, Connector Cap, 2 m Dedicated Cable, 0.3 m Dedicated Cable with Plug, Instruction Manual
F39-MC21	Setting Console Accessories: F39-CN1 Branch Connector, Connector Cap, 2 m Dedicated Cable, 0.3 m Dedicated Cable with Plug, Instruction Manual
F39-JC2M	Spare cable for F39-GWUM and F39-MC21
Control Unit	
F3SP-B1P	Relay, 3 N.O. + 1 N.C. output, for connection with F3SJ-A, use an F39-JC□B double-end connector cable
Force-Guided Relays	
G7SA-2A2B	4 contacts, 2 N.O. + 2 N.C., Rated switch load: 250 VAC 6 A, 30 VDC 6 A
G7SA-3A1B	4 contacts, 3 N.O. + 1 N.C., Rated switch load: 250 VAC 6 A, 30 VDC 6 A
G7S-4A2B-E	6 contacts, 4 N.O. + 2 N.C., Rated switch load: 250 VAC 10 A, 30 VDC 10 A
G7S-3A3B-E	6 contacts, 3 N.O. + 3 N.O., Rated switch load: 250 VAC 10 A, 30 VDC 10 A
Dedicated External Indicator Set (Can be connected to either an emitter or a receiver)	
F39-A01PR-PAC	Indicator (red), mounting bracket (1 set), and dedicated connection cable (0.1 m)
F39-A01PG-PAC	Indicator (green), mounting bracket (1 set), and dedicated connection cable (0.1 m)
F39-A01PY-PAC	Indicator (yellow), mounting bracket (1 set), and dedicated connection cable (0.1 m)
General External Indicator Cable	
F39-JJ3N	Cable to connect top of the main unit and an off-the-shelf external indicator (2-wire), 3 m (9.8 ft.)
Spatter Protection Cover	
F39-HJ□□□□	For F3SJ-A series sensor, reduces operating range by 10%, includes two pieces for emitter and receiver
Water-Resistant Case (Set of 1 tube, packing, and dedicated connector cable) When using for both emitter and receiver, order two sets.	
F39-EJ□□□□-L	Water-resistant case for emitter, includes gray cable for emitter
F39-EJ□□□□-D	Water-resistant case for receiver, includes black cable for receiver
F39-EJ-R ⁶	Rear mounting brackets, top/bottom 1 each, total of 2
F39-EJ-S ⁶	Side mounting brackets, top/bottom 1 each, total of 2
F39-JJR3WE-L	Series connection cable for emitter, purchase additionally for series connection when using the water-resistant case
F39-JJR3WE-D	Series connection cable for receiver, purchase additionally for series connection when using the water-resistant case
Branch Connector for F3SX (F39-JC□T to F39-JC□B)	
F39-CN5	Branch connector for F3SX
Wire-Saving Devices	
F39-CN8	Short-circuit connector
F39-TC5P01	Connector terminal box with muting sensor output mode (PNP)
F39-TC5P02	Connector terminal box with override mode (PNP)
F39-TC5N01	Connector terminal box with muting sensor output mode (NPN)
F39-TC5N02	Connector terminal box with override mode (NPN)
F3SP-T01	Safety terminal relays for F3SJ-A_ _B_
Laser Alignment Tool	
F39-PTJ	Laser alignment tool for the F3SJ

⁵ The setting tools described above can be connected only to F3SJ-A models with built-in software of Ver. 2 or later. Note that the setting tools cannot be used with products shipped prior to December 2005. The setting tools cannot be used for setting parameters on the F3SJ-A□-TS series, but the monitoring function can be used.

⁶ Be sure to purchase brackets with the case to match the mounting direction (rear or side).



F39-GWUM



F39-MC21

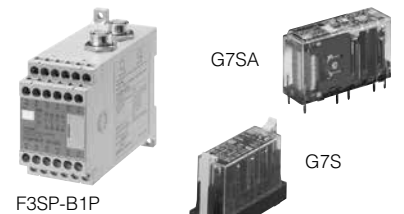

G7SA

G7S

F3SP-B1P

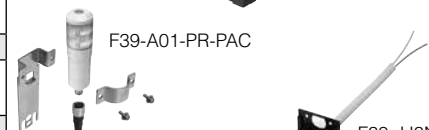

F39-A01-PR-PAC

F39-JJ3N

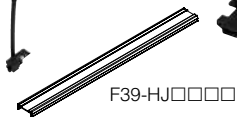

F39-HJ□□□□



F39-EJ□□□□-L/D



F39-EJ-R

F39-EJ-S

F39-TC5



F39-CN5

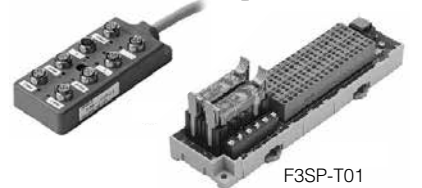

F3SP-T01



F39-PTJ