

Preparation unit——GA Series



GAFC Series F.R.L. combination



Reflux valve is attached

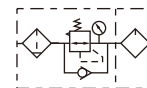

No reflux valve is attached

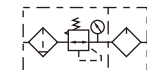

Ordering code

GAFC300 □ **10** □ **S** □ **W T K**

① ② ③ ④ ⑤ ⑥ ⑦ ⑧ ⑨

① Model	② Material of bowl	③ Port size	④ Drain type	⑤ Type code
GAFC200:GA200 Series FR.L unit	Blank: PC N: Nylon C: Metal	06: 1/8" 08: 1/4"	Blank: Semi-auto drain A: Automatic drain	S: Standard L: Lower pressure [Note1]
GAFC300:GA300 Series FR.L unit		08: 1/4" 10: 3/8" 15: 1/2"		
GAFC400:GA400 Series FR.L unit		10: 3/8" 15: 1/2"		
GAFC500:GA500 Series FR.L unit		20: 3/4"		
GAFC600:GA600 Series FR.L unit	C: Metal	20: 3/4" 25: 1"		S: Standard
⑥ Pressure gauge		⑦ Filtering grade	⑧ Thread type	⑨ Reflux valve
Blank: Circular with clip N: No pressure gauge [Note2]		Blank: 40μm W: 5μm	T: NPT (Scale: bar/psi)	Blank: Without reflux valve K: with reflux valve [Note2]

[Note1] The work pressure of lower pressure type is 20~58psi(0.15~0.4MPa);

[Note2] Please refer to page 224 for details of sealing plate Installation and reflux valve.

Product feature

1. Quick and reliable mounting clamps makes it convenient to install and use.
2. The performance of pressure adjustment is reliable with high precision.
3. The efficiency of eliminating moisture and solid grain is high.
4. Two drain types are available: semi-auto drain and automatic drain.
5. Three material of bowl are available: PC, Nylon and metal.

GAFC Series F.R.L. combination

Specification

Model	GAFC20006	GAFC20008	GAFC30008	GAFC30010	GAFC30015	GAFC40010	GAFC40015	GAFC50020	GAFC60020	GAFC60025	
Fluid	Air										
Port size [Note1]	1/8"	1/4"	1/4"	3/8"	1/2"	3/8"	1/2"	3/4"	3/4"	1"	
Filtering grade	40μm or 5μm										
Pressure range	20~130psi(0.15~0.9MPa)										
Max. pressure	145psi(1.0MPa)										
Proof pressure	215psi(1.5MPa)										
Temperature range	-5~70°C(Unfreeze)										
Capacity of drain bowl	25CC		60CC			100CC		108CC	205CC		
Capacity of oil bowl	36CC		98CC			185CC		225CC	410CC		
Recommended lubricant	ISO VG 32or equivalent										
Weight	590g		1020g			1810g		1910g	3430g		
Constitute	Filter-Regulator	GAFR20006	GAFR20008	GAFR30008	GAFR30010	GAFR30015	GAFR40010	GAFR40015	GAFR50020	GAFR60020	GAFR60025
	Lubricator	GAL20006	GAL20008	GAL30008	GAL30010	GAL30015	GAL40010	GAL40015	GAL50020	GAL60020	GAL60025

[Note1] NPT thread is available.

Inner structure

GAFC200

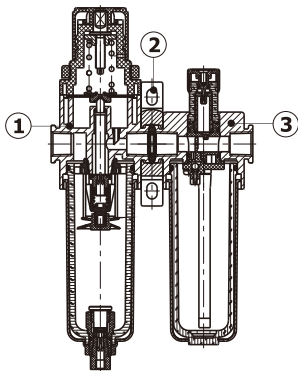

GAFC600

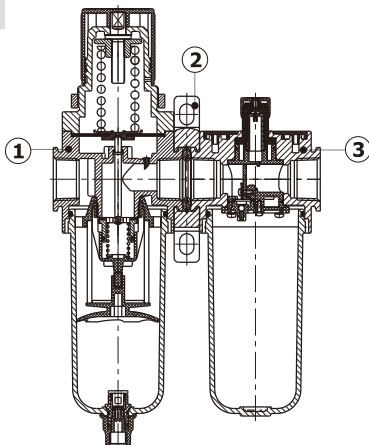

No.	Item
1	GA series filter & regulator
2	Bracket
3	GA series lubricator

Pressure chart

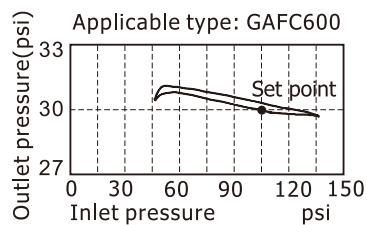
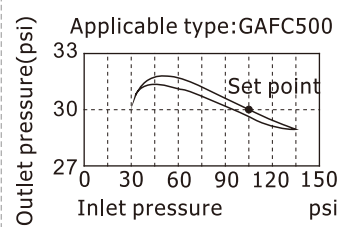
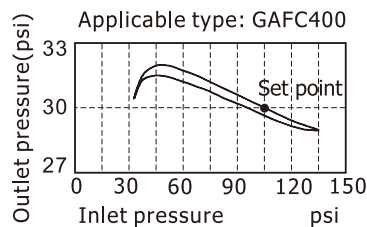
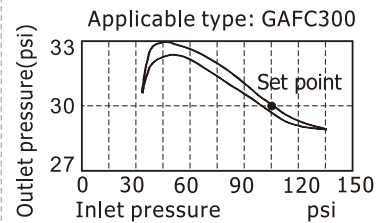
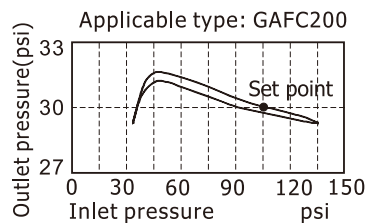

GAFC Series F.R.L. combination

Flow chart

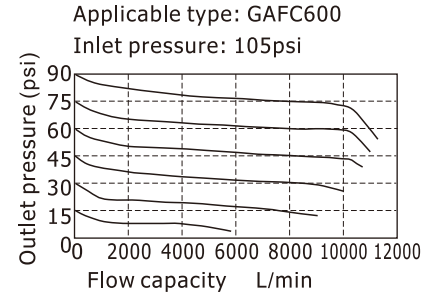
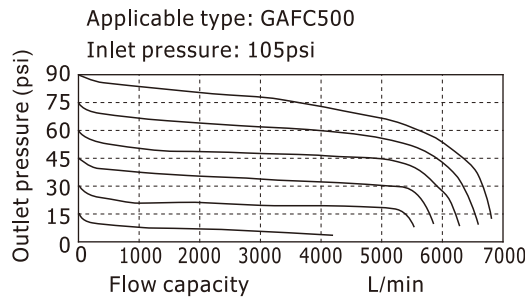
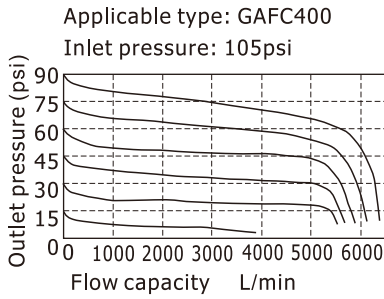
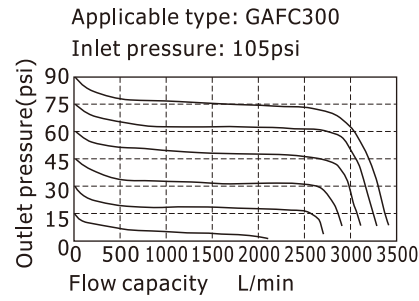
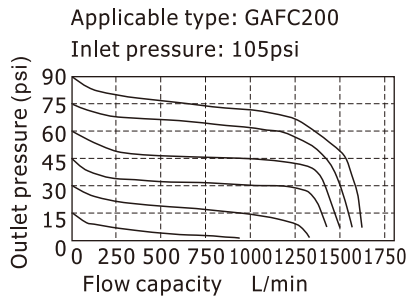

Dimensions

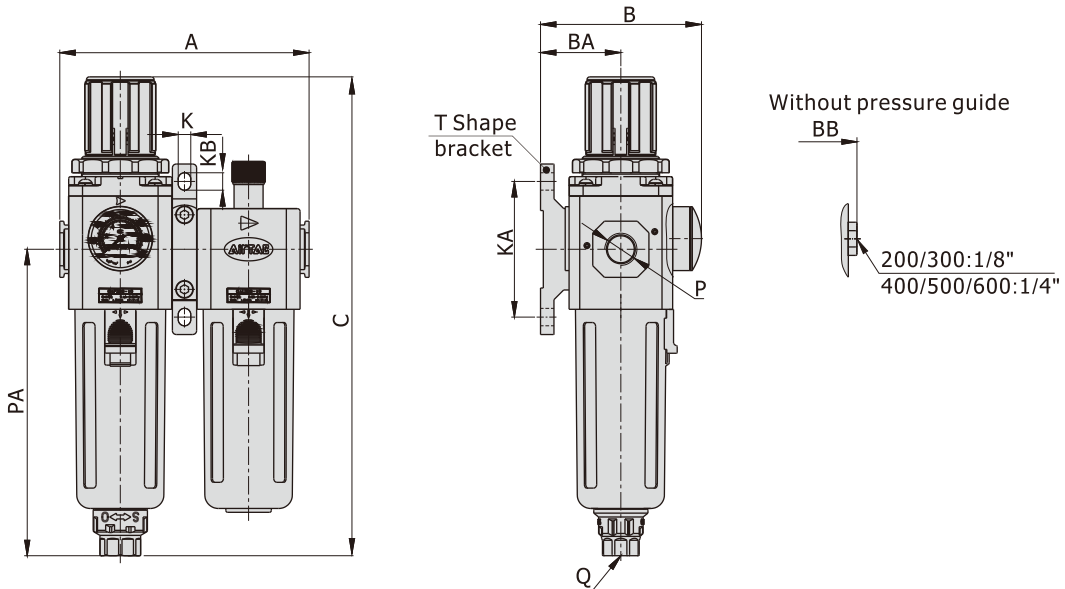

[Unit: mm]

Model\Item	A	B	BA	BB	C	K	KA	KB	P	PA	Q
GAFC200-06	107.5	69	30	55.5	192.5	5.5	50	8.5	1/8"	120	M5X0.8
GAFC200-08	107.5	69	30	55.5	192.5	5.5	50	8.5	1/4"	120	M5X0.8
GAFC300-08	128.5	83	41.5	71.5	247	6.5	70	9	1/4"	158	G1/4
GAFC300-10	128.5	83	41.5	71.5	247	6.5	70	9	3/8"	158	G1/4
GAFC300-15	128.5	83	41.5	71.5	247	6.5	70	9	1/2"	158	G1/4
GAFC400-10	164	99	50	88	285.5	8.6	80	12	3/8"	177.5	G1/4
GAFC400-15	164	99	50	88	285.5	8.6	80	12	1/2"	177.5	G1/4
GAFC500-20	168	100	50	89	299.5	8.6	80	12	3/4"	191.5	G1/4
GAFC600-20	206	128	70	117	336.5	11	100	16	3/4"	205	G1/4
GAFC600-25	206	128	70	117	336.5	11	100	16	1"	205	G1/4