

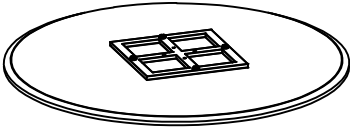

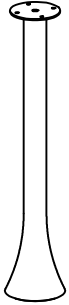

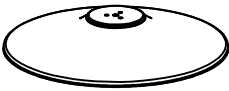





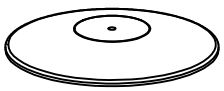

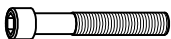

**ITEM NAME / NOM D'ITEM: AURAY BAR TABLE**

**ITEM # / NO.ITEM: 109828/109829/109830**

**PARTS LIST / LISTE DES PIÈCES**

| (1)  | (2)   | (3)   | (4)   | (5)   |
|--|---|---|---|---|
|  |  |  |  |  |
| x1   | x1  | x1  | x1  | x1  |

(7)

|              |   |    |          |   |    |
|--------------|---|----|----------|---|----|
| A. M6 x 16MM |    | x4 | G. Ø10MM |    | x3 |
| B. M8 x 40MM |    | x3 | H. Ø12MM |    | x1 |
| C. M12 x86MM |   | x1 | I. Ø8MM  |   | x4 |
| D. Ø10MM     |  | x3 | J. 4MM   |  | x1 |
| E. Ø12MM     |  | x1 | K. 5MM   |  | x1 |
| F. Ø8MM      |  | x4 | L. 10MM  |  | x1 |

**ASSEMBLY INSTRUCTIONS / INSTRUCTIONS D'ASSEMBLAGE**

I

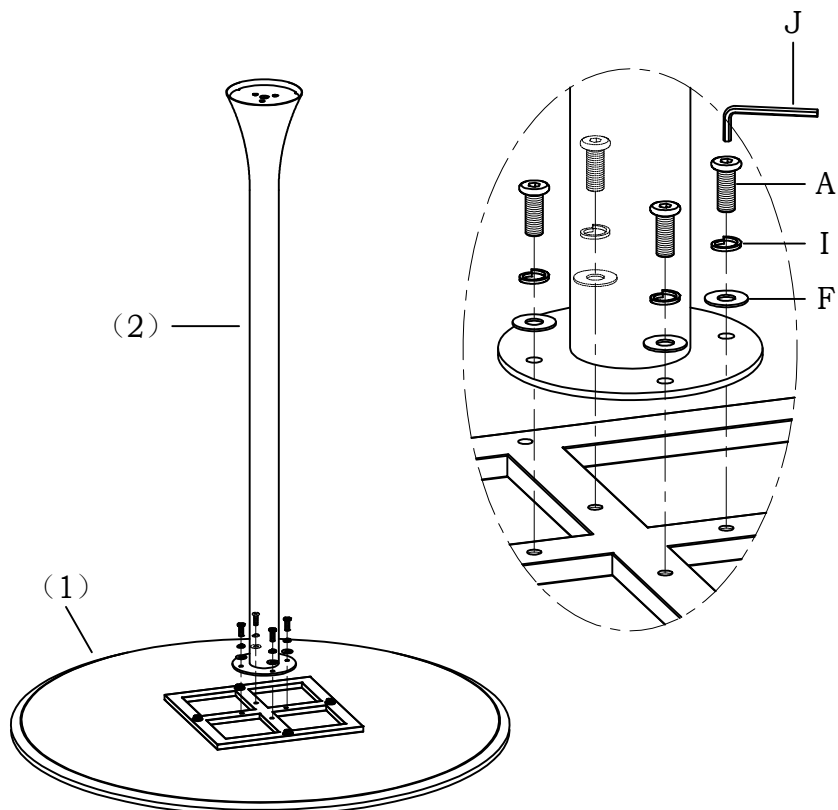

II

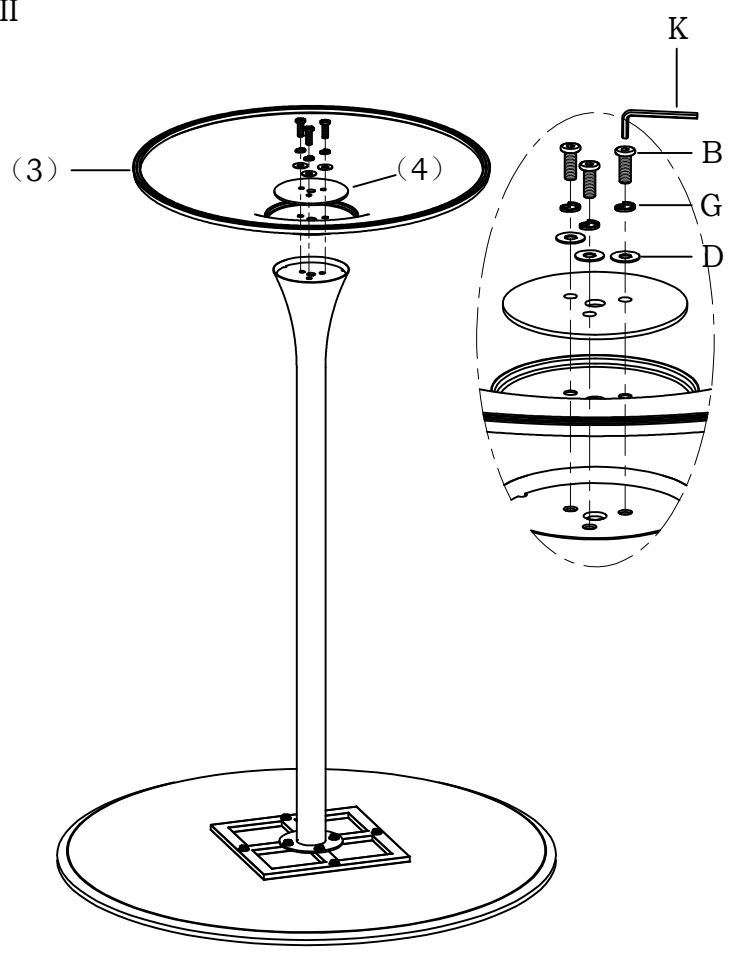

III

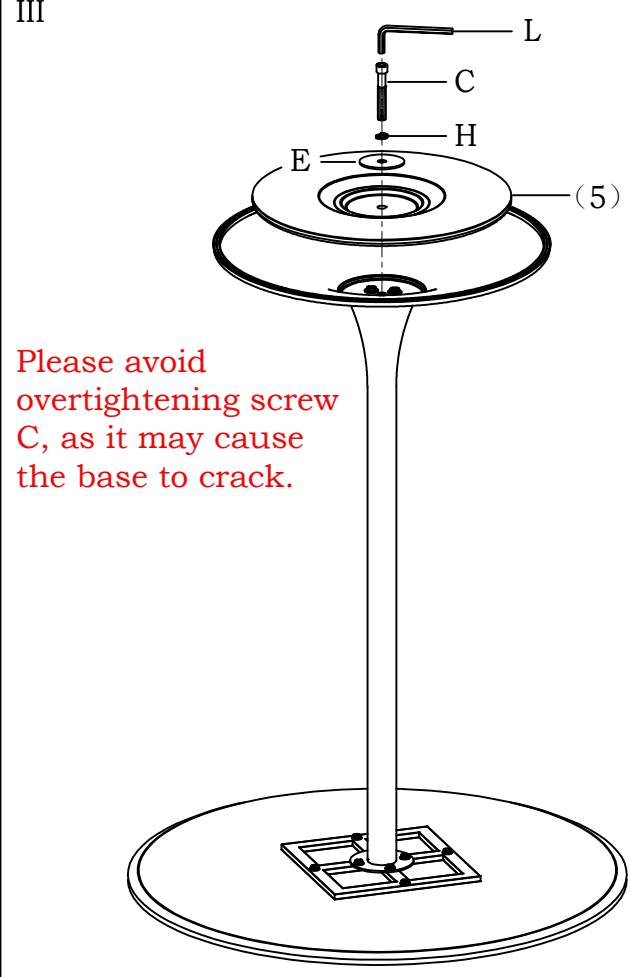

IV

Flip over

