

Dear Customer

Thank you for your order. We hope that you have received your furniture in the pristine condition that we sent it out in.

In the unfortunate event that your order was mishandled during transit, please contact us to let us know the extent of the damages so we can resolve for you as soon as possible.

If replacement parts are required, please email us with images and the part number referenced in this manual and we will have a replacement sent out right away.

We can be reached by the following email: [cs@egtrading.co.uk](mailto:cs@egtrading.co.uk).

Please include the full name and postcode used to place the order in your email so we can locate your order in our systems.

Alternatively, we can be reached by phone (Mon – Fri) on: 0161 401 6140.

The Customer Satisfaction Team

# ASSEMBLING INSTRUCTIONS

 easygift\_products

 easygiftproducts





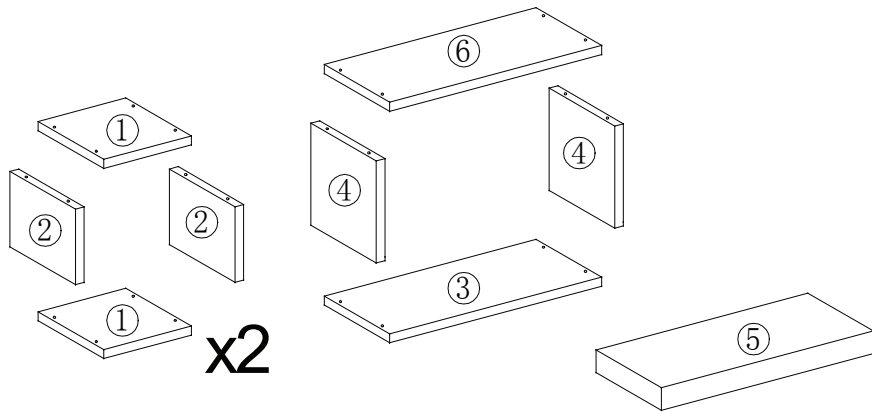

 easygiftproducts.co.uk

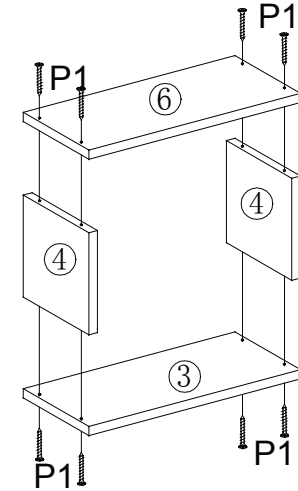
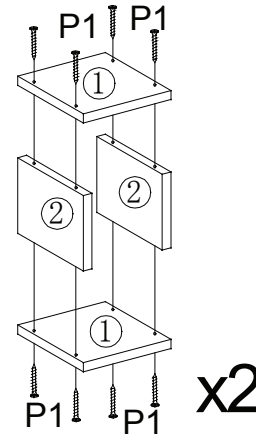



## 1



P1		M4X30mm	24 PCS
P2			8 PCS
P3			2 PCS
P4		M3X14mm	20 PCS
P5			10 PCS
P6			24 PCS
P7		M4X30mm	10 PCS

## 2

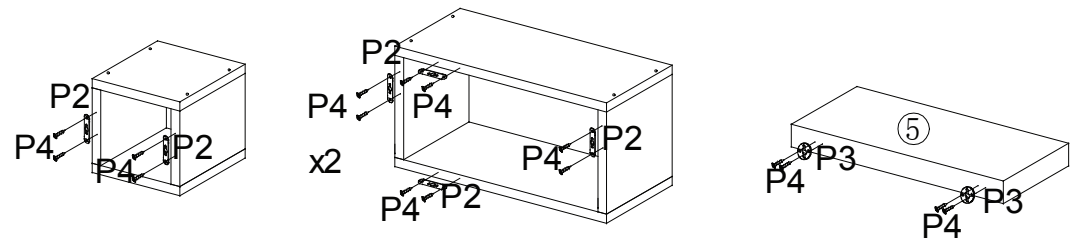

# 3

