

M4 threaded stylus range

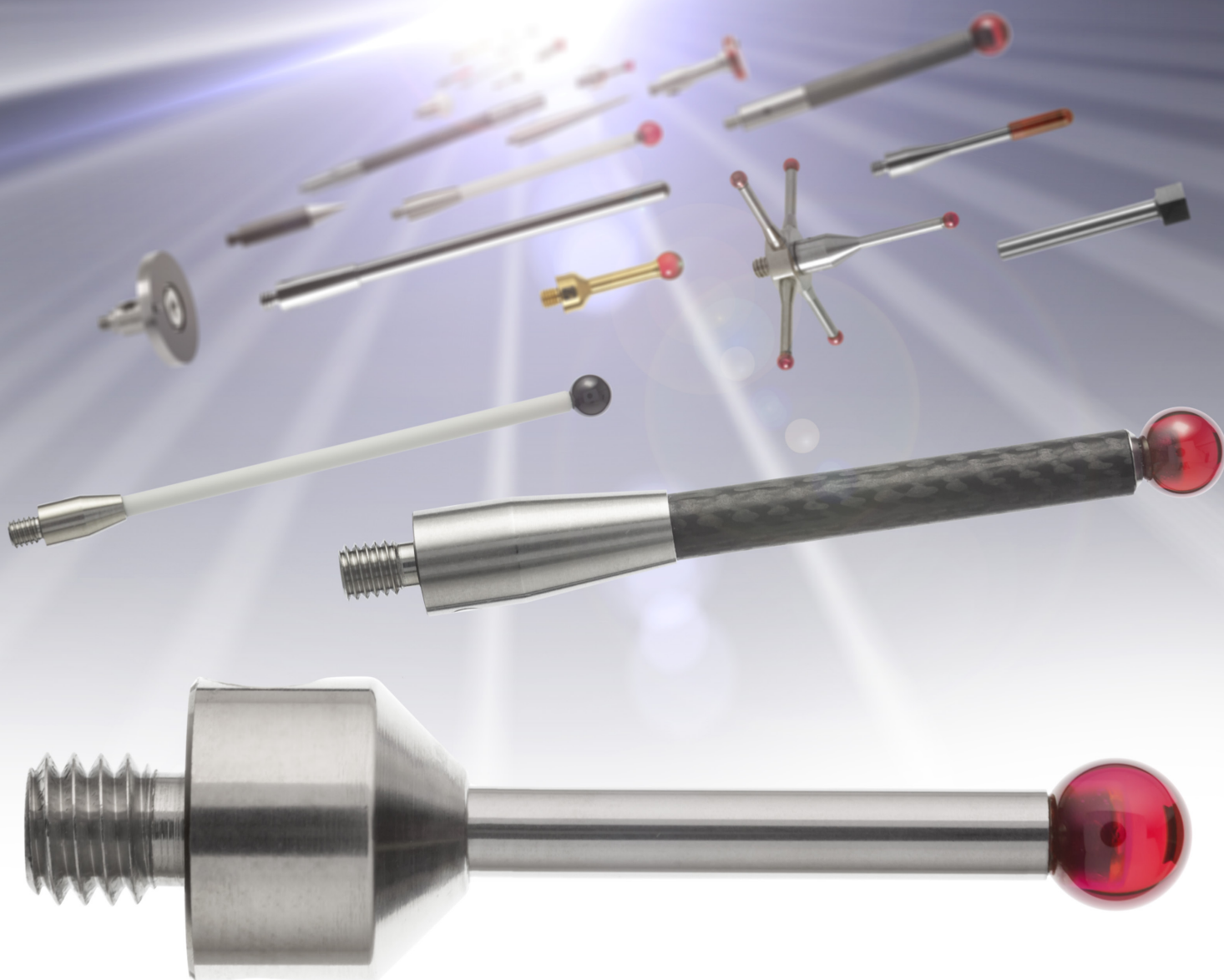

Ruby ball styli (stainless steel stems)

Ball material	Part number				
Ruby	A-5000-6350	A-5000-7545	A-5000-7547	A-5000-7549	A-5000-7551
Silicon nitride			A-5003-5728		A-5003-5729
Zirconia			A-5003-5742		A-5003-5743
A Ball dia. mm (in.)	5.0 (0.20)	1.0 (0.04)	2.0 (0.08)	3.0 (0.12)	4.0 (0.16)
B Length mm (in.)	10.0 (0.40)	19.5 (0.77)	19.0 (0.75)	18.5 (0.73)	18.0 (0.71)
C Stem dia. mm (in.)	3.0 (0.12)	0.7 (0.028)	1.4 (0.05)	2.0 (0.08)	3.0 (0.12)
D EWL* mm (in.)	5.0 (0.20)	4.5 (0.18)	9.2 (0.36)	13.0 (0.52)	13.7 (0.54)
Mass grammes	1.9	2.5	2.3	2.0	2.1

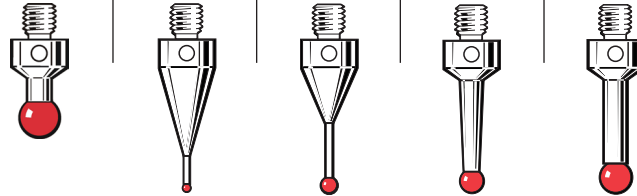

Part number	A-5000-7553	A-5000-6731	A-5000-6352	A-5000-7555	A-5000-7557
A Ball dia. mm (in.)	5.0 (0.20)	5.0 (0.20)	5.0 (0.20)	6.0 (0.24)	8.0 (0.32)
B Length mm (in.)	17.5 (0.69)	20.0 (0.79)	30.0 (1.19)	17.0 (0.67)	16.0 (0.63)
C Stem dia. mm (in.)	3.5 (0.14)	3.0 (0.12)	3.0 (0.12)	4.5 (0.18)	6.0 (0.24)
D EWL* mm (in.)	13.6 (0.55)	15.89 (0.63)	26.0 (1.03)	13.3 (0.53)	16.0 (0.63)
Mass grammes	2.3	2.4	3.0	3.0	3.9

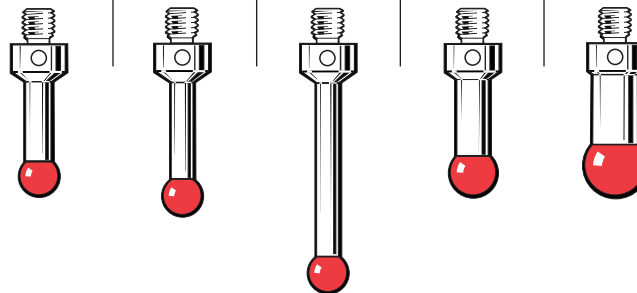

10 mm – 30 mm range

Ruby ball styli (Tungsten carbide stems)

Part number	A-5003-4792	A-5003-2932	A-5003-4793	A-5003-4794	A-5003-4795	A-5003-4796
A Ball dia. mm (in.)	1.0 (0.04)	2.0 (0.08)	3.0 (0.12)	4.0 (0.16)	5.0 (0.20)	6.0 (0.24)
B Length mm (in.)	20.0 (0.79)	20.0 (0.79)	20.0 (0.79)	20.0 (0.79)	20.0 (0.79)	20.0 (0.79)
C Stem dia. mm (in.)	0.7 (0.028)	1.5 (0.06)	2.0 (0.08)	2.0 (0.08)	2.5 (0.10)	2.5 (0.10)
D EWL* mm (in.)	10.0 (0.40)	10.0 (0.40)	8.5 (0.33)	8.5 (0.33)	7.9 (0.31)	10.7 (0.42)
Mass grammes	2.39	3.01	3.53	3.53	4.52	4.66

20 mm range

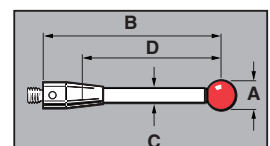
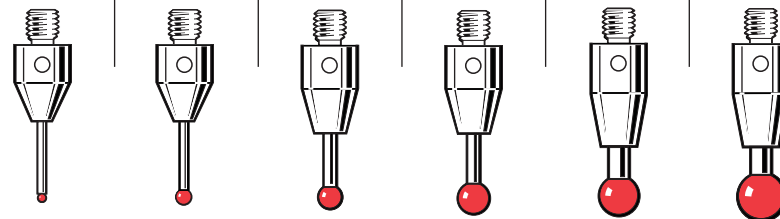

Ruby ball styli

Ceramic stems

Part number		A-5003-0233	A-5003-0235	A-5000-3709	A-5000-7795	A-5003-0236	A-5003-2764	A-5003-4802
		Ceramic	Ceramic	Ceramic	Ceramic	Ceramic	Ceramic	Ceramic
A	Ball dia. mm (in.)	4.0 (0.16)	5.0 (0.20)	6.0 (0.24)	8.0 (0.32)	5.0 (0.20)	6.0 (0.24)	8.0 (0.32)
B	Length mm (in.)	50.0 (1.97)	50.0 (1.97)	50.0 (1.97)	50.0 (1.97)	75.0 (2.96)	75.0 (2.96)	75.0 (2.96)
C	Stem dia. mm (in.)	3.0 (0.12)	3.8 (0.15)	4.5 (0.18)	4.5 (0.18)	3.8 (0.15)	4.5 (0.18)	4.5 (0.18)
D	EWL* mm (in.)	33.5 (1.32)	33.5 (1.32)	38.5 (1.50)	50.0 (1.97)	58.5 (2.30)	63.5 (2.51)	75.0 (2.96)
	Mass grammes	3.9	5.0	4.8	5.4	5.63	5.64	6.20

50 mm – 75 mm range

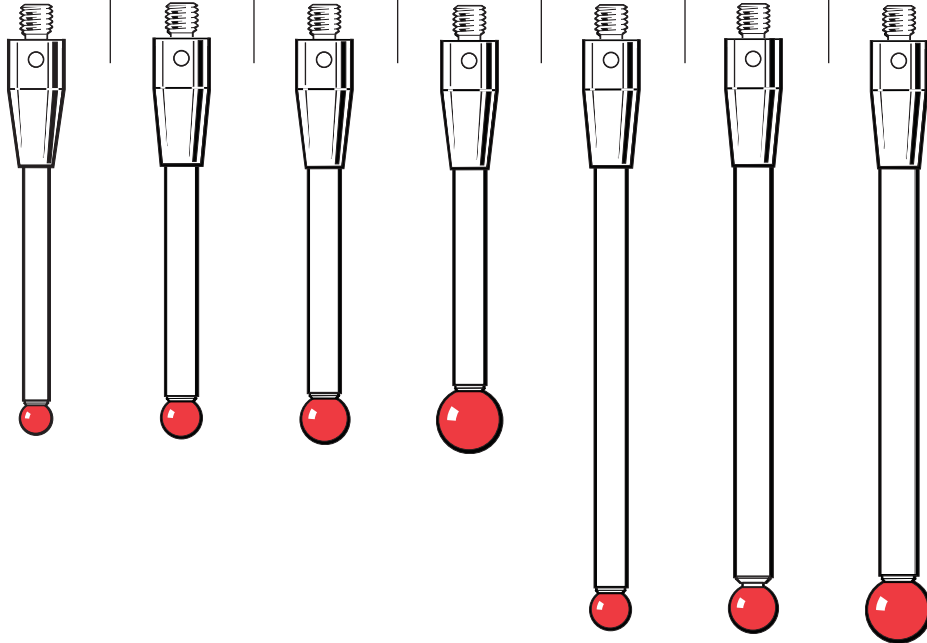

Tungsten carbide stems

Part number		A-5003-4797	A-5003-3680	A-5003-4799	A-5003-4800	A-5003-4801
		Tungsten carbide	Tungsten carbide	Tungsten carbide	Tungsten carbide	Tungsten carbide
A	Ball dia. mm (in.)	2.0 (0.08)	3.0 (0.12)	4.0 (0.16)	5.0 (0.20)	6.0 (0.24)
B	Length mm (in.)	50.0 (1.97)	50.0 (1.97)	50.0 (1.97)	50.0 (1.97)	50.0 (1.97)
C	Stem dia. mm (in.)	1.5 (0.06)	2.0 (0.08)	2.0 (0.08)	2.5 (0.10)	2.5 (0.10)
D	EWL* mm (in.)	40.0 (1.58)	38.5 (1.51)	38.5 (1.51)	37.9 (1.49)	40.7 (1.60)
	Mass grammes	3.80	4.94	4.99	6.72	6.86

50 mm range

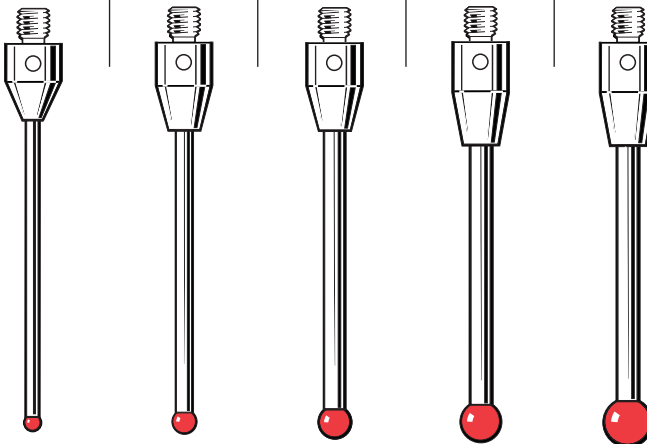

Stainless steel stems

Part number		A-5000-7521
		Stainless steel
A	Ball dia. mm (in.)	5.0 (0.20)
B	Length mm (in.)	50.0 (1.97)
C	Stem dia. mm (in.)	4.5 (0.18)
D	EWL* mm (in.)	33.5 (1.32)
	Mass grammes	5.8

50 mm range

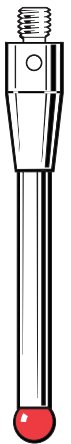

*Effective working length

Ruby ball styli

Part number	A-5000-7522 Stainless steel	A-5000-9761 Ceramic	A-5000-7523 Stainless steel	A-5000-3712 Ceramic	A-5000-8156 Ceramic	A-5000-7796 Ceramic	A-5003-3461 Carbon fibre
A Ball dia. mm (in.)	5.0 (0.20)	5.0 (0.20)	5.0 (0.20)	6.0 (0.24)	6.0 (0.24)	8.0 (0.32)	8.0 (0.32)
B Length mm (in.)	100.0 (3.94)	100.0 (3.94)	150.0 (5.91)	100.0 (3.94)	150.0 (5.91)	100.0 (3.94)	300.0 (11.82)
C Stem dia. mm (in.)	4.5 (0.18)	3.8 (0.15)	4.4 (0.17)	4.5 (0.18)	4.5 (0.18)	4.5 (0.18)	4.5 (0.18)
D EWL* mm (in.)	83.2 (3.28)	83.5 (3.29)	133.0 (5.24)	88.5 (3.48)	135.0 (5.31)	100.0 (3.94)	300.0 (11.82)
Mass grammes	11.3	6.3	17.4	6.3	7.9	7.5	10.4

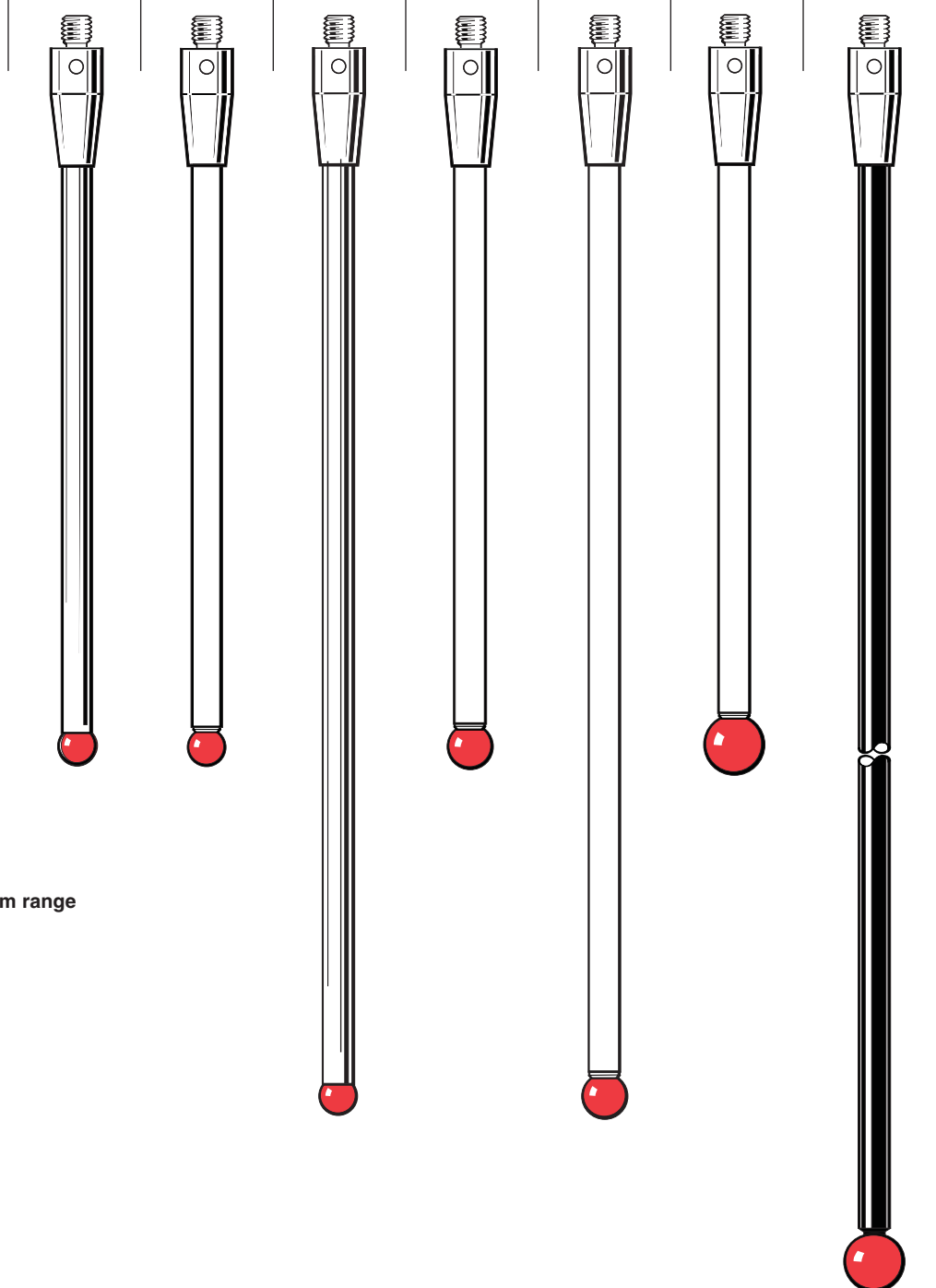

100 mm – 300 mm range

Ruby ball styli
(recommended for use with OMP400 and RMP600)

	Ball material	Part number			
	Ruby	A-5003-7306	A-5003-6510	A-5003-6511	A-5003-6512
	Silicon nitride	A-5003-5730	A-5003-5731		
	Zirconia	A-5003-5744	A-5003-5745		
		Carbon fibre	Carbon fibre	Carbon fibre	Carbon fibre
A	Ball dia. mm (in.)	6.0 (0.24)	6.0 (0.24)	6.0 (0.24)	6.0 (0.24)
B	Length mm (in.)	50.0 (1.97)	100.0 (3.94)	150.0 (5.91)	200.0 (7.88)
C	Stem dia. mm (in.)	4.5 (0.18)	4.5 (0.18)	4.5 (0.18)	4.5 (0.18)
D	EWL* mm (in.)	38.5 (1.52)	88.5 (3.48)	138.5 (5.45)	188.5 (7.42)
	Mass grammes	4.1	6.2	7.5	8.7

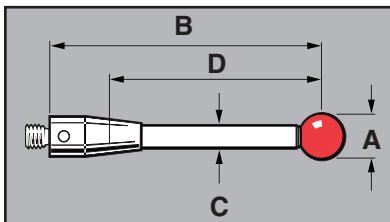
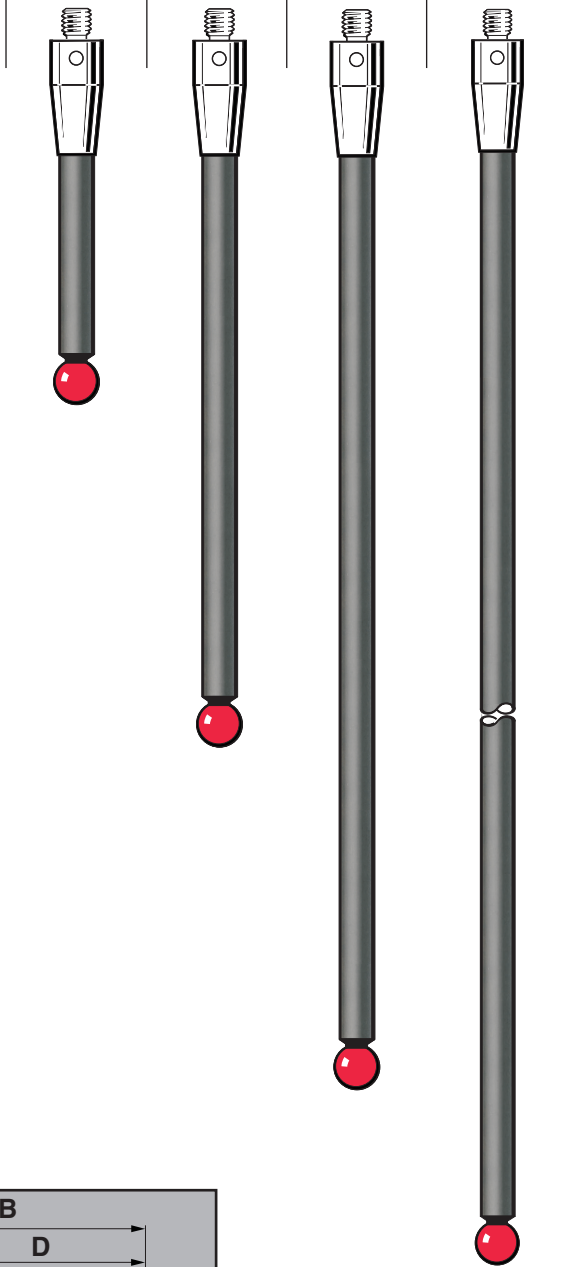

*Effective working length

Ruby ball styli
(recommended for use with MP700)

A-5003-1436**	A-5003-1358**	A-5003-1255**	A-5003-1075**
Carbon fibre	Carbon fibre	Carbon fibre	Carbon fibre
6.0 (0.24)	6.0 (0.24)	6.0 (0.24)	6.0 (0.24)
50.0 (1.97)	100.0 (3.94)	150.0 (5.91)	200.0 (7.88)
4.5 (0.18)	4.5 (0.18)	4.5 (0.18)	4.5 (0.18)
38.5 (1.52)	88.5 (3.48)	138.5 (5.46)	188.5 (7.42)
4.1	6.2	7.5	8.7

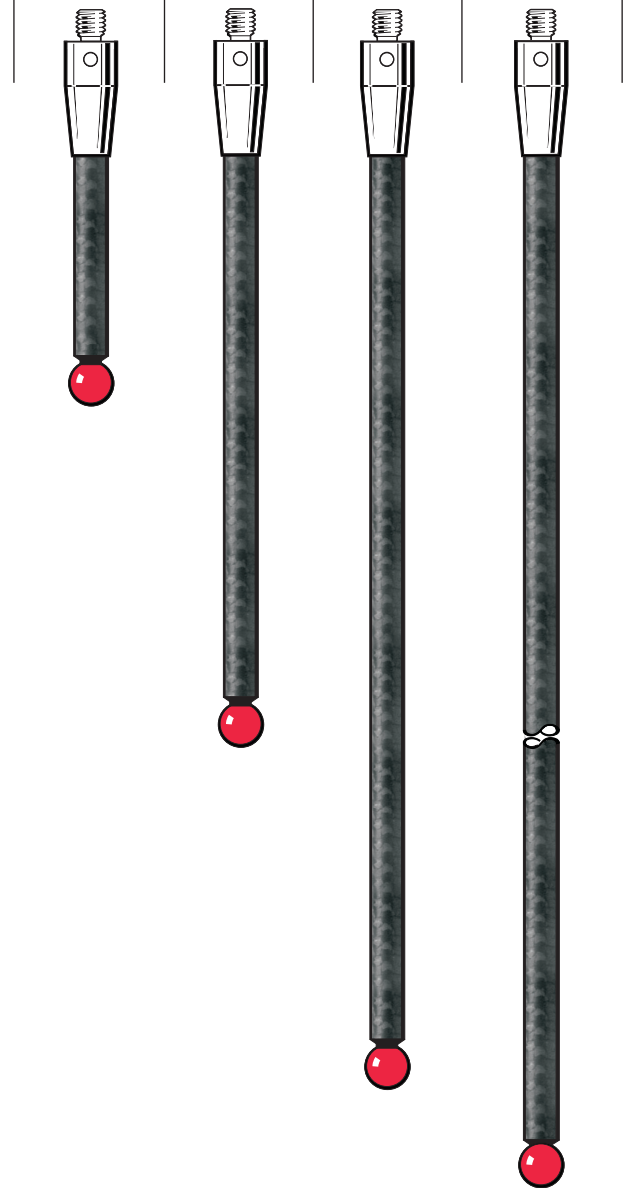

** This MP700 specific stylus has an additional internal design feature that in case of severe overtravel crash allows for a controlled reseating of the probe kinematics avoiding strain gauge damage.

M4 star styli

Ball material	Part number	
Ruby	A-5000-6462	A-5000-7098
A Ball dia. mm (in.)	6.0 (0.24)	6.0 (0.24)
B Length mm (in.)	100.0 (3.94)	50.0 (1.97)
C Stem dia. mm (in.)	4.5 (0.18)	4.5 (0.18)
D EWL* mm (in.)	88.5 (3.48)	38.5 (1.52)
Mass grammes	7.5	6.0

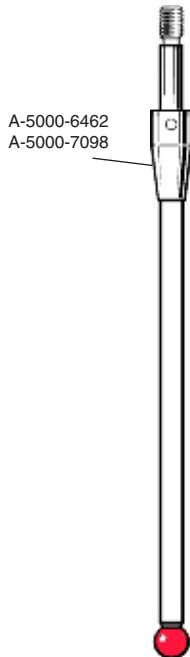
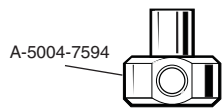

A-5000-6462
A-5000-7098

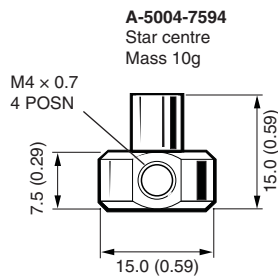

A-5004-7594
Star centre
Mass 10g

Disc styli

Part number	A-5000-7596	A-5000-7597	A-5000-7598
Diameter A mm (in.)	Ø30.0 (1.19)	Ø35.0 (1.38)	Ø50.0 (1.97)
Diameter B mm (in.)	Ø21.0 (0.83)	Ø21.0 (0.83)	Ø23.0 (0.91)
C mm (in.)	2.2 (0.09)	2.2 (0.09)	3.0 (0.12)
D mm (in.)	3.0 (0.12)	3.0 (0.12)	4.0 (0.16)
Mass grammes	8.01	9.57	13.55

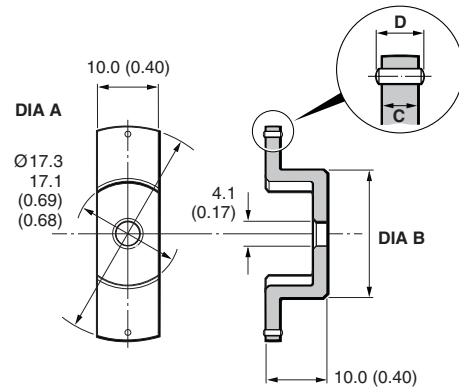

Part number	A-5000-6351
	Silver steel
Disc dia. mm (in.)	Ø30.0 (1.19)
Disc depth mm (in.)	3.0 (0.12)
Length mm (in.)	10.0 (0.40)
Rollers	N/A
Mass grammes	7.9

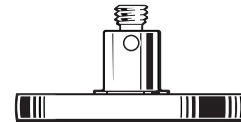

Swivel adaptor

Part number	A-5004-7607	A-5004-7608
Length A mm (in.)	10.0 (0.40)	13.5 (0.54)
Length B mm (in.)	12.5 (0.50)	16.0 (0.63)
Mass grammes	2.76	3.70

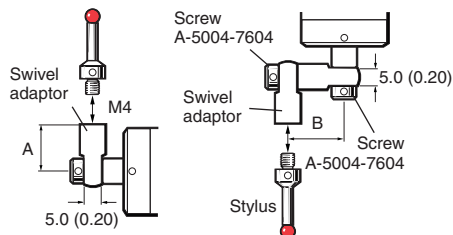

Styli crank

Part number	A-5004-7605	A-5004-7606
Length A mm (in.)	21.9 (0.86)	27.6 (1.09)
Mass grammes	6.07	6.94

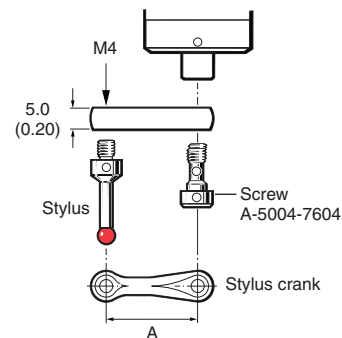

*Effective working length

Sprint styli – M4 thread (ceramic stems)

Part number (standard)	A-5004-4472	A-5004-4474	A-5004-6470	A-5004-6471
Part number (calibrated)	A-5465-8576	A-5465-8577	A-5465-5008	A-5465-5009
Ball material	Ruby	Ruby	Silicon nitride	Silicon nitride
A Ball dia. mm (in.)	6.0 (0.24)	6.0 (0.24)	6.0 (0.24)	6.0 (0.24)
B Length mm (in.)	100.0 (3.94)	150.0 (5.91)	100.0 (3.94)	150.0 (5.91)
C Stem dia. mm (in.)	3.8 (0.15)	3.8 (0.15)	3.8 (0.15)	3.8 (0.15)
D ESWL* mm (in.)	62.9 (2.48)	71.5 (2.81)	62.9 (2.48)	71.5 (2.81)
Mass grammes	6.5	8.0	6.5	8.0

* ESWL = Effective Scanning Working Length, measured from the centre of the ball to the point at which the stem will foul against a vertical face when at the maximum scanning deflection.

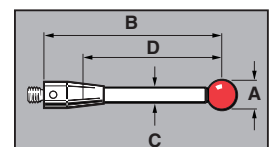
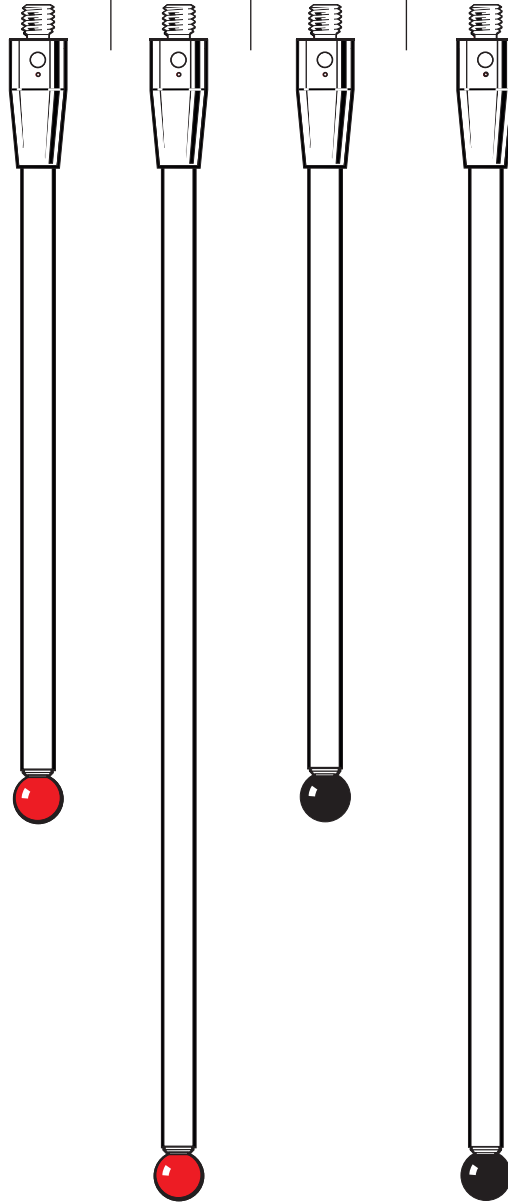

Sprint styli continued
M4 thread (ceramic stems)

Part number (standard)		A-5004-6463	A-5004-6464	A-5004-6465	A-5004-6467	A-5004-6468	A-5004-6469
Part number (calibrated)		A-5465-5001	A-5465-5002	A-5465-5003	A-5465-5005	A-5465-5006	A-5465-5007
Ball material		Ruby	Ruby	Ruby	Silicon nitride	Silicon nitride	Silicon nitride
A	Ball diameter mm (inch)	2.0 (0.08)	3.0 (0.12)	4.0 (0.16)	2.0 (0.08)	3.0 (0.12)	4.0 (0.16)
B	Length mm (inch)	80.0 (3.15)	100.0 (3.94)	100.0 (3.94)	80.0 (3.15)	100.0 (3.94)	100.0 (3.94)
C	Stem diameter mm (inch)	1.5 (0.06)	2.0 (0.08)	2.0 (0.08)	1.5 (0.06)	2.0 (0.08)	2.0 (0.08)
D	ESWL* mm (inch)	10.7 (0.42)	27.0 (1.06)	42.6 (1.68)	10.7 (0.42)	27.0 (1.06)	42.6 (1.68)
E	Stem diameter mm (inch)	3.8 (0.15)	3.8 (0.15)	3.8 (0.15)	3.8 (0.15)	3.8 (0.15)	3.8 (0.15)
	Mass (grammes)	5.9	7.4	7.4	5.9	7.4	7.4

* ESWL = Effective Scanning Working Length, measured from the centre of the ball to the point at which the stem will foul against a vertical face when at the maximum scanning deflection.

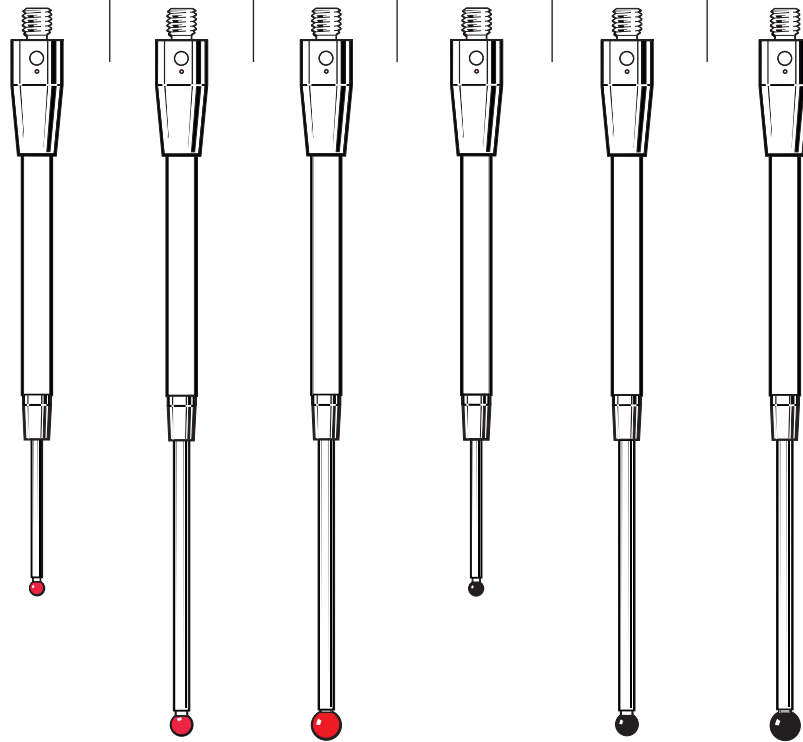

M4 threaded stylus range
1.7

SPRINT standard range

During scanning the stylus is constantly deflected, so the ceramic stem has been designed to be narrow and therefore tightly control all squareness tolerances. This ensures that even when measuring a part with vertical surfaces, such as on prismatic parts, the risk of the stylus shank contacting the part before the stylus tip is minimised.



SPRINT calibrated range

In the variable temperature environment typical of a machine tool, the dimensional variation of the calibration sphere, compared with the machine structure, can degrade the performance of the measurement system. In the highest accuracy applications, this contribution to the overall system measurement uncertainty can be significant.

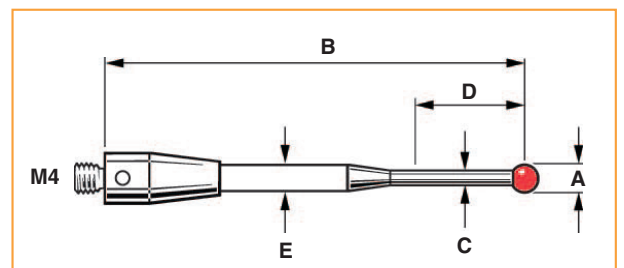

To ensure the highest possible measurement accuracy in all measurement conditions, the ball on each stylus within the SPRINT calibrated range is measured and UKAS certified. The exact ball diameter is engraved onto the stylus holder, so that this highly accurate value can be applied during probe calibration as an absolute reference.

Primo toolsetter stylus

Part number		A-5472-3000
		Tungsten carbide
Ruby		
Silicon nitride		
Zirconia		
A	Disc dia. mm (in.)	26 (1.02)
B	Disc depth mm (in.)	4 (0.16)
C	Length A mm (in.)	11 (0.43)
D	Length B mm (in.)	31 (1.22)
	Mass grammes	34

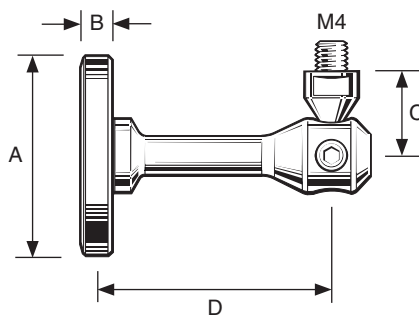







Flat bottom cylinder stylus (tungsten carbide)

Part number	A-5004-5370 Tungsten carbide
Cylinder dia. mm (in.)	1.0 (0.04)
Overall length mm (in.)	20.0 (0.79)
EWL mm (in.)	10.0 (0.40)
Mass grammes	2.5







This flat-bottomed stylus has been specifically designed for xy and accurate z point measurement with the face being precision ground parallel.

Crash protection devices

Part number For pack of ten	A-5004-7598	A-5004-7603	A-5004-7604	A-5004-7621	A-5003-0661* A-5004-1865	A-5004-7624 A-5004-1867	A-5004-6723 A-5004-1869
	Stainless steel	Stainless steel	Stainless steel	Silver steel	Silver steel	Silver steel	Silver steel
Length mm (in.)	8.0 (0.32)	8.0 (0.32)	10.0 (0.40)	12.0 (0.48)	15.2 (0.60)	9.0 (0.36)	16.0 (0.63)
Mass grammes	1.8	1.4	1.5	2.7	4.6	1.5	2.1
For use on	LP2	LP2	LP2	MP10 MP12 RMP60 OMP60 MP3 MP11	TS27R	HPMA HPRA HPPA	HPMA HPRA HPPA
							

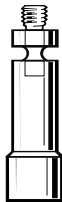
Use **P-TL09-0003**
to tighten.

* Please note: If you require the full TS27R break stem kit, please order A-5003-5171.

Part number	A-5004-7616 M3 Silver steel	A-5004-7618 M3 Silver steel	A-5004-7619 M3 Silver steel	A-5004-7620 M4 Silver steel	A-5004-7622 M4 Silver steel
Length mm (in.)	13.3 (0.52)	22.3 (0.88)	30.3 (1.19)	13.5 (0.53)	19.0 (0.75)
Mass grammes	2.43	3.6	4.5	1.37	2.2
For use on	TS20	TS20	TS20	RP1/2	TSA
					

Cranked styli

Part number	A-5000-5302 M4 Stainless steel	A-5000-5307 M4 Stainless steel	A-5000-6620 M4 Stainless steel	A-5000-7580 M4 Stainless steel
Length L1 mm (in.)	32.0 (1.26)	20.1 (0.79)	27.4 (1.08)	38.8 (1.53)
Length L2 mm (in.)	21.9 (0.86)	34.9 (1.37)	19.0 (0.75)	12.5 (0.49)
Mass grammes	3.8	3.85	4.7	2.5
For use on	LP2	LP2	LP2	LP2

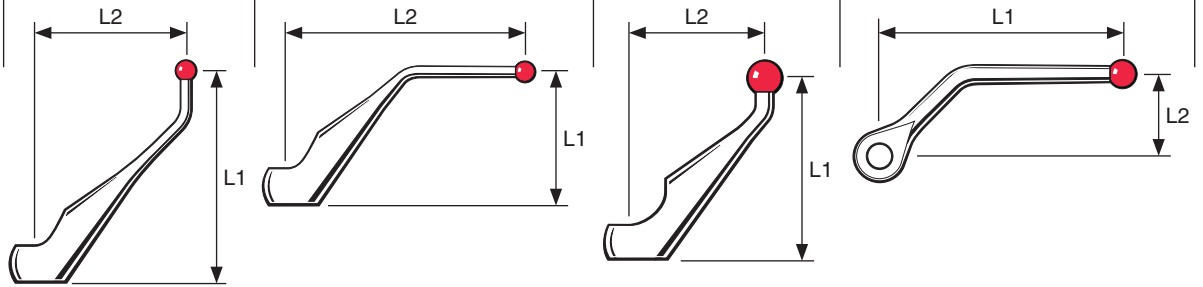

Tool datuming styli

Part number	A-5000-3212* Stainless steel	A-5000-6701* Stainless steel	A-5000-6713 Aluminium	A-5000-6403 Stainless steel
Overall length mm (in.)	53.0 (2.09)	43.0 (1.70)	96.5 (3.80)	32.5 (1.28)
Stem dia. mm (in.)	4.5 (0.18)	4.5 (0.18)	7.5 (0.30)	5.4 (0.22)
Mass grammes	4.5	4.3	21.9	11.0

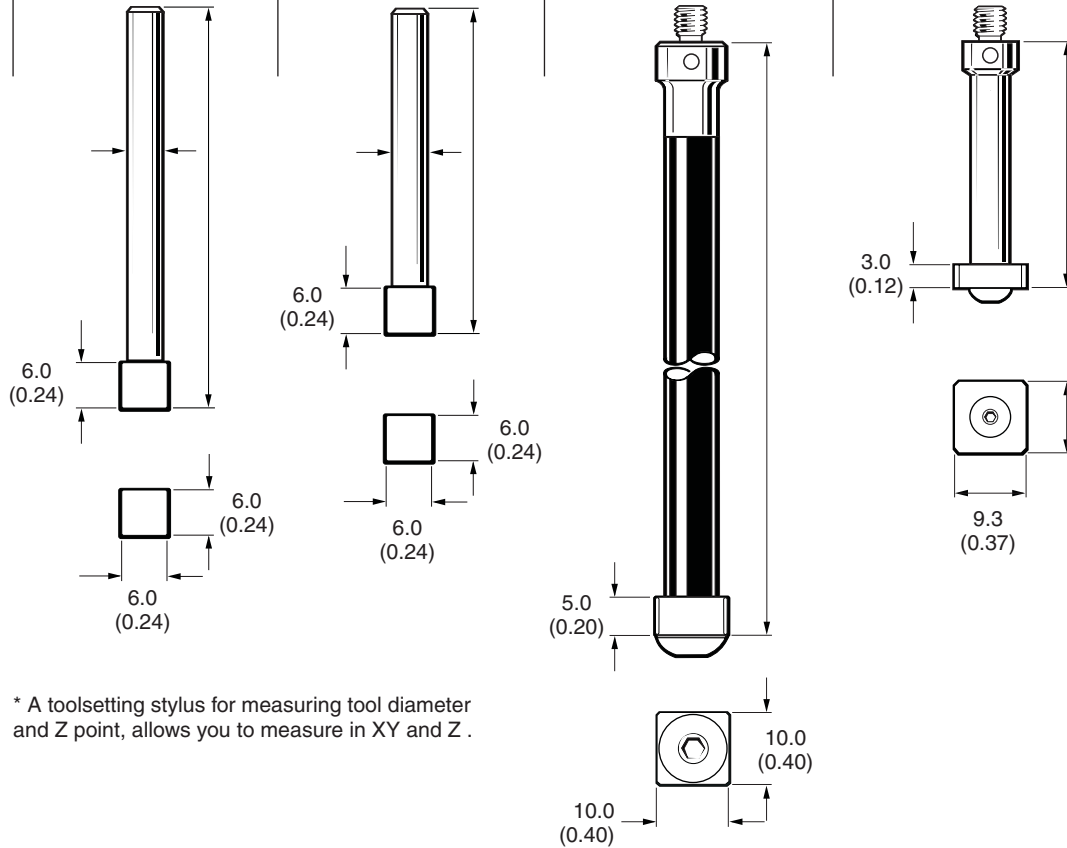

* A toolsetting stylus for measuring tool diameter and Z point, allows you to measure in XY and Z .

Part number	A-2116-0142
Length mm (in.)	30.3 (0.40)
Mass grammes	22.6
For use on	TSA

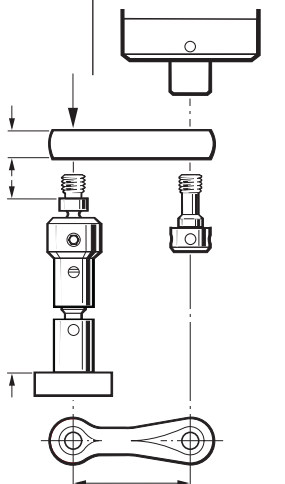

Tool datuming styli (continued)

Part number	A-2197-0157 Tungsten carbide	A-2197-0158 Tungsten carbide	A-2197-0159 Tungsten carbide	A-2197-0160 Tungsten carbide	A-2197-0161 Tungsten carbide	A-2197-0162 Tungsten carbide
Length mm (in.)	14.2 (0.56)	19.57 (0.77)	29.5 (1.16)	34.5 (1.36)	39.5 (1.55)	49.5 (1.95)
Mass grammes	14.86	16.0	20.0	20.7	21.8	23.5
For use on	HPPA	HPPA	HPPA	HPPA	HPPA	HPPA
	HPMA	HPMA	HPMA	HPMA	HPMA	HPMA
	HPRA	HPRA	HPRA	HPRA	HPRA	HPRA
	RP3	RP3	RP3	RP3	RP3	RP3
Replacement break stem	A-5004-7624	A-5004-7624	A-5004-7623	A-5004-7623	A-5004-7623	A-5004-7623

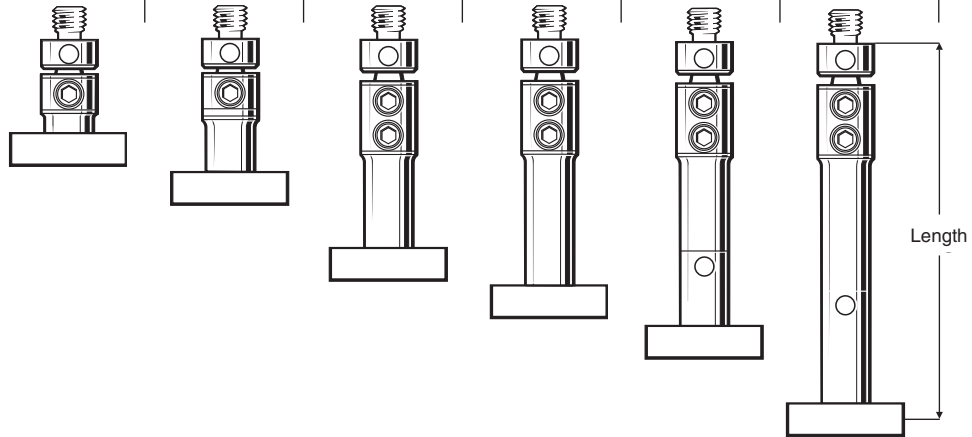

Part number	A-2008-0601 M3 Tungsten carbide	A-2008-0602 M3 Tungsten carbide	A-2008-0603 M3 Tungsten carbide	A-2048-2050 M4 Tungsten carbide	A-2048-2051 M4 Tungsten carbide	A-2116-0140 M4 Tungsten carbide	A-2116-0141 M4 Tungsten carbide
Length mm (in.)	15.4 (0.61)	24.0 (0.96)	32.4 (1.27)	23.2 (0.91)	32.0 (1.26)	32.0 (1.26)	42.0 (1.65)
Mass grammes	9.1	8.0	8.95	18.14	20.64	13.56	16.05
For use on	TS20	TS20	TS20	HPA (M6 MTG)	HPA (M6 MTG)	TSA	TSA
Replacement break stem	A-5004-7616	A-5004-7618	A-5004-7619	A-5004-7620	A-5004-7620	A-5004-7620	A-5004-7620

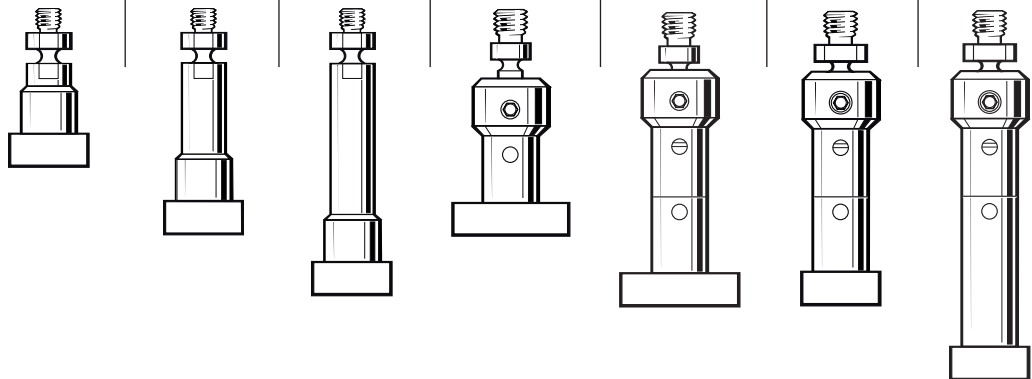

TS27R styli

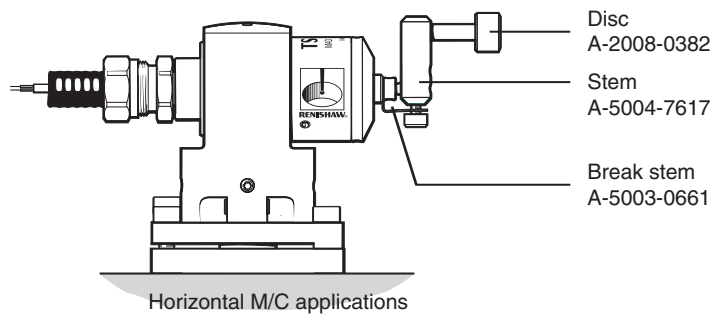
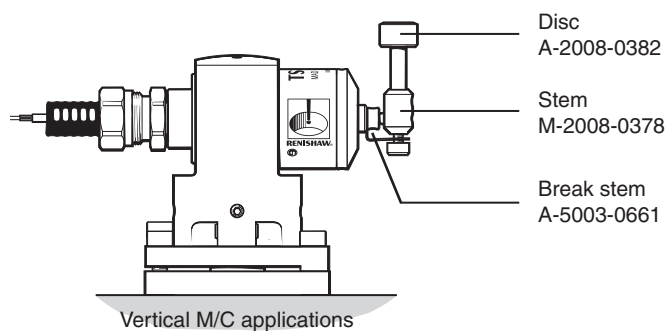

Horizontal machine application conversion
kit part number A-2008-0448

*Order also requires 2 x P-SC11-0404

TS27R styli – parallel shafted (not M4) – Not compatible with TS27 probes

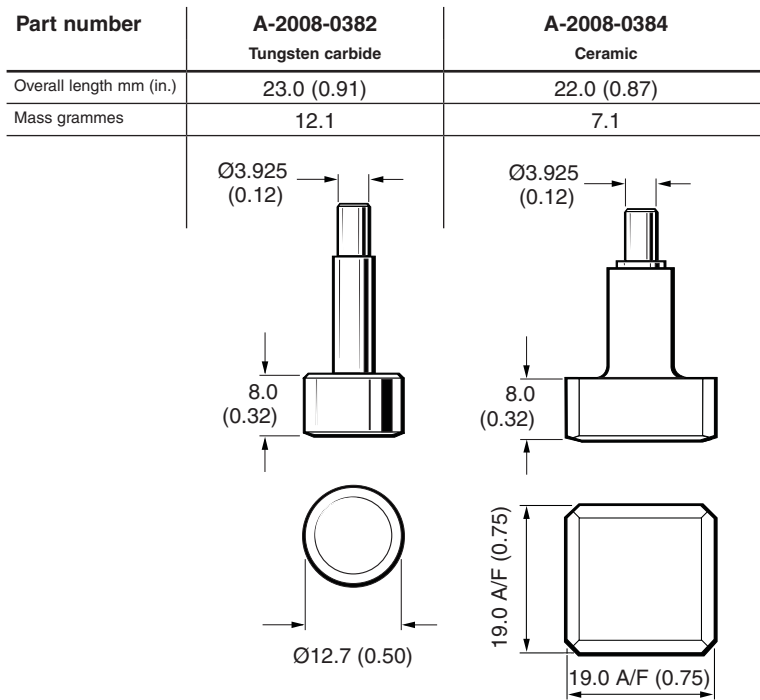

Stylus extensions

Part number	A-5004-7599 Stainless steel	A-5004-7600 Stainless steel	A-5004-7601 Stainless steel	A-5004-7602 Stainless steel	A-5000-7754 Ceramic	A-5000-7755 Ceramic	A-5000-7727 Ceramic	A-5003-0587 Ceramic
Length mm (in.)	10.0 (0.40)	15.0 (0.60)	20.0 (0.79)	30.0 (1.19)	30.0 (1.19)	50.0 (1.97)	100.0 (3.94)	200.0 (7.87)
Stem dia. mm (in.)	7.0 (0.28)	7.0 (0.28)	7.0 (0.28)	7.0 (0.28)	7.4 (0.30)	7.4 (0.30)	7.4 (0.30)	7.4 (0.30)
Mass grammes	2.4	3.7	4.8	7.4	5.1	6.7	10.6	18.4

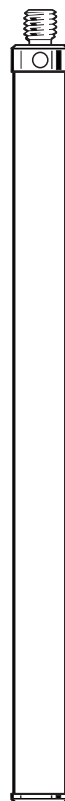
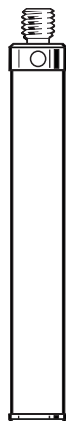
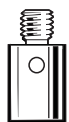

M4 threaded stylus range
1.15

Tungsten carbide styli (stainless steel stems)

Part number	A-5000-7670	A-5000-7671	A-5000-7672	A-5000-9685	A-5000-9697
A Ball dia. mm (in.)	5.0 (0.20)	5.0 (0.20)	5.0 (0.20)	5.0 (0.20)	3.0 (0.12)
B Length mm (in.)	50.0 (1.97)	100.0 (3.94)	150.0 (5.91)	54.0 (2.12)	55.0 (2.17)
C Stem dia. mm (in.)	4.5 (0.18)	4.5 (0.18)	4.5 (0.18)	3.9 (0.15)	1.9 (0.07)
D EWL* mm (in.)	35.0 (1.38)	85.0 (3.35)	135.0 (5.31)	50.0 (1.97)	25.0 (0.99)
Mass grammes	6.2	11.9	18.2	6.9	3.8

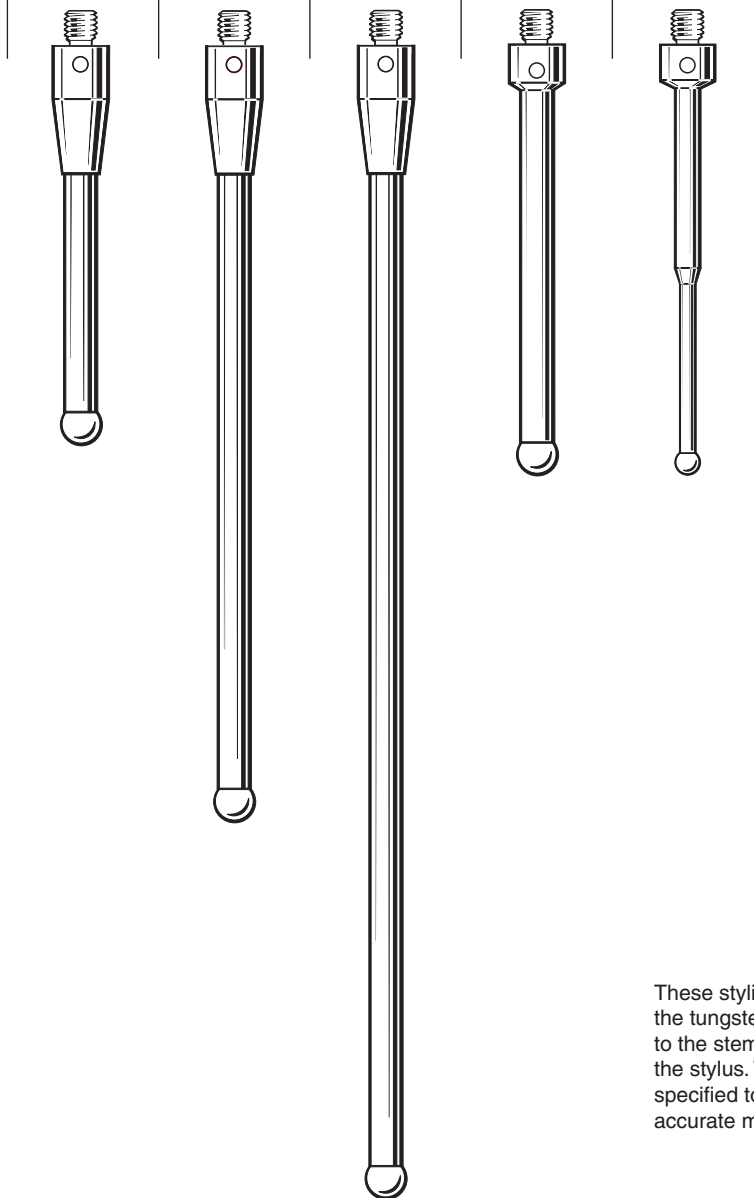

These styli are for use on job contact probes; the tungsten carbide balls have been brazed to the stem to ensure conductivity through the stylus. The resistance of these styli are specified to be less than 0.1 Ω to ensure accurate measurement with your probe.

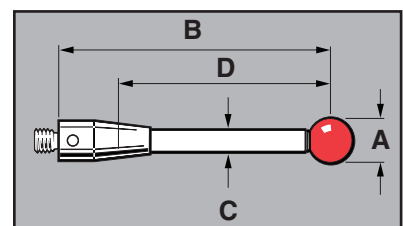

*Effective working length

About Renishaw

Renishaw is an established world leader in engineering technologies, with a strong history of innovation in product development and manufacturing. Since its formation in 1973, the company has supplied leading-edge products that increase process productivity, improve product quality and deliver cost-effective automation solutions.

A worldwide network of subsidiary companies and distributors provides exceptional service and support for its customers.

Products include:

- Additive manufacturing and vacuum casting technologies for design, prototyping, and production applications
- Dental CAD/CAM scanning systems and supply of dental structures
- Encoder systems for high-accuracy linear, angle and rotary position feedback
- Fixturing for CMMs (co-ordinate measuring machines) and gauging systems
- Gauging systems for comparative measurement of machined parts
- High-speed laser measurement and surveying systems for use in extreme environments
- Laser and ballbar systems for performance measurement and calibration of machines
- Medical devices for neurosurgical applications
- Probe systems and software for job set-up, tool setting and inspection on CNC machine tools
- Raman spectroscopy systems for non-destructive material analysis
- Sensor systems and software for measurement on CMMs
- Styli for CMM and machine tool probe applications

For worldwide contact details, visit www.renishaw.com/contact



RENISHAW HAS MADE CONSIDERABLE EFFORTS TO ENSURE THE CONTENT OF THIS DOCUMENT IS CORRECT AT THE DATE OF PUBLICATION BUT MAKES NO WARRANTIES OR REPRESENTATIONS REGARDING THE CONTENT. RENISHAW EXCLUDES LIABILITY, HOWSOEVER ARISING, FOR ANY INACCURACIES IN THIS DOCUMENT.

© 2012–2016 Renishaw plc. All rights reserved.

Renishaw reserves the right to change specifications without notice.

RENISHAW and the probe symbol used in the RENISHAW logo are registered trade marks of Renishaw plc in the United Kingdom and other countries. apply innovation and names and designations of other Renishaw products and technologies are trade marks of Renishaw plc or its subsidiaries. All other brand names and product names used in this document are trade names, trade marks or registered trade marks of their respective owners.



H - 1000 - 7549 - 02

Part no.: H-1000-7549-02-A
Issued: 01.2016