

# machflow<sup>®</sup>



- Ultra-fast drying time
- Minimum energy consumption
- Minimum CO<sub>2</sub> emissions
- Minimum noise pollution
- Adjustable High Speed motor: turn up for fast drying; turn down for quiet operation
- Rock solid & Compact Design
- ADA recessed kit available
- GreenSpec listed

To download technical data sheets, 3 CSI Specs, CADs, BIM and Green Info, please go to [www.saniflowcorp.com](http://www.saniflowcorp.com) or visit your preferred specification website:

[Sweets.com](http://Sweets.com) [BIM](#) [CAD](#) [Specs](#) [Green](#)



[4specs.com](http://4specs.com) [BIM](#) [CAD](#) [Specs](#) [LEED](#)





**HIGH SPEED**



### **A ROCK SOLID & COMPACT DESIGN**

Our most powerful & energy efficient high speed hand dryer incorporates a low energy, high pressure, adjustable motor that allows you to choose noise levels between 68 to 75db, cuts and drying times to 10 to 15 seconds and utilizes an incredibly energy efficient 6.4 amps per drying cycle drawing a min of 450 watts instead of the usual 2300 Watts.

## HAND DRYERS

**machflow®**

### **Who is using MACHFLOW M09A Hand dryers:**

- Northwestern University, Kellogs Dorms, Chicago, IL
- Citrus College Football Stadium, Glendora, CA
- Downing University Center, Western Kentucky University, Bowling Green, KY
- Pennsylvania State University, Residential Housing, PA
- Glendale Community College, Glendale, CA
- North Myrtle Beach Park & Sport Complex, SC
- Old Pueblo Gymnastic Academy, Tucson, AZ
- Tegeler High School, Pasadena, TX
- City of SouthPort Public Works, SouthPort, NC
- City of Gridley, KS
- Main Lodge Custodial, Mammoth Lakes, CA
- Vittoria Caffè, Boston, MA



sensor operated

Legend for symbols shown on last page of catalog

### M09A

material: steel  
finish: white epoxy

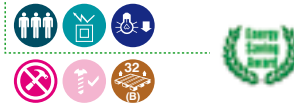

### M09AB

material: steel  
finish: black epoxy

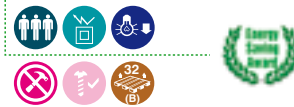

### M09AC

material: AISI 304 stainless steel  
finish: bright

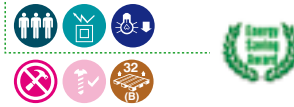

### M09ACS

material: AISI 304 stainless steel  
finish: satin

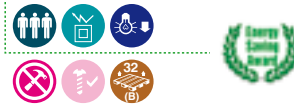

#### M09A · M09AB · M09AC · M09ACS | | | COMPONENTS AND MATERIALS

- Maximum airspeed: 203 mph.
- One piece cover 1/16" thick.
- The ABS-PC base includes silent-blocks to damp mechanical vibrations.
- Class F high pressure Universal brush motor.
- Internal UL plastic housing components to be flame retardant type.
- Automatic disconnection system after 60 seconds of continuous use.
- Minimum hearing element (only 250 W).
- Fully adjustable (2"-8") infrared electronic detection sensor by means of a potentiometer.
- Lower power consumption: motor works at an adjustable 450-1.300 Watts.
- Sensors come with a vandal-resistant polycarbonate viewing window.
- GreenSpec® approved & offering LEED Credits.

#### M09A · M09AB · M09AC · M09ACS | | | TECHNICAL SPECIFICATIONS

Estimated drying time	10-15 seconds	Total Power	450 – 1300 W
Voltage	100-120 V	Heating Element	50 – 250 W
Frequency	50/60 Hz	Protection level	IP23
Power Consumption	6.4 – 10 Amps (120 V)	Nominal airflow	76 – 116 CFM
Electrical insulation	Clase I (ground required)	Effective airflow	68 – 108 CFM
Motor Power	400 – 1050 W	Air temp (at 4" distance/70°F)	107.6°F (42°C)
rpm	adjustable (18.000 – 26.000 rpm)	Dimensions	8 3/8" x 13" x 6 11/16"
Air speed	134 – 203 mph / 11.800 – 18.000 LFM	Weight	8.81 Lbs. (4.7 kg)
		Noise level	68 – 75 dB

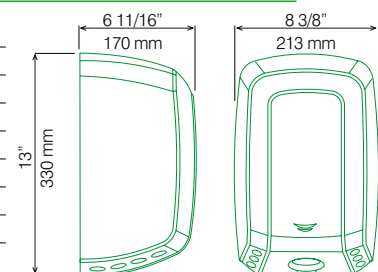

# ADA RECESSED KIT

**machflow**<sup>®</sup>  
(Does not include Hand dryer)

## ACCESSIBILITY & ADA

The American Disabilities Act (ADA) was passed in 1990. Basically, It provides civil rights protections to people with disabilities, ensuring equal access to all public goods and services. This resulted in ADA standards and guidelines for accessibility to places of public accommodations and commercial facilities by individuals with disabilities.

### How does ADA apply to hand dryers?

There are not any specific references to hand dryers in the regulations, but there are regulations pertaining to turning radius (for wheelchairs to have enough room) and objects that protrude from the wall.

In fact, for most public bathrooms, to be ADA compliant (American Disabilities Act), a hand dryer (with leading edges between 27 and 80 inches) that is located in a passage way must protrude less than 4" from the wall (so, that a person using a walking stick will not bump into it). If the hand dryer is not thin enough, a recess wall box will be needed to reduce the depth of the dryer to less than 4 inches., complying with the ADA standards.

Here ´s exactly what the regulation says:

*307.2 Protrusion limits: Objects with leading edges more than 27 inches (685 mm) and not more than 80 inches (2030 mm) above the finish floor or ground shall protrude 4 inches (100 mm) maximum horizontally into the circulation path.*

The American with Dissabilities Act (ADA) defines the accessible requirements for the design and construction of washroom spaces in the USA.

The machflow<sup>®</sup> has been designed to comply with these recommendations. As you can see on these examples of installations:

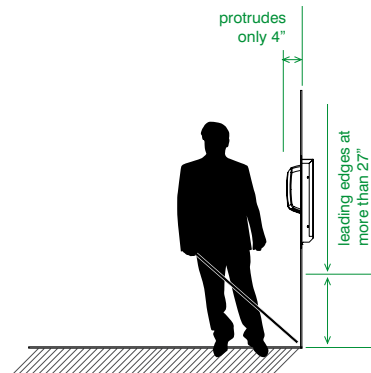

## KT009CS

Material: AISI 304 stainless steel  
Finish: satin



dryer not included

### KT009CS | MATERIALS & DIMENSIONS

With 4 screws holes of 23/64 (9 mm) for mounting on the wall.

- Weight:** 6.6 lbs. (3 Kg.)
- Overall Dimensions:** 14 3/4" wide x 23 7/16" high x 3 1/16" deep (375 mm wide x 595 mm high x 77 mm deep)
- Rough Wall Opening:** 13" wide x 21 11/16" high x 3 1/16" deep (330 mm wide x 550 mm high x 77 mm deep)
- Construction:** Wall box is fabricated of 2 welded pieces. The dryer mounting area is fabricated of 18 GA 18-8 type 304 stainless steel, and frame is fabricated of 22 GA 18-8 type 304 stainless.
- Installation Guide:** When installed bottom of hand dryer will be 7 1/2" (190 mm) above bottom of rough wall opening.

Consult local ADA codes

### KT009CS | TECHNICAL SPECIFICATIONS

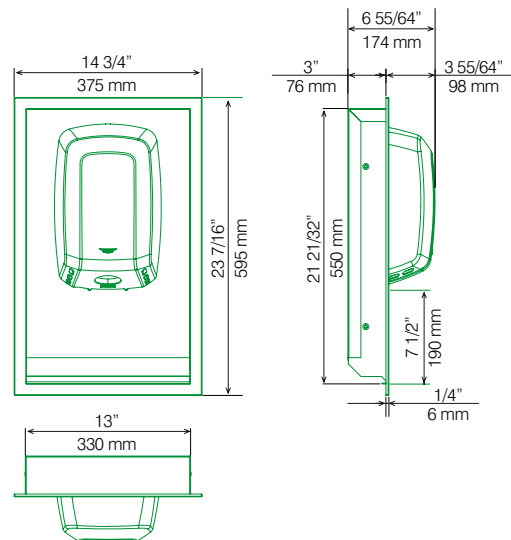

saniflow corp.





# SANIFLOW Corp.

## The company behind the technology

### A Track Record of Excellence

Saniflow Hand Dryer Corp. has established itself as one of North America's leading brands of eco-friendly hand-drying solutions. We offer **the largest selection of fast, stylish, and energy-efficient products**, designed to fit every type of washroom facility.

Our company works with design professionals, contractors, owners, and facility managers to ensure that every project gets the right dryers for its needs. **Our products are in use in highly recognizable office buildings, entertainment centers, shopping facilities, schools and universities throughout North America.**

Saniflow hand dryers benefit from **40 years of manufacturing experience** and expertise by our parent company, **Mediclinics S.A., the largest exporter of hand dryers in the world** and a leader in the European and global markets. Dryers produced in our manufacturing facility in Barcelona, Spain, **are used in over 120 countries worldwide.** Quality is assured through every step of the manufacturing process, and each dryer is tested and approved before shipping.

### Commitment to Our Customers

We stand behind our products, and consider every sale as the beginning of a customer service relationship. Under our **Quick Ship Program**, applicable to all distribution channels, all products listed in our catalog ship within 36 hours (under normal circumstances) on purchase orders from distributors that have established credit terms with Saniflow. Our team of customer satisfaction professionals is available to answer any product questions and **offer full technical support.**

### Responsible Manufacturing

We are equally committed to sustainability in operations. We use a **combination of new and recycled materials**, many of them also recyclable, and have instituted advanced waste stream separation in manufacturing.



# High-Speed Dryers

## The Greenest Solution

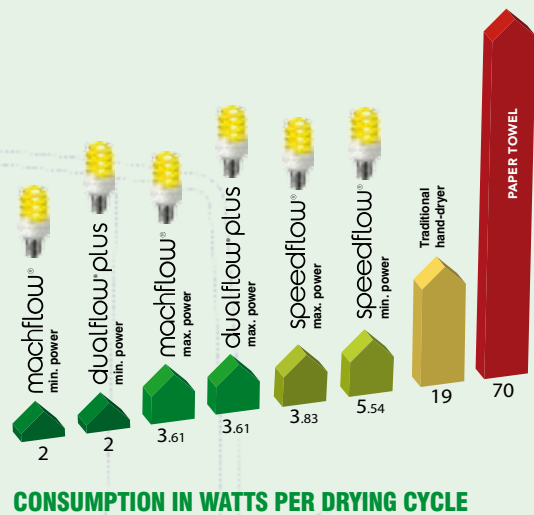

## The Future

Sustainability in construction, renovation, and operation are becoming the new normal. Saniflow high-speed hand dryers are contributing to this movement by offering the largest selection of Green Spec certified and LEED point contributing hand dryers of any manufacturer anywhere, helping achieve energy-efficiency and waste-reduction targets set by owners or mandated by code.

- Eliminating paper towels can reduce non-recycled waste by 5 - 15% in many establishments.
- High-speed dryers reduce energy consumption vs. paper towels or traditional dryers.
- High-speed dryers reduce heat emissions vs. traditional dryers.

## A leader in Sustainability

Saniflow's high-speed models feature advanced design that lowers environmental impacts compared to competitive products. We have optimized airflow performance and motor design to deliver fast drying (10-15 seconds) at lower power consumption. We have reduced generated noise levels, an important environmental factor in any occupied facility, and introduced machines that can be speed-customized to fine tune noise and power consumption.

- Machflow, Dualflow Plus and Speedflow dryers can reduce energy consumption by as much as 90% over traditional dryers.
- Machflow, Dualflow Plus and Speedflow dryers can consume less than 3% of the energy per drying cycle used by paper towels.
- Saniflow green models produce one of the industry's lowest heat emissions.
- Saniflow is a leader in quieter dryers, achieving a low 65 dB for our high-speed dryers.
- GreenSpec listed.
- UL, CUL & CE listed.

Our eco-friendly high-speed range are perfect choices for achieving sustainability goals – contributing to points for LEED credits and Green Spec certifications – in new buildings, renovation projects, and sustainability upgrades. Schools and universities, offices, hotels, restaurants, and other facilities with high restroom traffic can benefit significantly from this new generation of hand dryers.

## Corporate Core Values

Respect for the environment is a core value at Saniflow. Materials used in manufacture –including a significant proportion of recycled materials– are chosen not only for high quality, but also for the lowest possible impact on human beings and the planet. Much of our products' contents are recyclable at the end of service life. In fact, they comply with the stringent European WEEE Directive (Waste Electronic and Electrical Equipment). Our manufacturing operations also include a thorough waste separation scheme.

## The Green Discount

Saniflow high-speed hand dryers reduce operating costs drastically, by as much as 90% of drying costs as compared to paper towels.

- Reduced energy consumption.
- Reduced maintenance costs.
- Reduced waste disposal costs.
- Eliminated supply costs.

Saniflow Hand Dryers offer performance, reliability, durability and style in products engineered to respect and protect the environment. This combination of top quality and sustainable responsibility has made us a worldwide market leader.



# NORTH AMERICAN REFERENCES

## U.S.A. & CANADA

### UNIVERSITIES:

- Rutgers University, Piscataway, NJ
- University of Rochester, Rochester, NY
- Northwestern Kellogs University, Chicago, IL
- State University College, NY
- Pacific University, OR
- Savannah State University, Savannah, GA
- Texas Tech University, TX
- Pennsylvania State University - Residential Housing, PA
- San Diego State University, San Diego, CA
- Flagstaff Union University, Flagstaff, AZ
- Central Michigan University, Mount Pleasant, MI
- University of Notre Dame, IN
- Berkley College, Woodland Park, NJ
- University of California - Berkeley, Vance Brown Bldg., CA
- State University College, NYC, NY
- Texas Tech University, Lubbock, TX
- University of Notre Dame, Notre Dame, IN
- Madison College, Madison, WI

### SCHOOLS:

- Dallas-Ft. Worth school district, TX
- Chula Vista school district, CA
- San Jose City College, San Jose, CA
- Dan D. Rogers elementary school, Dallas, TX
- Duluth High School, Wood Land Hills Academy, Duluth, MN
- Rivers Middle School, Charleston, S.C.
- Justin Siena High School, Napa, CA
- York College of Pennsylvania, PA
- Troy Shorewood Elementary School, Shorewood, IL
- Appleton city school district, Appleton City, MO
- Magnolia school district, Jefferson, LA
- Aquinas Montessori school, VA
- Moorpark Unified school district, Moorpark, CA
- Tumwater High school, Tumwater, WA
- The Town School, NYC, NY
- Valley Christian Child Care Center, Saint Clairville, OH
- Ecole Polymechanique, Laval, Quebec, Canada
- Academie Ste. Therese, Rosemere, Quebec, Canada
- Aquinas Montessori School, Alexandria, VA

### SHOPPING CENTERS:

- Round Rock Prem Outlet Mall, Round Rock, TX
- Denver Pavilions Moll, Denver, CO
- West Hawaii civic center, Hilo, HI
- Chinook shopping Center, Calgary, Alberta, Canada
- Fairview park Mall, Kitchener, Ontario, Canada
- Polo Park shopping Center, Winnepeg, Manitoba, Canada

### HOSPITALS:

- Mendota Mental Health Institution, Madison, WI
- IHC Hospital, Sant Lake City, UT
- Fresenius medical Center, Pharr, TX
- Bingham memorial hospital, Blackfoot, ID
- Cano Medical Center, Pembroke Pines, FL
- Conyers Medical Clinic, Conyers, GA
- Curious Mind Child Development Center, Washington D.C.
- Riverside Pediatric Hospital, Newbury Port, MA
- South Lake Hospital, Clermont, FL

### STADIUMS & MOVIE THEATERS:

- Dodger Stadium, Los Angeles, CA
- Delaware State Fairgrounds, Harrington, DE
- Brewer H.S. Stadium, Fort Worth, TX
- Cinemark movie theaters, nationwide
- Century movie theaters, nationwide

### LIBRARIES & MUSEUMS:

- Brooklyn Children's Museum, Brooklyn, NY
- Neshoba County public library, Philadelphia, MS
- Ann Arbor Library, Ann Arbor, MI
- Austin Hill Country Galleria, Bee Cave, TX
- Jefferson Davis Home & President Library, Biloxi, MS

## More than a decade drying your hands

### AIRPORTS:

- United Airlines VIP red carpet Clubs, nationwide
- JFK International Airport New York, NY
- U.S. El Segundo air force airport, El Segundo, CA
- U.S. Army Norfolk air force airport, Norfolk, VA
- Schole international airport, Galveston, TX
- San Juan International airport, San Juan, PR

### STORES:

- Wal Mart Stores & Superstores, nationwide
- Abercrombie & Fitch (Hollister Stores), national & international
- GAP Store, Denver Pavilions Mall, Denver, CO
- CVS Stores, nationwide
- Weir's furniture Village, nationwide

### HOTELS:

- Gran Hyatt Hotel Chicago, Chicago, IL
- Gran Hyatt Hotel San Francisco, CA
- The Standard Hotel, New York, NY
- Mayfair Hotel, Miami, FL
- Loews Philadelphia Hotel, Philadelphia, PA

### LEISURE AREAS & YMCA:

- Indianapolis Zoo, Indianapolis, IN
- Lion County Safari, Loxahatchee, FL
- Arbolarium of Dallas, TX
- Watermania Aqua Park, Richmond, BC, Canada
- Bowl O Drome Bowling Center, Ithaca, NY
- YMCA of New York City, NY
- YMCA of Greater Miami, FL
- YMCA of Austin, MN
- Arbolarium of Dallas, Dallas, TX
- Bayside YMCA of Barrington, RI

### RECREATIONAL PARKS & VISITOR CENTERS:

- White House Visitors Center, Washington D.C.
- Rocky Mountain National Park, Estes Park, CO
- South Florida parks & recreation Department, FL
- St. Laundry visitor center, Opelousas, LA
- Lake Norman State Park Visitor Center, NC

### RESTAURANTS:

- IHOP restaurants in Broward & Miami-Dade county, FL
- Dunking Donuts, Chicago, IL
- Arby's restaurant, New Albany, IN
- Subways franchise restaurants, FL
- P.F. Chang's Restaurants, Quebec, Canada
- Dominos Pizza, New York, NY
- Havana Spice, Miami, FL
- Kokoriko restaurants, FL
- Pollo Tropical restaurants, San Juan, PR
- Havana Spice, Miami, FL
- IVAR'S restaurant, Seattle, WA
- Novechento Downtown restaurant, Miami, FL
- Vittoria Coffe, Boston, MA

### CHURCHES:

- Philadelphia Baptist church, FL
- Union Gospel Mission, Seattle, WA
- Catholic Charities, Chicago, IL
- Church of the Holy Spirit, Lake Forest, IL
- First United Methodist Church, Miami, FL

### OTHERS:

- Ohio State Penitentiary, Youngstown, OH
- Texas Department of Transportation, TX
- New York Stock Exchange Building, New York, NY
- Brazos Town Hall, Rosenberg, TX
- Nassau Tennis Club, Skillman, NY
- Glendale Heights Police Station, Glendale Heights, IL



**LOW TRAFFIC**

This model is suitable for installation in areas with low traffic.

**MEDIUM TRAFFIC**

This model is suitable for installation in areas with medium traffic.

**HIGH TRAFFIC**

This model is suitable for installation in areas with high traffic.

**ELECTRICAL PROTECTION**

This model incorporates elements that ensure electrical insulation.

**LOW ELECTRICITY CONSUMPTION**

Eco-efficient hand dryer with low electricity consumption/high energy savings.

**VALUE FOR MONEY**

This model offers excellent value for money.

**VANDAL-PROOF**

This model incorporates elements of features that make it difficult or impossible to damage or remove.

**NUTS AND BOLTS INCLUDED**

This model includes the nuts and bolts necessary for it to be installed on masonry walls.

**LOCKED WITH KEY****BIOCOTE**

Anti-microbe treatment for DUALFLOW PLUS hand dryers.

**ADA STANDARDS**

Model which, when installed correctly, complies with the Accessibility Guidelines for Buildings and Facilities ADAAG.

**5 YEARS LIMITED WARRANTY****10 YEARS LIMITED WARRANTY****UNITS PER PALLET**

Unit quantities per pallet. The type of pallet is in between brackets, and dimensions of the pallets are as follows:

- (A) 120 x 80 x 110 cm
- (B) 120 x 80 x 120 cm
- (C) 120 x 80 x 130 cm



General Catalog 2013-2014 - MK272

Distributed by



3325 NW 70th Avenue,  
Miami, FL 33122  
USA  
Toll-free: +1 (877) 222 91 25  
Tel: (305) 424 2433  
Fax: (305) 424 2435  
sales@saniflowcorp.com  
www.saniflowcorp.com