



## Event Log Display

**Code 1120:** Event Log Display Frame, stainless steel finish.  
Overall dimensions in inches (centimeters in brackets)



Door catch top and bottom

Door in open position  
(Door must be lifted to swing open)

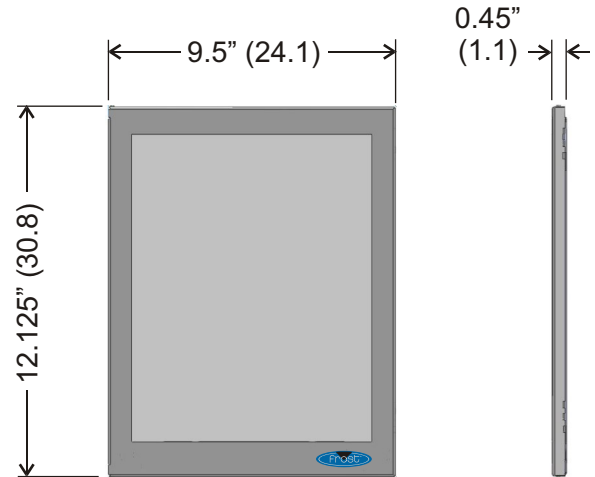

## Specifications

**Site Location:** • Ideal for any areas that are accessed by the general public.

**Features:**

- Tamper resistant opening without the use of a key.
- Ability to update form without removing paper.
- Complete enclosure of paper (8-1/2" x 11").
- Durable acrylic glazing.
- All stainless steel frame.
- Easy opening and closing.
- Mounting screws provided.





## Event Log Operating Instructions

1

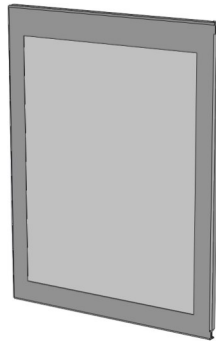

Unit with door closed and locked

2

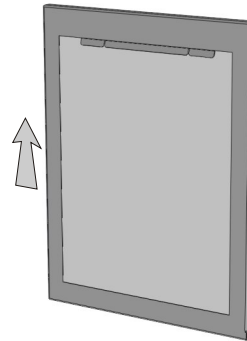

Lift frame to unlock

3

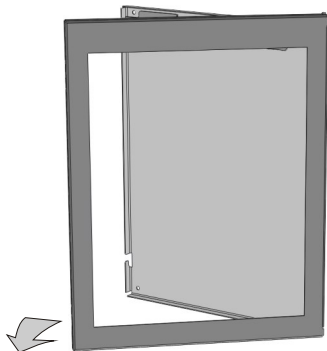

Swing out door

4

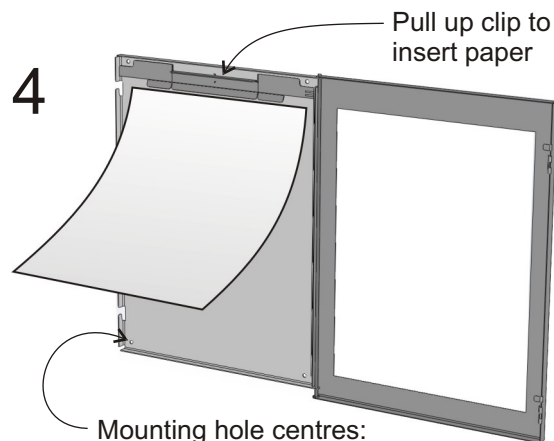

Pull up clip to insert paper

Mounting hole centres:  
9" x 12-3/16"  
203mm x 309mm

5

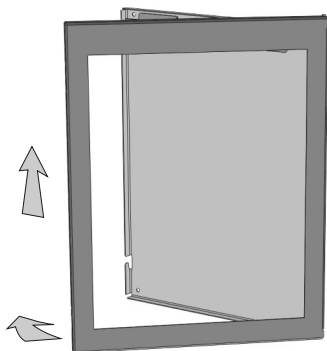

Lift frame and swing closed

6

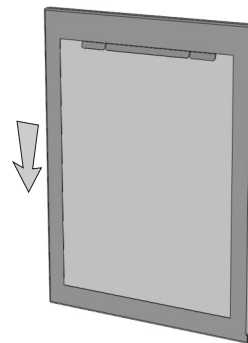

Allow frame to lower into locked position