

Premier



DYNASTY
HARDWARE

Steel Access Panel Doors

1

About Access Panels:

Steel Access Panels provide a convenient way to access important systems within the interior of a building, while keeping the utilities concealed for safety and appearance.

Access panels fit into a rough opening either in a wall or ceiling and mounted securely.

Installs easy to most flat surfaces including drywall, plaster, tile and masonry.

The panels can conceal Plumbing, Electrical, HVAC, or anything requiring servicing or access to.

Premier offers 4 different Galvanized Steel Series with Screwdriver or Keyed options.



Steel Access Panel Doors FL-1000 Series



Screwdriver Latch



- Specifications:** For Walls and Ceilings
- Material:** Galvanized Steel: 15ga (0.071in) door and frame
- Door:** Flush to edge of frame
- Frame:** 5/8" wide flange with 1-1/4" deep mounting frame
- Hinge:** Continuous Hinge
- Door Opening Angle:** Set to open to 110 degrees
- Insulation:** No
- Gasketing:** No
- Latch Options:** Screwdriver operated cam latch
- Finish:** Powder Coated White
- Fire Rated:** No

Steel Access Panel Doors FL-1000 Series

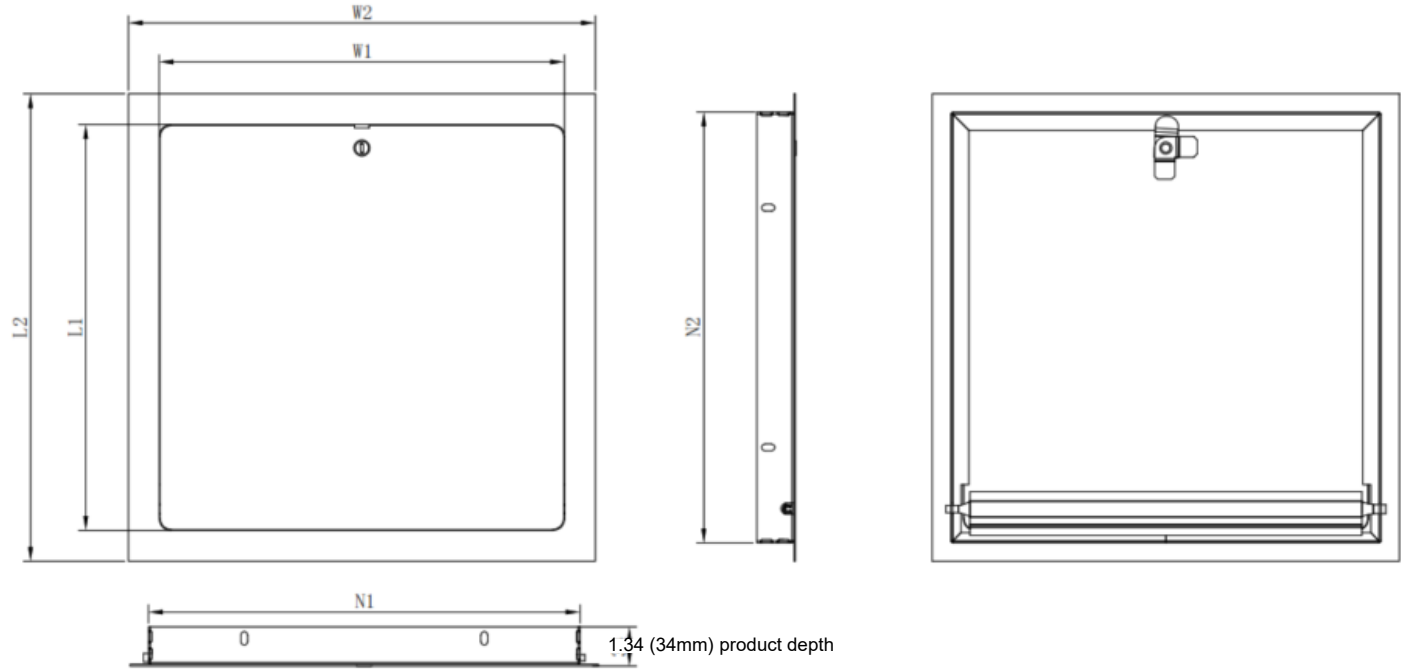

FL-1000 Series Screw Driver Latch		Neck Size N1		Neck Size N2		Opening Size W1		Opening Size L1		Overall Size W2		Overall Size L2	
Dynasty Item #	Nominal Size (in)	mm	in	mm	in	mm	in	mm	in	mm	in	mm	in
FL-1000-6x6	6x6	174	6.85	174	6.85	152	5.98	152	5.98	206	8.11	206	8.11
FL-1000-8x8	8x8	225	8.86	225	8.86	203	7.99	203	7.99	257	10.12	257	10.12
FL-1000-10x10	10x10	276	10.87	276	10.87	254	10.00	254	10.00	308	12.13	308	12.13
FL-1000-12x12	12x12	327	12.87	327	12.87	305	12.01	305	12.01	359	14.13	359	14.13
FL-1000-14x14	14x14	378	14.88	378	14.88	356	14.02	356	14.02	410	16.14	410	16.14
FL-1000-16x16	16x16	428	16.85	428	16.85	406	15.98	406	15.98	460	18.11	460	18.11
FL-1000-18x18	18x18	479	18.86	479	18.86	457	17.99	457	17.99	511	20.12	511	20.12
FL-1000-24x24	24x24	631	24.84	631	24.84	609	23.98	609	23.98	663	26.10	663	26.10

Steel Access Panel Doors FL-2002 Series

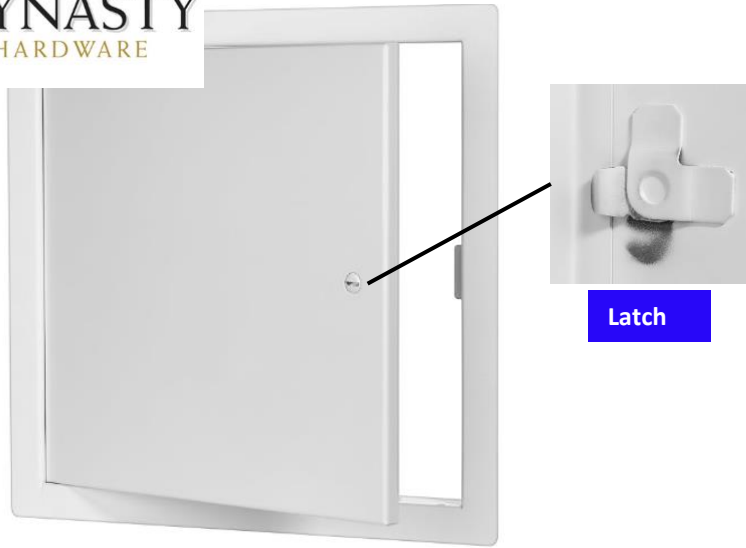

Screwdriver Latch



Cam Latch On Interior
 The Cam Latch Holds The Door Shut

Key Latch
 Comes with minimum 2 keys

- Specifications:** For Walls and Ceilings
- Material:** Galvanized Steel: 16ga (0.063in) door and frame
- Door:** Flush to edge of frame
- Frame:** 7/8" wide flange with 1-3/8" deep mounting frame
- Hinge:** Hidden Pin Hinge
- Door Opening Angle:** Set to open to 135 degrees
- Insulation:** No
- Gasketing:** No
- Latch Options:** Screwdriver or key operated options
- Finish:** Powder Coated White
- Fire Rated:** No

Both Screwdriver and Key Types

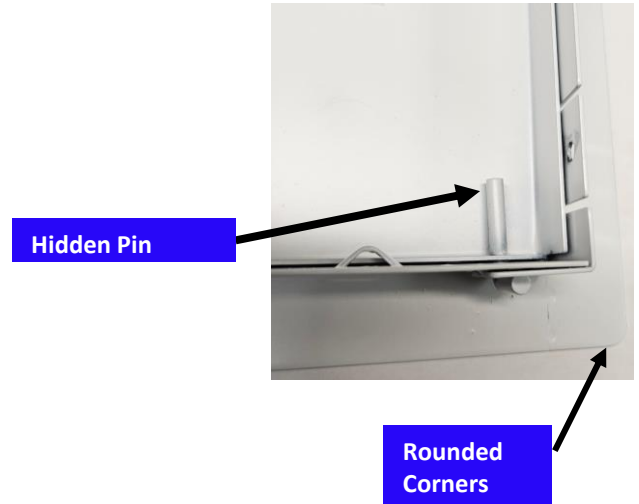

Steel Access Panel Doors FL-2002 Series

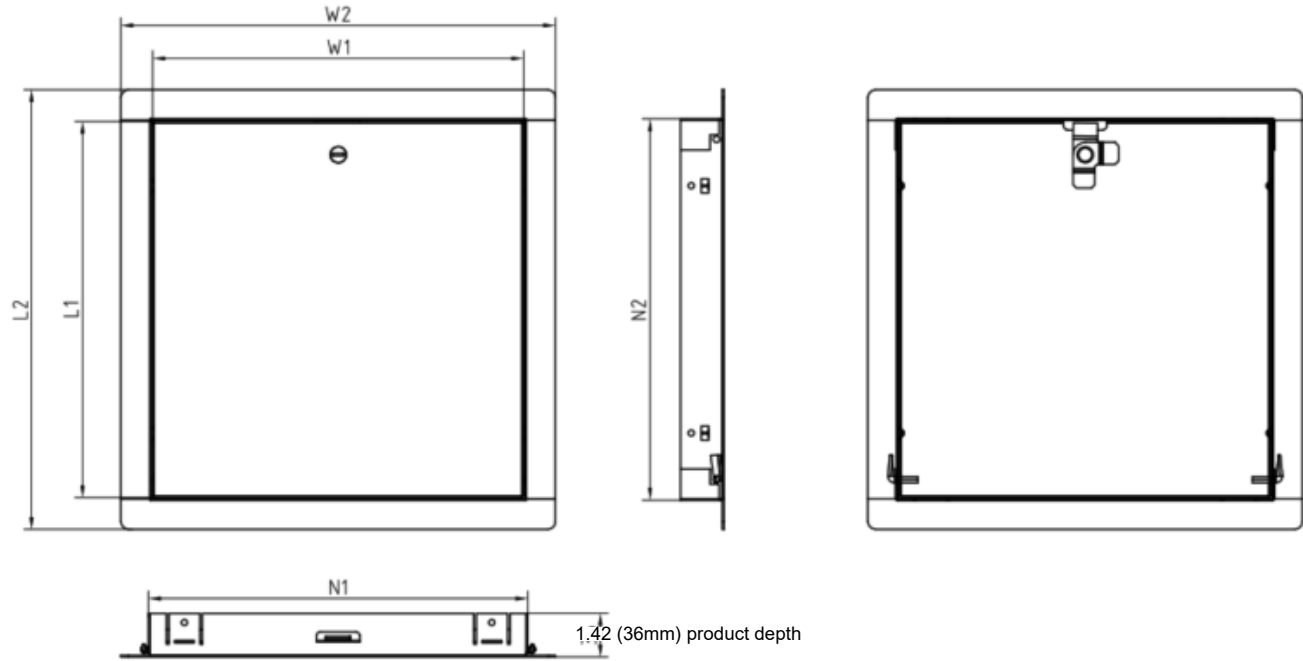

FL-2002 Series Screw Driver Latch		Neck Size N1		Neck Size N2		Opening Size W1		Opening Size L1		Overall Size W2		Overall Size L2	
Dynasty Item #	Nominal Size (in)	mm	in	mm	in	mm	in	mm	in	mm	in	mm	in
FL-2002-8x8	8x8	209	8.23	213	8.39	202	7.95	206	8.11	254	10.00	258	10.16
FL-2002-10x10	10x10	259	10.20	263	10.35	252	9.92	256	10.08	304	11.97	308	12.13
FL-2002-12x12	12x12	310	12.20	311	12.24	303	11.93	307	12.09	355	13.98	359	14.13
FL-2002-14x14	14x14	361	14.21	365	14.37	354	13.94	358	14.09	406	15.98	410	16.14
FL-2002-16x16	16x16	412	16.22	416	16.38	405	15.94	409	16.10	457	17.99	461	18.15
FL-2002-18x18	18x18	463	18.23	467	18.39	456	17.95	460	18.11	508	20.00	512	20.16
FL-2002-22x22	22x22	563	22.17	565	22.24	559	22.01	562	22.13	610	24.02	613	24.13
FL-2002-24x24	24x24	615	24.21	619	24.37	608	23.94	612	24.09	660	25.98	664	26.14
FL-2002-12x24	12x24	310	12.20	616	24.25	308	12.13	612	24.09	360	14.17	660	25.98

Steel Access Panel Doors

FL-2002 Series

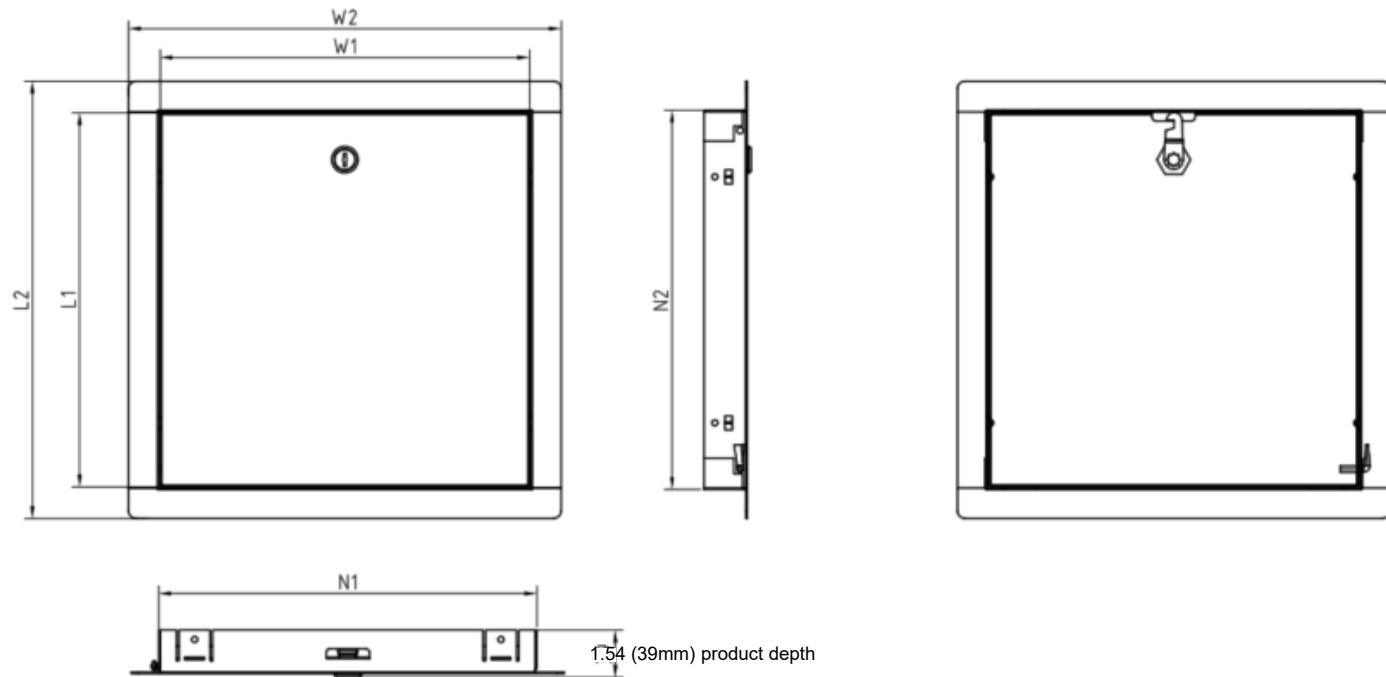

FL-2002 Series Cylinder Key Lock		Neck Size N1		Neck Size N2		Opening Size W1		Opening Size L1		Overall Size W2		Overall Size L2	
Dynasty Item #	Nominal Size (in)	mm	in	mm	in	mm	in	mm	in	mm	in	mm	in
FL-2002-8x8-K	8x8	209	8.23	213	8.39	202	7.95	206	8.11	254	10.00	258	10.16
FL-2002-10x10-K	10x10	259	10.20	263	10.35	252	9.92	256	10.08	304	11.97	308	12.13
FL-2002-12x12-K	12x12	310	12.20	311	12.24	303	11.93	307	12.09	355	13.98	359	14.13
FL-2002-14x14-K	14x14	361	14.21	365	14.37	354	13.94	358	14.09	406	15.98	410	16.14
FL-2002-16x16-K	16x16	412	16.22	416	16.38	405	15.94	409	16.10	457	17.99	461	18.15
FL-2002-18x18-K	18x18	463	18.23	467	18.39	456	17.95	460	18.11	508	20.00	512	20.16
FL-2002-22x22-K	22x22	563	22.17	565	22.24	559	22.01	562	22.13	610	24.02	613	24.13
FL-2002-24x24-K	24x24	615	24.21	619	24.37	608	23.94	612	24.09	660	25.98	664	26.14
FL-2002-12x24-K	12x24	310	12.20	616	24.25	308	12.13	612	24.09	360	14.17	660	25.98



Steel Access Panel Doors FL-3000 Series



Screwdriver Latch



Key Latch
 Comes with minimum 2 keys

- Specifications:** For Walls and Ceilings
- Material:** UOS Galvanized Steel: 20ga (0.04in) door and frame.
- **Door:** Flush to edge of frame, Removable
- Frame:** 3/4" wide flange with 1" deep mounting frame
- Hinges:** Steel rod hinge with spring on one side
- Door Opening Angle:** Set to open to 120 degrees
- Insulation:** No
- Gasketing:** No
- Latch Options:** Screwdriver or key operated options
- Finish:** Powder Coated White
- Fire Rated:** No



Swing Mounting Tabs

Can be adjusted to any direction to anchor to different depths

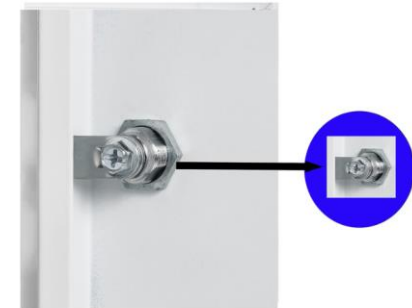

Cam Latch On Interior

The Cam Latch Holds The Door Shut

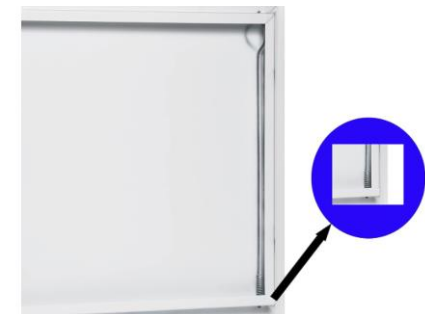

Removable Door

Gain Greater Access To Work Area
 Open Door Then Depress Spring To Remove Door

Steel Access Panel Doors

FL-3000 Series

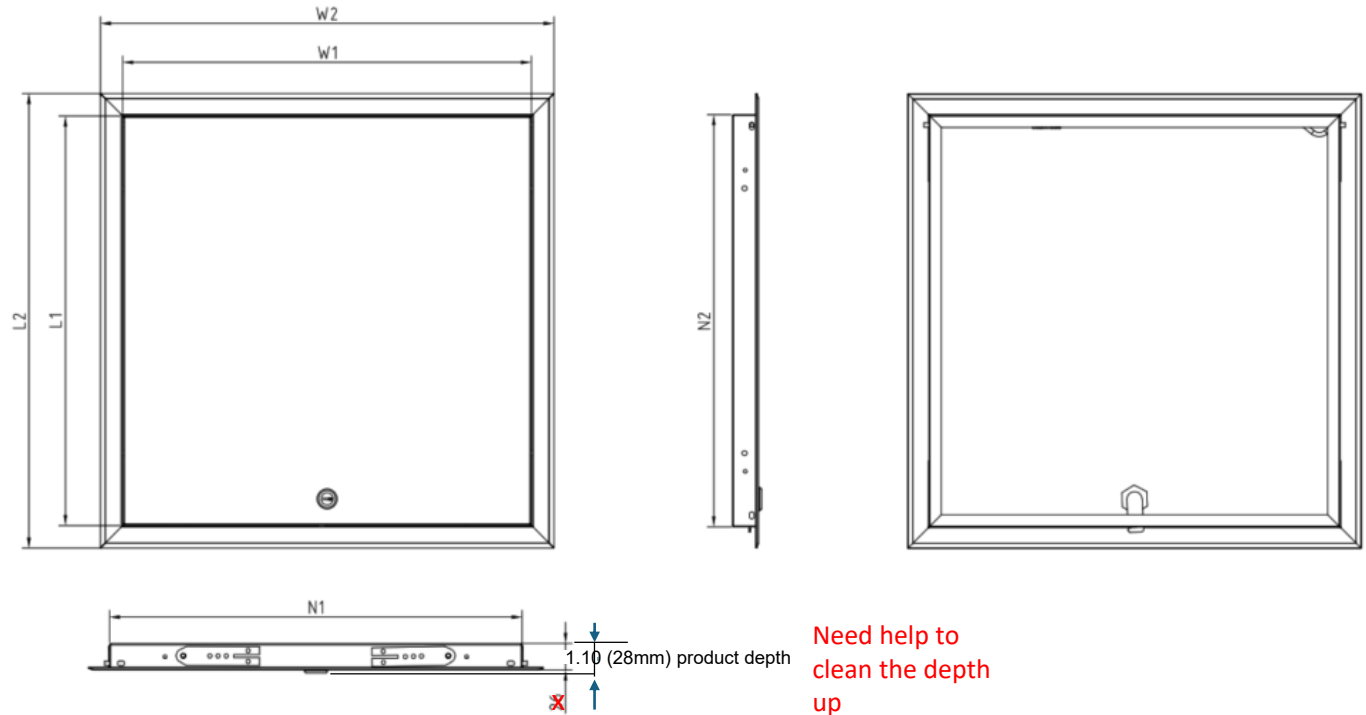

FL-3000 Series Screw Driver Latch		Neck Size N1		Neck Size N2		Opening Size W1		Opening Size L1		Overall Size W2		Overall Size L2	
Dynasty Item #	Nominal Size (in)	mm	in	mm	in	mm	in	mm	in	mm	in	mm	in
FL-3000-6x6	6x6	154	6.06	154	6.06	152	5.98	152	5.98	192	7.56	192	7.56
FL-3000-8x8	8x8	205	8.07	205	8.07	203	7.99	203	7.99	243	9.57	243	9.57
FL-3000-10x10	10x10	256	10.08	256	10.08	254	10.00	254	10.00	294	11.57	294	11.57
FL-3000-12x12	12x12	307	12.09	307	12.09	305	12.01	305	12.01	345	13.58	345	13.58
FL-3000-14x14	14x14	358	14.09	358	14.09	356	14.02	356	14.02	396	15.59	396	15.59
FL-3000-16x16	16x16	408	16.06	408	16.06	406	15.98	406	15.98	446	17.56	446	17.56
FL-3000-18x18	18x18	460	18.11	460	18.11	457	17.99	458	18.03	498	19.61	498	19.61
FL-3000-22x22	22x22	560	22.05	560	22.05	559	22.01	559	22.01	598	23.54	598	23.54
FL-3000-24x24	24x24	611	24.06	611	24.06	609	23.98	609	23.98	649	25.55	649	25.55
FL-3000-12x24	12X24	307	12.09	307	12.09	305	12.01	609	23.98	345	13.58	649	25.55

Notes: 24x24 Size is 19ga

Steel Access Panel Doors FL-3000 Series

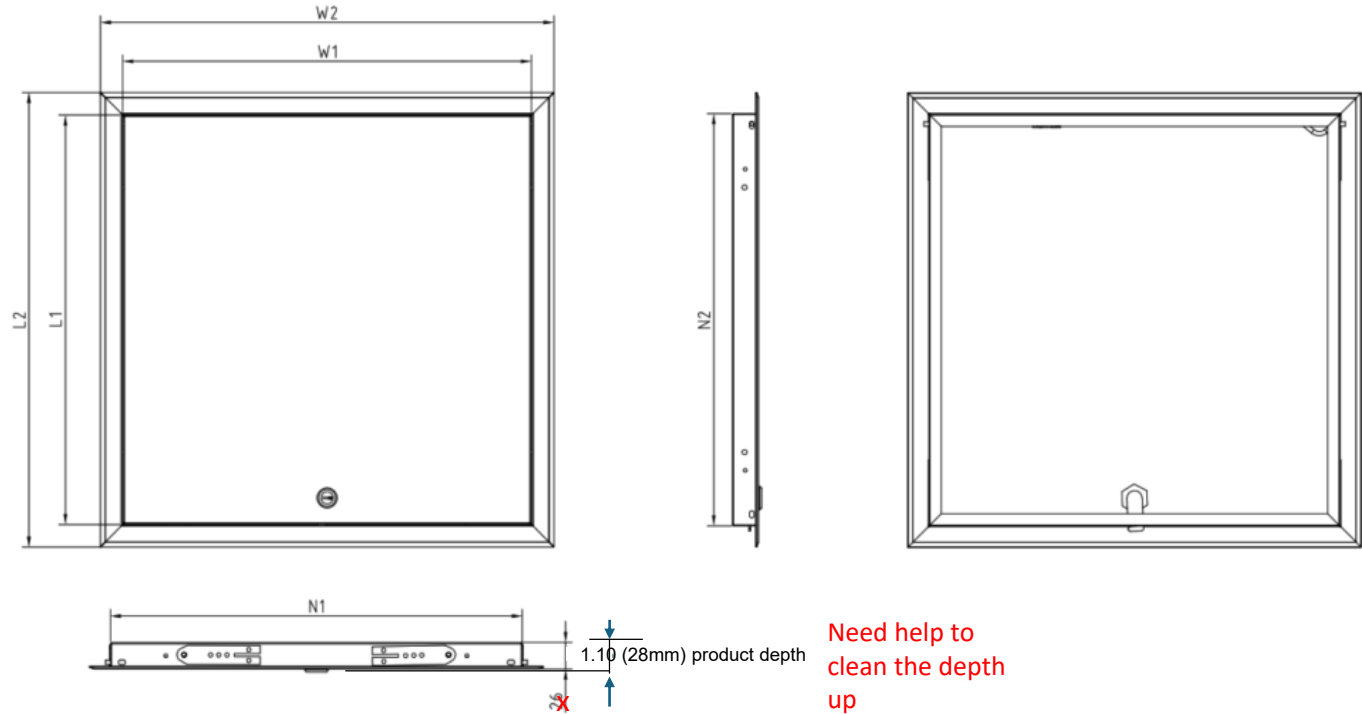

FL-3000 Series Cylinder Key Lock		Neck Size N1		Neck Size N2		Opening Size W1		Opening Size L1		Overall Size W2		Overall Size L2	
Dynasty Item #	Nominal Size (in)	mm	in	mm	in	mm	in	mm	in	mm	in	mm	in
FL-3000-6x6-K	6x6	154	6.06	154	6.06	152	5.98	152	5.98	192	7.56	192	7.56
FL-3000-8x8-K	8x8	205	8.07	205	8.07	203	7.99	203	7.99	243	9.57	243	9.57
FL-3000-10x10-K	10x10	256	10.08	256	10.08	254	10.00	254	10.00	294	11.57	294	11.57
FL-3000-12x12-K	12x12	307	12.09	307	12.09	305	12.01	305	12.01	345	13.58	345	13.58
FL-3000-14x14-K	14x14	358	14.09	358	14.09	356	14.02	356	14.02	396	15.59	396	15.59
FL-3000-16x16-K	16x16	408	16.06	408	16.06	406	15.98	406	15.98	446	17.56	446	17.56
FL-3000-18x18-K	18x18	460	18.11	460	18.11	457	17.99	458	18.03	498	19.61	498	19.61
FL-3000-22x22-K	22x22	560	22.05	560	22.05	559	22.01	559	22.01	598	23.54	598	23.54
FL-3000-24x24-K	24x24	611	24.06	611	24.06	609	23.98	609	23.98	649	25.55	649	25.55
FL-3000-12x24-K	12X24	307	12.09	307	12.09	305	12.01	609	23.98	345	13.58	649	25.55

Notes: 24x24 Size is 19ga

Steel Access Panel Doors FL-5000 Series



Latch

Screwdriver Latch



Cam Latch On Interior
 The Cam Latch Holds The Door Shut

Key Latch
 Comes with minimum 2 keys

- Specifications:** For Walls and Ceilings
- Material:** Galvanized Steel: 16ga (0.063in). door and frame
- Door:** Flush to edge of frame
- Frame:** 7/8" wide flange with 1-3/8" deep mounting frame
- Hinge:** Hidden Pin Hinge
- Door Opening Angle:** Set to open to 110 degrees
- Insulation:** No
- Gasketing:** No
- Latch Options:** Screwdriver or key operated options
- Finish:** Powder Coated White
- Fire Rated:** No



Square Corners

Continuous Hinge

Steel Access Panel Doors FL-5000 Series

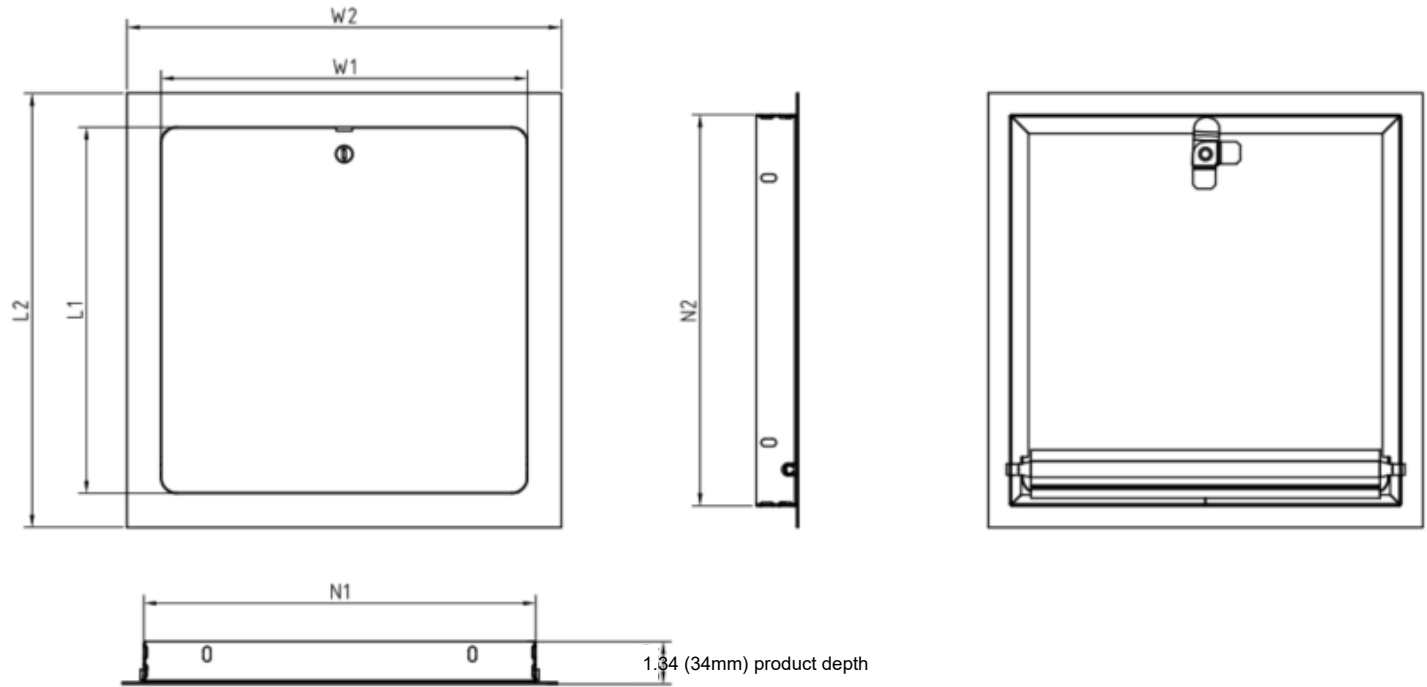

FL-5000 Series Screw Driver Latch		Neck Size N1		Neck Size N2		Opening Size W1		Opening Size L1		Overall Size W2		Overall Size L2	
Dynasty Item #	Nominal Size (in)	mm	in	mm	in	mm	in	mm	in	mm	in	mm	in
FL-5000-6x6	6x6	160	6.30	160	6.30	140	5.51	140	5.51	194	7.64	194	7.64
FL-5000-8x8	8x8	210	8.27	210	8.27	190	7.48	190	7.48	244	9.61	244	9.61
FL-5000-10x10	10x10	262	10.31	262	10.31	241	9.49	241	9.49	295	11.61	295	11.61
FL-5000-12x12	12x12	312	12.28	312	12.28	292	11.50	292	11.50	346	13.62	346	13.62
FL-5000-14x14	14x14	363	14.29	363	14.29	343	13.50	343	13.50	397	15.63	397	15.63
*FL-5000-16x16	16x16	414	16.30	414	16.30	394	15.51	394	15.51	448	17.64	448	17.64
*FL-5000-18x18	18x18	464	18.27	464	18.27	444	17.48	444	17.48	498	19.61	498	19.61
**FL-5000-22x22	22x22	566	22.28	566	22.28	546	21.50	546	21.50	600	23.62	600	23.62
**FL-5000-24x24	24x24	617	24.29	617	24.29	597	23.50	597	23.50	651	25.63	651	25.63
*FL-5000-12x24	12x24	312	12.28	617	24.29	292	11.50	597	23.50	346	26.75	651	25.63

Note: *Has 2 latches, **Has 4 Latches

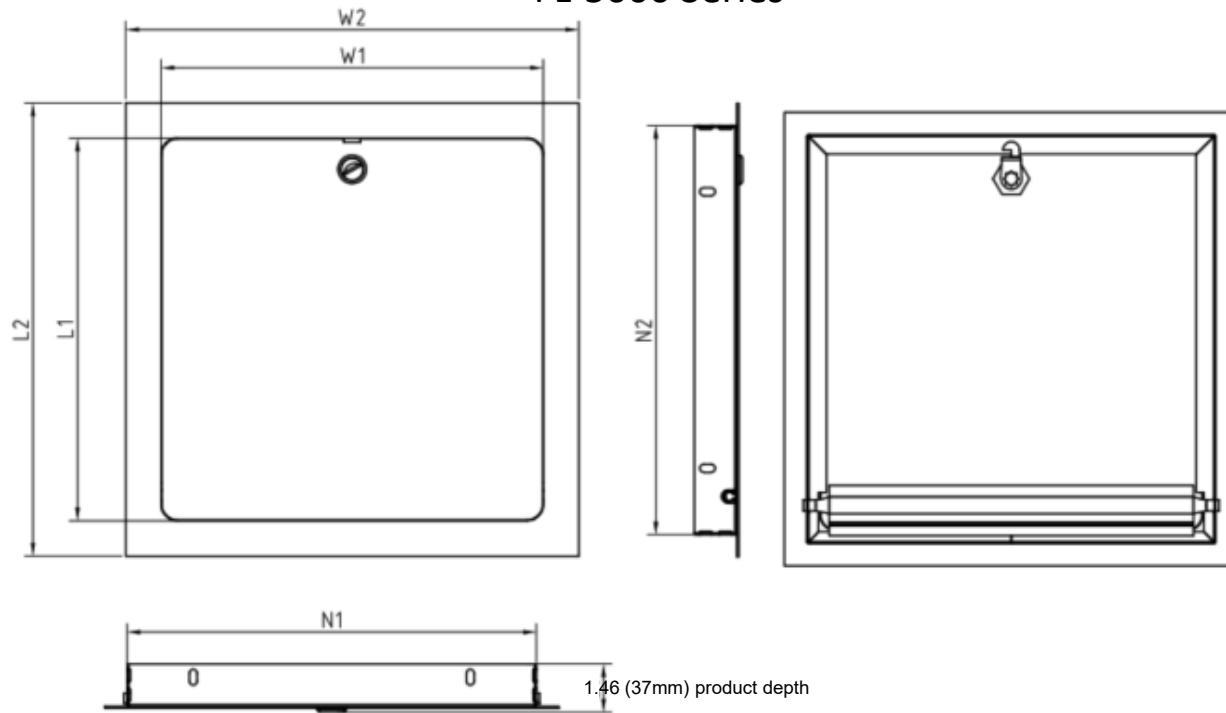
Steel Access Panel Doors
FL-5000 Series

FL-5000 Series Cylinder Key Lock		Neck Size N1		Neck Size N2		Opening Size W1		Opening Size L1		Overall Size W2		Overall Size L2	
Dynasty Item #	Nominal Size (in)	mm	in	mm	in	mm	in	mm	in	mm	in	mm	in
FL-5000-6x6-K	6x6	160	6.30	160	6.30	140	5.51	140	5.51	194	7.64	194	7.64
FL-5000-8x8-K	8x8	210	8.27	210	8.27	190	7.48	190	7.48	244	9.61	244	9.61
FL-5000-10x10-K	10x10	262	10.31	262	10.31	241	9.49	241	9.49	295	11.61	295	11.61
FL-5000-12x12-K	12x12	312	12.28	312	12.28	292	11.50	292	11.50	346	13.62	346	13.62
FL-5000-14x14-K	14x14	363	14.29	363	14.29	343	13.50	343	13.50	397	15.63	397	15.63
*FL-5000-16x16-K	16x16	414	16.30	414	16.30	394	15.51	394	15.51	448	17.64	448	17.64
*FL-5000-18x18-K	18x18	464	18.27	464	18.27	444	17.48	444	17.48	498	19.61	498	19.61
**FL-5000-22x22-K	22x22	566	22.28	566	22.28	546	21.50	546	21.50	600	23.62	600	23.62
**FL-5000-24x24-K	24x24	617	24.29	617	24.29	597	23.50	597	23.50	651	25.63	651	25.63
*FL-5000-12x24-K	12x24	312	24.31	617	36.38	292	24	597	36	346	26.75	651	38.75

Note: *Has 2 latches, **Has 4 Latches

