

MAC 5



OPERATION & SAFETY MANUAL

IMPORTANT SAFETY INFORMATION INSIDE

Read this manual before handling this firearm. Keep this manual with your firearm and review it before each use.
Do not allow others to handle or fire your firearm until they have read this manual.
Transfer this manual with the firearm upon ownership change.

THIS MANUAL IS FOR MAC 5 FIREARMS ONLY.

Be a responsible firearm owner. Use it safely, store it securely, and always transfer a firearm responsibly and legally.

DOWNLOAD THIS MANUEL ON OUR WEBSITE : WWW.SDSIMPORTS.COM

Always check website for updated versions of operation & safety manuals

Contents

Read and Understand this Manual.....	3	Field Strip.....	22
Know Your Firearm.....	4	Reassembly.....	26
Safety Rules.....	6	Parts Diagram.....	28
Safety Device.....	11	Sight Adjustment - Windage.....	32
Determining Firearm is Unloaded/Safe.....	12	Sight Adjustment - Elevation.....	33
Ammunition.....	14	Limited Lifetime Warranty.....	34
Loading/Preparing To Fire.....	16		
Firing.....	17		
Unloading.....	19		
Malfunction Warning!.....	20		

BEFORE LOADING AND FIRING THIS FIREARM, READ AND UNDERSTAND THE INFORMATION IN THIS MANUAL.

This is an auto loading firearm. It is immediately loaded and ready to fire again after each shot until all cartridges loaded in magazine have been fired. The firearm is able to fire both with and without the magazine in place.

REMOVING THE MAGAZINE DOES NOT UNLOAD THE FIREARM NOR DOES IT ENGAGE A SAFETY. THE FIREARM IS NOT UNLOADED UNTIL THE MAGAZINE IS REMOVED AND THE CHAMBER IS EMPTY.

ABOUT YOUR OWNER'S MANUAL

This is an instruction booklet on how to operate this firearm with some basic safe handling rules. It does not attempt to provide information about using a firearm to defend yourself, how to hunt, or for competitive or competent firearms instruction prior to engaging in any of these activities. The National Rifle Association, your local state authorities, or your firearm dealer may provide information regarding available instructors or training courses. If you have a license to carry concealed, never do so without instruction from a certified instructor. Using a firearm for self defense is a complex subject with dangers and risk for which you must be properly trained. Every safety rule has a reason behind it - read the rules carefully and understand why each is important for safety.

It is recommended that every person receive instructions from a competent firearms instructor before handling this or any other firearm.

Know and obey all firearms laws and regulations, which may vary from city to city and state to state. Do not give a firearm to someone who is not allowed to own a firearm or who may use it for a criminal purpose.



WARNING

Altering your MAC-5 firearm in any way could violate local, state or federal laws/regulations.

Used firearms

If you purchased this firearm as a used firearm, have it inspected and tested by a competent gunsmith before you use it. Guns are sometimes altered and may require repair before they can be used safely.

Store firearms safely in the home

Store firearms unloaded, locked and in a secure place. Obey firearm storage laws. Store firearms and ammunition separately.

OBEY ALL FIREARMS LAWS WHEN BUYING AND SELLING FIREARMS. NEVER BUY A GUN INTENDING TO TRANSFER IT TO SOMEONE WHO IS PROHIBITED FROM OWNING FIREARMS. NEVER, EVER BE A "STRAW PURCHASER"

KNOW YOUR FIREARM



KNOW YOUR FIREARM



SAFETY RULES - READ AND UNDERSTAND THESE SAFETY RULES

Be A Safe Shooter.

ACCIDENT N. 1. An unintentional or unexpected happening that is undesirable or unfortunate, especially one resulting in injury, damage, harm or loss.

Don't be the cause of an accident.

A responsible firearm owner is safety minded and always handles firearms in a safe manner by following the basic rules of safe shooting and by using common sense in the handling of a firearm.

Store firearms unloaded, locked, and in a secure place. Keep keys for locks separate from lock and in a secure place away from children. Keep firearms out of reach of children. You are responsible for children's safety.

Be A Responsible Gun Owner.

- **Treat all firearms as if they are loaded at all times.**
- Never point a firearm at any person or thing you do not intend to shoot.
- Keep your finger off the trigger until you are on target and have made the DECISION to fire.

- Be sure you have positively identified your target.
- **ALWAYS KEEP THE MUZZLE POINTED IN A SAFE DIRECTION.**
- **Do not drop your firearm.** Make sure you maintain control of your firearm at all times. **If it falls, it may fire.** If you do drop it, unload it and examine it to be sure it works correctly. Do not attempt to fire it again until you have completed this safety check.
- Never put your hand over the muzzle of the firearm.
- Keep your finger(s) off the trigger and out of the trigger guard until you are actually aiming at your target, and made the decision to fire.
- Under no circumstances should the owner/purchaser of this firearm allow it to come into possession of or be handled by small children or a mentally handicapped individual.
- **DO NOT COVER THE EJECTION PORT WITH YOUR HANDS WHEN LOADING/UNLOADING YOUR FIREARM.**

TREAT EVERY GUN AS IF IT IS LOADED ... ALL THE TIME.

BE A RESPONSIBLE FIREARM OWNER!

- Never rely on a firearm's "safety features" to protect you from unsafe firearm handling. A safety is only a mechanical device, not a substitute for common sense.
- Keep your finger off the trigger until you are on target and have made the DECISION to fire.
- Be sure of your target and backstop before you shoot. Ask yourself what your bullet will hit if it misses or goes through the target.
- Before shooting, be sure the barrel is clear of obstructions, including excessive oil and grease.
- Do not let water, snow, mud or other materials enter the barrel.
- Do not pull a firearm toward you by the muzzle.
- Always hold your firearm so you control the direction of its muzzle in case you fall or stumble.
- If anything does get into the barrel, remove cartridges, and clean bore immediately before attempting to shoot. Obstructed barrels can burst and injure you and/or bystanders.
- Maintain possession of your firearm at all times when you are on the firing range or during target practice. **DO NOT ALLOW OTHERS TO HANDLE YOUR FIREARM UNLESS THAT PERSON IS BEING INSTRUCTED OR TRAINED.**
- **ALWAYS KEEP THE MUZZLE POINTED IN A SAFE DIRECTION.**
- Firearms and alcohol or drugs do not mix. Do not take them before or during shooting activities. Your vision, coordination and judgment could be impaired, making firearm handling unsafe.
- When taking medication, seek a doctor's advice to be sure you can operate and handle your firearm safely. Receive training from a competent firearms instructor before using any firearm.
- Before attempting to shoot, practice operations by using snap caps (dummy rounds). Become familiar with the safety features, trigger control, and handling of the firearm.
- Make sure you maintain control of your firearm at all times.
- **Always keep and carry your firearm with an empty chamber until you intend to shoot, so your firearm cannot be fired unintentionally.**
- Firearms should be unloaded when not in use. This means both the chamber and magazine are empty.
- When transferring a firearm by hand, always open the action and check to assure that it is unloaded prior to handing it over to someone.
- Never take anyone's word that a firearm is unloaded. When receiving a firearm, always open the action and check that it is unloaded.



WARNING

The MAC-5 firearm, like all firearms, is a dangerous firearm if not handled properly.

BE A SAFE FIREARM OWNER!

- **Do not try to change your firearm's trigger pull, because alterations of trigger pull usually affect the fit of critical parts and might cause accidental firing.**
- Never use a firearm that jams or fails to function properly. Should this occur, return it to SDS Imports for warranty/repair.
- If your shot sounds weak or underpowered, it could mean a bullet is in the chamber/bore. The gun should be immediately unloaded and the chamber/bore checked for obstructions before refiring.
- **DO NOT "HORSEPLAY"** with a firearm. Your firearm cannot think, but you can. Firearm safety depends on you.

WARNING



IMPORTANT WARNING

There is no safe way to discharge a firearm in a home or apartment. Bullets will go through walls, floors, furniture, and appliances and still cause serious injury or death to persons in the house, next-door, or outside. Accidental discharges indoors ALWAYS result in property damage or personal injury.

WARNING



When you squeeze the trigger, you must expect the firearm to fire. You must take full responsibility for firing it. Your care can avoid accidental discharge and thereby avoid accidental injury and death.

READ THESE RULES!

- Load firearm only when on range preparing to fire. Unload it before leaving range.
- **Treat every firearm as if it is loaded... all the time!**
- Load and unload with the firearm muzzle pointed in a safe direction.
- Be certain firearm is unloaded before cleaning.
- Completely unload your firearm before storing, travelling, standing it against an object, laying it down, entering a house, car, truck, boat, RV/camper, building, or handing it to someone.
- **Never leave a loaded firearm unattended.**
- Tragedy may result if a child finds your firearm and plays with it. Keep every firearm secure. Children do not understand firearms can kill.
- Store firearms and ammunition separately. Both should be placed beyond children's reach.
- Obey all laws regarding the storage and security of firearms in the home.
- Know and obey the laws regarding the transportation and carrying of firearms.
- **Old or reloaded ammunition may cause damage to the firearm and/or injure you or others. Use only clean, dry, original, high-quality, commercially manufactured ammunition. Using reloaded ammunition may void the warranty.**
- **ALWAYS REMEMBER, REMOVING THE MAGAZINE DOES NOT UNLOAD THE FIREARM NOR DOES IT ENGAGE A SAFETY.**
- **ALWAYS REMEMBER, THE FIREARM IS NOT UNLOADED UNTIL THE MAGAZINE IS REMOVED AND THE CHAMBER IS EMPTY.**
- **ALWAYS REMEMBER, THIS FIREARM IS ABLE TO FIRE WITH OR WITHOUT THE MAGAZINE IN PLACE.**

TREAT EVERY FIREARM AS IF IT IS LOADED... ALL THE TIME!

- Many ammunition identifications sound similar. Make sure you use the right caliber/size ammunition in your firearm.
- If firearm fails to fire when the trigger is pulled, keep it pointed at the target for at least 30 seconds. Remove the magazine before opening the action. Remove the cartridge from the chamber. Sometimes slow primer ignition will cause a “hang fire” and the cartridge will go off after a short pause.
- When group firing, always appoint someone to maintain safety control. Obey his/her commands immediately and completely.
- While shooter is loading, firing, and unloading, spectators need to remain behind shooter.
- **Always wear protective glasses when shooting.**
- **Always wear hearing protection when shooting.**
- Never shoot at hard flat surfaces or water; bullets will ricochet unpredictably.
- **Do not alter or modify your firearm.**
- Have your firearm serviced regularly by a qualified gunsmith.
- Discharging firearms in poorly ventilated areas, cleaning firearms, or handling ammunition may result in exposure to lead and other substances known to cause birth defects, reproductive harm, cancer and other serious physical injury. Have adequate ventilation at all times. Wash hands thoroughly after firing your firearm, after cleaning your firearm, or whenever you have handled ammunition.
- Always use quality ammunition.
- **ALWAYS KEEP THE MUZZLE POINTED IN A SAFE DIRECTION.**



Safety and instruction manuals are available from SDS Imports



Always wear eye and ear protection when using any firearm.

SAFETY DEVICE

The MAC-5 is equipped with a safety selector located just above and to the rear of the trigger. Any time the firearm is loaded the safety selector should be moved to the “SAFE” position (Figure 11-1). To fire simply rotate the safety selector to the “FIRE” position (Figure 11-2). Return to the “SAFE” position after firing.



DETERMINE FIREARM IS UNLOADED/SAFE

Always make sure firearm is unloaded before handling.

1. POINT FIREARM IN SAFE DIRECTION WHILE KEEPING YOUR FINGER OFF OF THE TRIGGER.
2. Press magazine release to remove magazine (Figure 12-1 or 12-2).
3. With finger off the trigger, fully retract the charging handle and lift upwards into retention notch to lock it to the rear (Figure 12-3).
4. Carefully inspect chamber to make sure it is empty.

When chamber is empty, rotate the safety selector to “SAFE” (see page 11).



Caution: Do not cover the ejection port with your hand when firing your rifle.



Figure 12-1



Figure 12-2



Figure 12-3



WARNING

Firearm is not empty or unloaded until the magazine is removed and the chamber is empty. To properly clear a firearm, remove the magazine, then pull charging handle back and check the chamber.

NOTES

A series of 18 horizontal dotted lines for writing notes.

AMMUNITION

Locate the cartridge designation, for caliber, marked on the left side of receiver. This information indicates the correct ammunition that must be used in your firearm (Figure 14-1).

You are responsible for selecting ammunition that meets industry standards and is appropriate in type and caliber for this firearm.

Never mix ammunition.

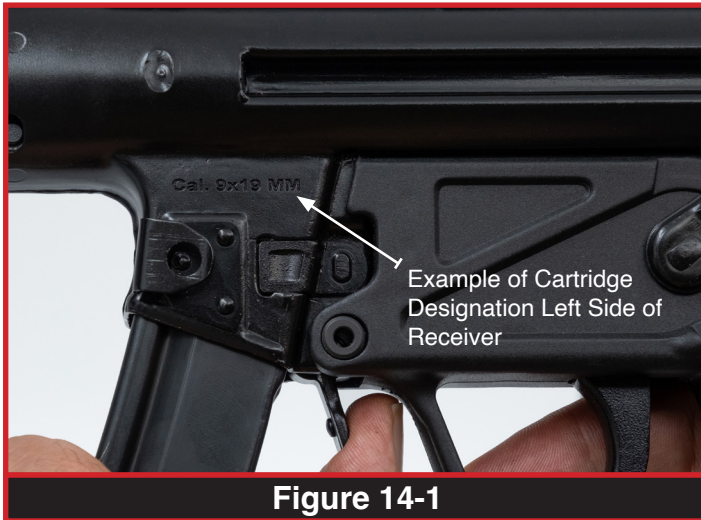

WARNING



Never use ammunition not specifically designated for use in your firearm. Failure to use the correct type or caliber of ammunition may cause the firearm to jam, or fail to fire, or may generate excessive pressure which can damage or even rupture your firearm, causing personal injury or death to the shooter or bystanders.

WARNING



Always inspect your ammunition before using it. Never use dirty, corroded or damaged ammunition. A burst cartridge may result, causing damage to the firearm and personal injury or death to the shooter or bystanders.

WARNING



In some cases, a round of ammunition not specified on your firearm and not listed as alternate ammunition in this manual, may fit into the chamber. Firing this ammunition may cause a rupture resulting in damage to the firearm and personal injury or death to the shooter or bystanders. For more information regarding usage of caliber combination, refer to: www.SAAMI.org

AMMUNITION

A firearm and ammunition are a system and must work together. There are different types of ammunition for different types of firearms. Your firearm has been designed for ammunition of a specific type and a specific gauge or caliber. It is important to select the proper ammunition for your firearm.

Different combinations of bullet velocity, bullet weight and firearm weight can have major impact on felt recoil; high felt recoil can be uncomfortable to some shooters.

CAUTION: Use of ammunition manufactured with corrosive primers in this firearm is not recommended and will cause oxidation to develop on any metal parts of the firearm. To prevent such oxidation, the residue from corrosive primers must be completely removed from all metal parts after each time ammunition with corrosive primers is used in this firearm. Conventional oil or solvent-based firearm cleaners **WILL NOT** dissolve the residue from corrosive primers. Residue from corrosive primers **MUST** be completely dissolved with a water-based cleaner. After the corrosive residue has been completely dissolved from all metal parts, remove any excess water-based cleaner from the firearm.

Finally, lubricate the firearm as instructed in the Safety and Instruction Manual. Failure to follow these instructions will cause damage to the firearm and may affect the ability of the firearm to function properly.

Check with the ammunition manufacturer or a qualified gunsmith if you are unsure whether the particular ammunition you plan to use in this firearm has been manufactured with corrosive primers. If in doubt, follow all the instructions above to prevent oxidation caused by ammunition manufactured with corrosive primers.

Ammunition manufactured by SAAMI member companies does not have corrosive primers.

LOADING / PREPARING TO FIRE

1. Lock the charging handle to the rear by retracting the charging handle completely, then lifting the handle upwards into the locking notch (Figure 16-1). The bolt should be locked rearward. Rotate safety lever to the safe position (See Page 11).
2. Ensure that you are using the proper caliber ammunition for your firearm. Place rim of first cartridge on top of follower (Figure 16-2) then push the cartridge down on the follower until the lips capture the round. Load successive rounds by pushing cartridge down on previously loaded cartridge. Use only clean, dry, original, high quality, commercially, manufactured ammunition. Using reloaded ammunition may void warranty.
3. **POINT FIREARM IN A SAFE DIRECTION AND KEEP FINGER OFF TRIGGER.** Insert **LOADED** magazine into magazine well, located in bottom of firearm. Push firmly enough on bottom of magazine to make sure it is properly seated.



Caution: Do not slam or forcefully jam magazine into magazine well.

4. Charge the firearm by driving the charging handle downward with authority using your support hand (Figure 16-3). The bolt will ram forward loading a cartridge. If the bolt is forward, charge the pistol by fully retracting the charging handle and releasing it, allowing it to drive forward loading the chamber.
5. Rotate the safety selector to “SAFE” (see page 11) if not there already.
6. **The firearm is now loaded and ready to fire.**



Always wear eye and ear protection when using any firearm.



Caution: Never load cartridge by hand directly into the chamber.



WARNING

Never touch the trigger when loading or unloading the firearm.

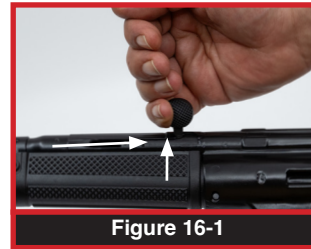

Figure 16-1

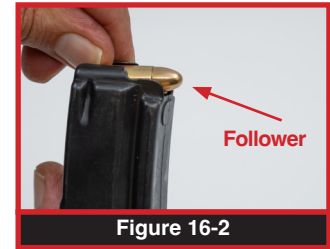

Figure 16-2

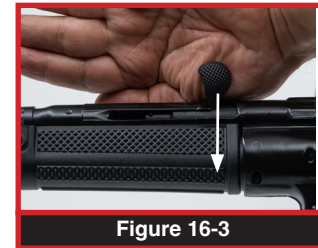

Figure 16-3

FIRING

If you have never fired a firearm before, follow the sequence of operations shown here without ammunition or with snap caps. Then load only **one** cartridge into the magazine for your first live ammunition firing.

1. POINT FIREARM IN A SAFE DIRECTION WHILE KEEPING YOUR FINGER OFF OF THE TRIGGER.
2. Load cartridge into chamber from magazine following the procedure described on page 16. Rotate safety selector to “SAFE” (see page 11) if not there already.
3. Grasp grip of firearm firmly.



Caution: Do not slam or forcefully jam magazine into magazine well.

4. Aim firearm at target by aligning sights. Rotate safety selector to “Fire” (see page 11).



Safety and instruction manuals are available from Sds Imports



Always wear eye and ear protection when using any firearm.



Point firearm in a safe direction at all times.

5. Now lightly place finger on trigger, and slowly squeeze trigger to fire the firearm. Spent cartridge is expelled up and to the right.

NOTE: This is an auto loading firearm. It is immediately loaded and ready to fire again after each shot until all cartridges loaded in magazine have been fired. The firearm is able to fire both with and without the magazine in place.

6. The pistol will automatically be ready to fire again after each shot until all cartridges loaded in magazine have been fired.

REMOVING THE MAGAZINE DOES NOT UNLOAD THIS FIREARM NOR DOES IT ENGAGE A SAFETY. THIS FIREARM IS NOT UNLOADED UNTIL THE MAGAZINE IS REMOVED AND THE CHAMBER IS EMPTY.



WARNING

Loading the MAC-5 by manually inserting a round in the chamber is improper and could cause accidental discharge, possible damage to the firearm or personal injury. Always load the firearm using the magazine. When loading the firearm, always point the muzzle in a safe direction.

FIRING

POINT FIREARM IN SAFE DIRECTION WHILE KEEPING YOUR FINGER OFF OF THE TRIGGER.

7. Put safety selector on “SAFE” (see page 11).
8. Press magazine release to remove magazine.
9. Carefully inspect chamber to make sure it is empty (Figure 18-1)



CAUTION: Do not cover the ejection port with your hand when firing your rifle/pistol.

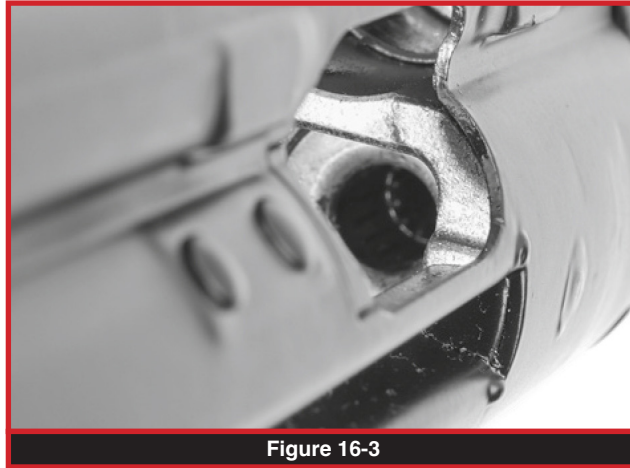

Figure 16-3



WARNING

Firearm is not empty or unloaded until the magazine is removed and the chamber is empty. To properly clear a firearm, remove the magazine, then pull charging handle back and check the chamber.

UNLOADING

1. Rotate safety selector to “SAFE” position (see page 11).
2. While pointing the muzzle in a safe direction, remove the magazine by depressing the magazine release and pulling the magazine out (Figure 19-1 or 19-2).
3. With your finger off trigger fully retract charging handle, ejecting cartridge.
4. Release/lower charging handle.
5. Re-inspect chamber to insure firearm is unloaded. Retract charging handle and insert chamber flag and slowly lower charging handle. Push charging handle to the closed position.



CAUTION: Step 5 is a crucial part of the unloading process. Do not depend on the fact that no casing was ejected on clearing. There could still be a live round in the chamber for any number of reasons. Make certain that you inspect the chamber to make sure that it is clear.



WARNING

Never touch the trigger when loading or unloading the firearm.

MALFUNCTION WARNING!

If cartridge hangs up, jams or binds when being chambered from magazine into chamber, do not attempt to force it into the chamber by pushing.

DO NOT COVER THE EJECTION PORT WITH YOUR HANDS WHEN LOADING/UNLOADING YOUR FIREARM

1. What to do:

- * **Point firearm in a safe direction while keeping your finger off of the trigger.**

- * Remove magazine.

- * Pull back on charging handle and allow cartridge to fall from firearm.

Do not cover the ejection port with your hands when

- * loading/unloading your firearm.

If cartridge does not fall free, pull charging handle

- * back and lock it in the rear position.

- * Carefully dislodge cartridge.

- * If cartridge cannot be removed, lock bolt carrier back, insert cable lock if possible, carefully store your fire arm and magazines and take it to a competent gun smith or call SDS Imports customer service.

2. Most failures to feed or chamber a cartridge are the result of a damaged magazine, improper firearm handling or defective ammunition.

3. Whatever the cause, a jammed cartridge can be a dangerous situation.



WARNING

Always have firearm pointed in a safe direction. Failure to obey safety information may result in injury to you or others.



Safety and instruction manuals are available from Sds Imports



Always wear eye and ear protection when using any firearm.

TO ELIMINATE MALFUNCTIONS

- First try changing type/brand of ammunition and/or magazine.
- If changing to another type/brand of ammunition and/or magazine does not at once result in smooth feeding of cartridges from magazine to chamber, the following steps should be taken:
- Magazine should be removed first. Check chamber to be sure it and magazine well are clear of cartridges.
- Thoroughly clean magazine, paying particular attention to removing accumulated residue.
- Thoroughly clean breech mechanism of firearm. Use a bristle brush and solvent to remove residue and fouling from breech face, extractor, chamber and feed ramp. (See Detailed Maintenance and Cleaning section for detailed instruction).
- Check that magazine spring tension is adequate; the spring should hold the follower tightly against the lips of the magazine.
- Check that magazine lips are free of nicks and burrs and are not deformed.
- Remove excess oil and solvent from all cleaned components, load magazine and try firearm again.



WARNING

An obstructed, cracked or damaged barrel should never be used and the firearm should be returned to SDS Imports for inspection.

FIELD STRIPPING & CLEANING

NOTE: FIELD STRIPPING PROCEDURES ON THE MAC-5 ARE THE SAME REGARDLESS OF CALIBER. Before performing any cleaning or maintenance, make sure the firearm is completely unloaded (this includes the magazine and chamber).

ALWAYS REMEMBER THE FIREARM IS ABLE TO FIRE WITH OR WITHOUT THE MAGAZINE IN PLACE.

1. Always use proper eye protection when cleaning firearms.
2. POINT GUN IN SAFE DIRECTION WHILE KEEPING FINGER OFF THE TRIGGER.
3. Remove magazine and unload firearm.
4. Fully retract the charging handle then release to completely close the bolt.
5. Rotate safety selector to "SAFE" position (See Page 11).
6. Remove back plate locking pin and remove back plate (Figure 22-1).
7. Remove forward pistol grip locking pin (Figure 22-2) and rotate grip downward to remove (Figure 22-3).



FIELD STRIPPING & CLEANING

8. Grasp recoil spring assembly and pull rearward removing the bolt group and set aside (Figure 23-1).
9. Remove handguard locking pin (Figure 23-2), grasp and pull the front of the handguard downward slightly, and then forward and off the pistol (Figure 23-3).

NOTE: This level of disassembly is all that is required for routine cleaning.

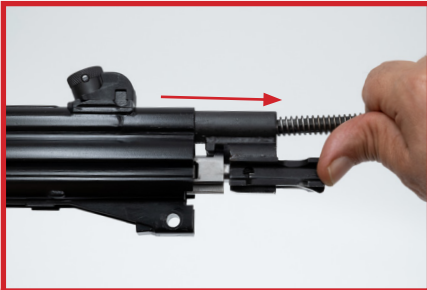

Figure 23-1



Figure 23-2



Figure 23-3

FIELD STRIPPING & CLEANING

BOLT CARRIER GROUP (BCG) CAN BE EASILY DISASSEMBLED FOR MORE DETAILED CLEANING IF NEEDED.

10. Rotate bolt head clockwise 90 degrees (Figure 24-1) and draw the bolt head and locking piece from the carrier.
11. Remove the locking piece and firing pin from the bolt head (Figure 24-2).

NOTE: Do not remove the extractor spring or extractor as doing so requires installing a new extractor spring. BCG disassembly is now complete, no further disassembly is required for routine cleaning. Clean all parts with a quality powder solvent, rinse, dry and inspect. Lightly lubricate the bolt, wipe away any excess lubricant.

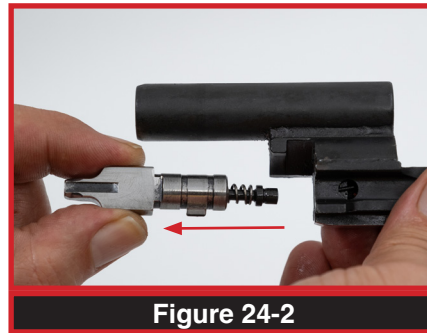
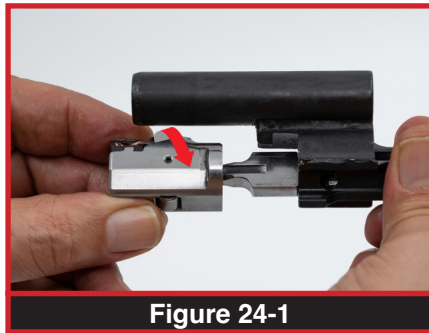

WARNING

If you decide to disassemble your SDS Imports firearm, do so properly. Improper disassembly and/or assembly will create unsafe conditions that could result in injury or death, or a firearm that simply will not work. Don't take chances. Do not attempt to disassemble this or any other firearm until you have received training and instructions from a competent gunsmith.

FIELD STRIPPING & CLEANING

REASSEMBLY OF THE BOLT CARRIER GROUP (BCG)

12. Install the firing pin spring onto the firing pin and insert the pin and spring into the locking piece (Figure 25-1).
13. Insert the locking piece with firing pin and spring into the bolt carrier and orient as shown (Figure 25-2).
14. Install the bolt head with the extractor upwards (Figure 25-3) onto the locking piece.
15. Turn the bolt head counter clockwise until the assembly snaps into place in its correct orientation (Figure 25-3 & 25-4).

BCG reassembly is now complete.

16. Clean the barrel bore and chamber with a quality bore solvent following the manufacturer's instructions.
17. Use a quality powder solvent to clean the carrier way (tunnel) of the receiver and lightly lubricate.
18. Brush or wipe away excessive fouling. Using a quality aerosol cleaning product is a simple method to clean the receiver. Follow the manufacturer's instructions.
19. Lightly oil all exposed metal surfaces of the BCG, receiver carrier way. Wipe away any excessive lubricant.

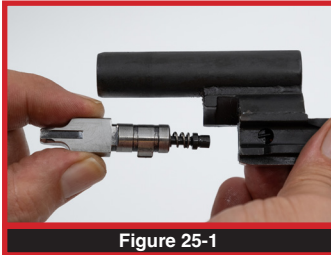

Figure 25-1

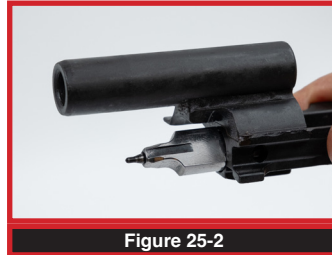

Figure 25-2

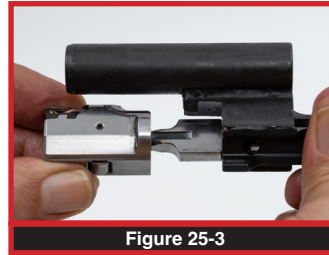

Figure 25-3

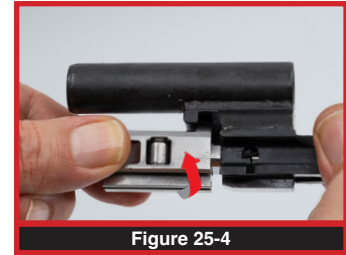

Figure 25-4



WARNING

If you decide to disassemble your SDS Imports firearm, do so properly. Improper disassembly and/or assembly will create unsafe conditions that could result in injury or death, or a firearm that simply will not work. Don't take chances. Do not attempt to disassemble this or any other firearm until you have received training and instructions from a competent gunsmith.

REASSEMBLY

NOTE: REASSEMBLY PROCEDURES ON THE MAC-5 ARE THE SAME REGARDLESS OF CALIBER.



Caution: Never allow live ammunition in the area while you are maintaining your firearms.

1. Install handguard up onto receiver and press reward (Figure 26-1) and install locking pin (Figure 26-2).
2. Install bolt group into receiver from the rear (Figure 26-3).

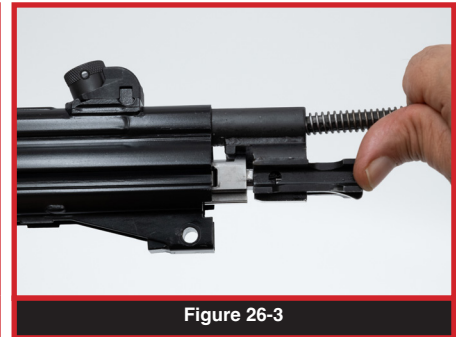

REASSEMBLY

3. Reattach pistol grip and insert front locking pin (Figure 27-4).
4. Insert backplate into receiver and replace locking pin (Figure 27-5). NOTE: Locking pins can be inserted from either side of receiver.



Figure 27-4

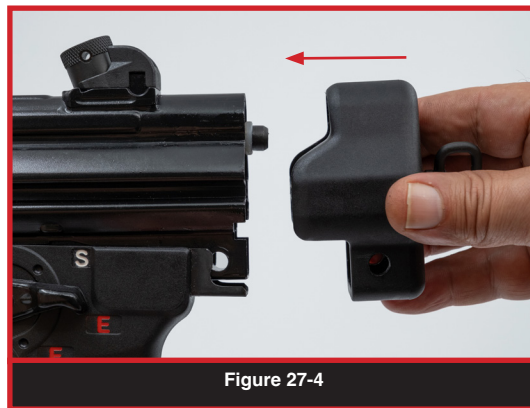
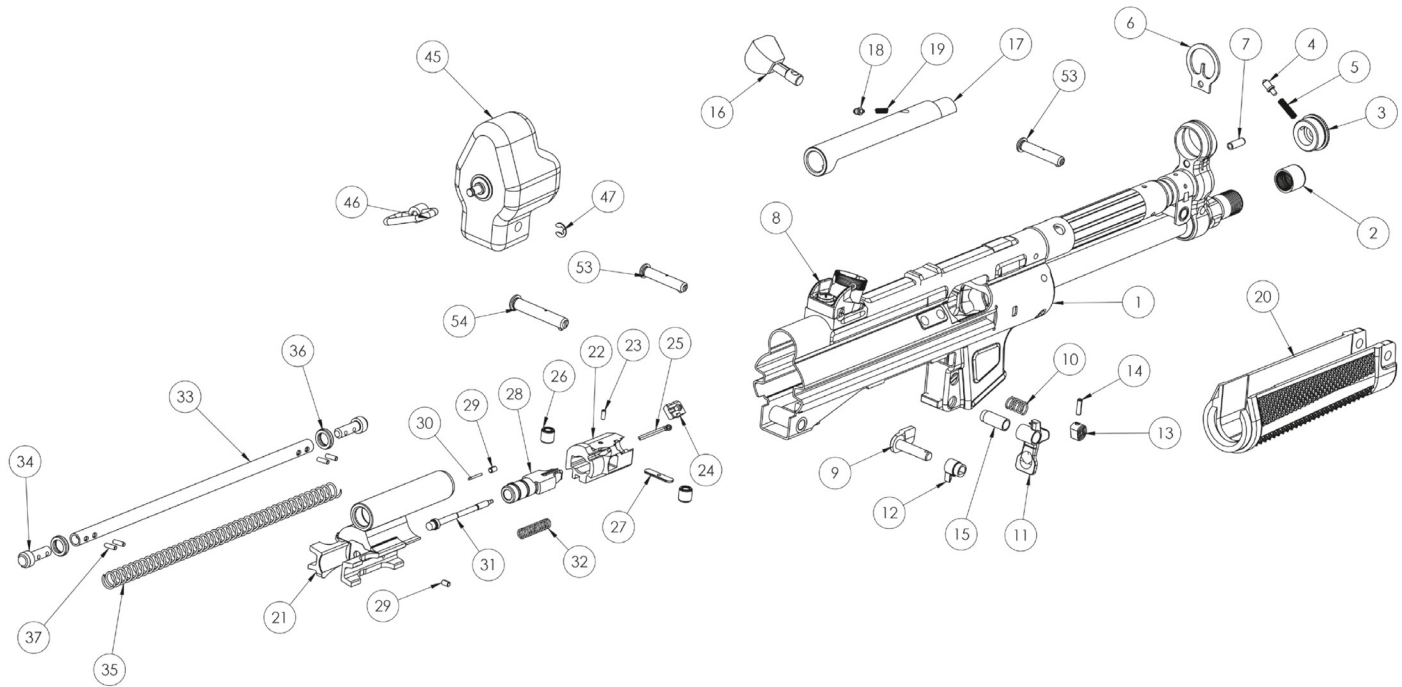

Figure 27-4

MAC-5 PARTS LIST

- | | | | |
|----|--------------------------------|----|-------------------------|
| 1 | Receiver & Barrel Assembly | 22 | Bolt Head |
| 2 | Thread Protector | 23 | Spring Pin |
| 3 | Charging Handle Cap | 24 | Extractor |
| 4 | Detent Pin | 25 | Extractor Spring |
| 5 | Detent Compression Spring | 26 | Locking Roller |
| 6 | Front Sight | 27 | Locking Roller Retainer |
| 7 | Spring Pin | 28 | Locking Piece |
| 8 | Rear Sight Group | 29 | Spring Pin |
| 9 | Magazine Catch | 30 | Stop Pin |
| 10 | Magazine Catch Spring | 31 | Firing Pin |
| 11 | Magazine Release Lever | 32 | Firing Pin Spring |
| 12 | Magazine Catch Contact Piece | 33 | Recoil Spring Guide Rod |
| 13 | Magazine Release Button | 34 | Recoil Spring Stop Pin |
| 14 | Spring Pin | 35 | Recoil Spring |
| 15 | Magazine Release Lever Bushing | 36 | Guide Rod Ring |
| 16 | Charging Handle | 37 | Guide Rod Rivet |
| 17 | Charging Handle Support | 45 | End Cap |
| 18 | Detent Pin | 46 | Sling Ring |
| 19 | Compression Spring | 47 | Retaining Ring |
| 20 | Handguard | 53 | Take-Down Pin 1 |
| 21 | Bolt Carrier | 54 | Take-Down Pin 2 |



View this manual on our website for larger PDF exploded view at www.sdsimports.com

MAC-5 PARTS LIST

- 38 Pistol Grip
- 39 Trigger Housing Assembly
- 40 Safety Spring
- 41 Safety Axle
- 42 Safety Selector
- 43 Safety Bushing
- 44 Safety Selector Spring 48 Magazine Housing
- 49 Locking Plate
- 50 Follower
- 51 Follower Spring
- 52 Magazine Floor Plate

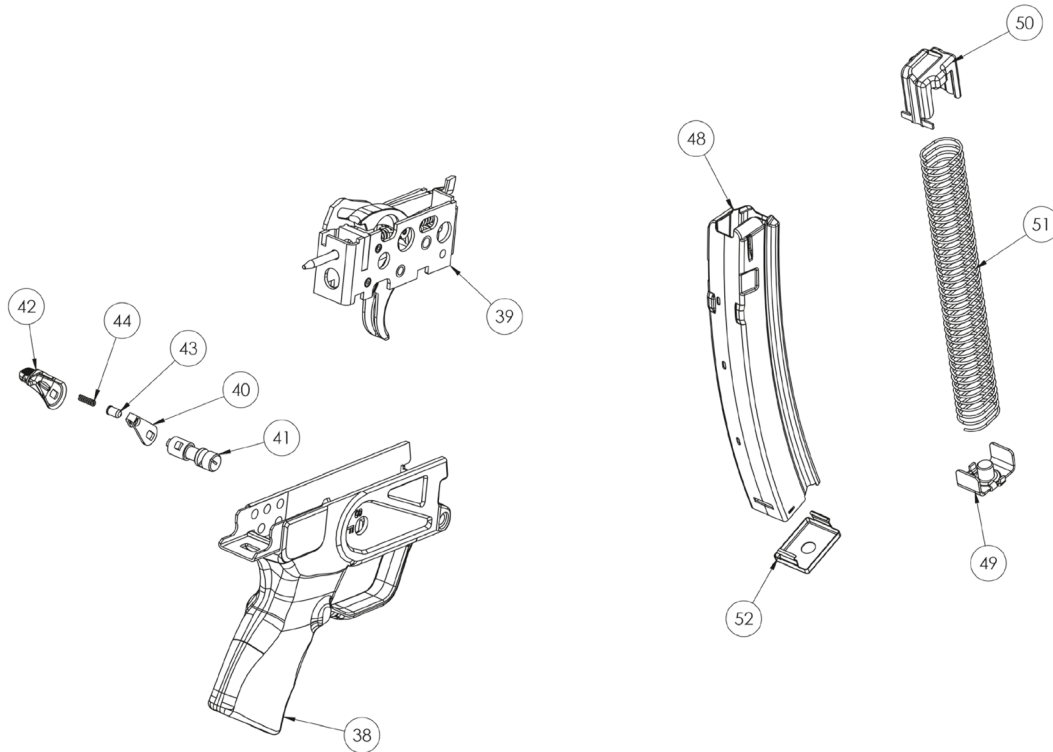

View this manual on our website for larger PDF exploded view at www.sdsimports.com

SIGHT ADJUSTMENT - WINDAGE

Your **MAC 5** is equipped with adjustable sights. The rear sight adjusts the bullet impact horizontally (windage) and vertically (elevation). Elevation is preset at the factory for a 25 yard zero.

There are five apertures on the rear sight. Turn the aperture selector in either direction to your desired setting (Figure 32-1). The smaller diameter apertures are for precision shooting, the larger are for faster target acquisition.

WINDAGE ADJUSTMENT

1. Loosen locking screw 1/2 turn (Figure 32-2).
2. Turn windage adjustment screw clockwise to move point of impact (POI) to the left, turn screw counter-clockwise to move POI to the right (Figure 32-3).
3. Once sights are properly regulated tighten locking screw.

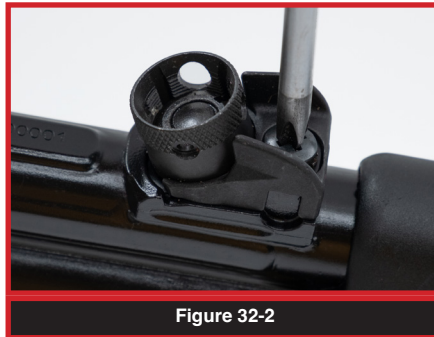
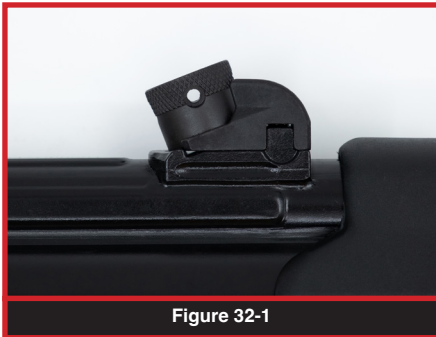

SIGHT ADJUSTMENT - ELEVATION

ELEVATION ADJUSTMENT

The rear sight elevation may be manipulated using long nose pliers (The ends of the pliers may require modification to properly fit the slots).

1. Insert the pliers into the rear sight drum so that the tips engage the two slots in the drum that contain the locking detents (Figure 33-1).
2. Squeeze the pliers to compress the detents which will allow the drum to rotate (Figure 33-2).
3. Hold the pliers securely and rotate the drum to the desired elevation setting in 1/4 turn increments (Figure 33-3).

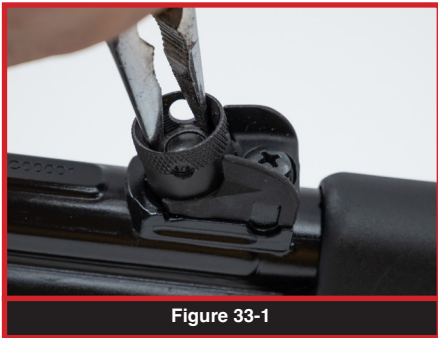

MILITARY ARMAMENT CORP WARRANTY

MAC-5 LIMITED LIFETIME WARRANTY

This Limited Warranty is issued by SDS Imports, Inc., d/b/a SDS Imports ("SDS Imports "we" or "us" or "our") to "You" the original retail purchaser (also "YOUR") of a SDS Imports (the "Product"). This Limited Warranty gives You specific legal rights, and You may also have other rights which vary from state to state.

WHO AND WHAT IS COVERED BY THIS WARRANTY?

SDS Imports, Inc. warrants to You, the original retail purchaser of the Product, that the Product You purchased will be free of defects in workmanship or material, subject to the terms of this document.

HOW LONG WILL THIS WARRANTY LAST?

This Warranty will be in effect the time that YOU, the original retail purchaser, own the product. Proof of original purchase required

WHAT DO YOU HAVE TO DO FOR WARRANTY SERVICE?

You must take 3 steps to get warranty service. Notify us by phone, email, fax, or mail. If You discover a defect in material or workmanship, You must notify us by telephone, email, fax or mail at once of the Warranty Service Contact Points. Warranty Service

Contact Points: SDS Customer Service

Telephone: (865) 604-6894

Email: info@milarmamentcorp.com

Mail: 114 Sherlake Lane Suite 18 Knoxville TN 37922

Attn : Warranty Service

Write a brief description of the defect. Please write down a brief description of the defect and how YOU experienced or discovered the defect. Follow the return instructions you receive from SDS Imports Once we receive Your notification for warranty notice at one of our Warranty Service Contact Points, we will provide You with a shipping coupon (so that we can pay for the shipping) and instructions on how to return Your Product for service. You must follow the shipping instructions once You receive them.

WHAT WILL SDS IMPORTS DO IF YOU DISCOVER A DEFECT?

If, during YOUR ownership of the Product, one or more parts of the Product fail due to defects in materials or workmanship, SDS Imports will provide, free of charge, a new, repaired or reconditioned (decided at our discretion) Product. That new, repaired or reconditioned Product will be warranted for the remainder of YOUR ownership of the Product under these terms and conditions

WHAT IS NOT COVERED BY THIS LIMITED WARRANTY?

This Limited Warranty does not cover any damage or condition determined by SDS Imports to be caused by: unauthorized repairs, disassembly, adjustments or modifications, carelessness, negligence, misuse, or unsafe handling, normal wear and tear, failure to properly or reasonably store, use, or maintain the product, hand-loaded, reloaded, UHEDDFWUHG, or defective ammunition.



WARNING

The MAC-5, like all firearms, is a dangerous weapon if not handled properly.

LIMITATION OF LIABILITY AND DISCLAIMERS

This limited warranty is provided in lieu of any and all express warranties. All implied warranties, including implied warranties of merchantability, non-infringement and fitness for a particular purpose, are limited in duration to the duration of the warranty period (the original purchaser's (your) ownership of the product) and no warranties, whether express or implied, will apply after such period.

Some states do not allow limitations on the duration of an implied warranty, so the above limitation may not apply to you. SDS Imports responsibility for malfunctions and defects in the product is limited to the terms set forth in this limited warranty. The preceding limited warranty constitutes SDS Imports only obligation to you and represents your exclusive remedy against SDS Imports. In no event will SDS Imports be liable for incidental, special or consequential damages, regardless of whether your claims are based on breach of contract, tort (including negligence and strict liability) or other theories, including, without limitation, any liability for economic loss, bodily injury, property damage or for any damage that may result from your use or ownership of the product, whether foreseeable or not. Some states do not allow the exclusion or limitation of incidental or consequential damages or certain other exclusions contained in warranties, so the above limitations or exclusions may not apply to you. The limitations set forth in this limited warranty shall not apply to the extent that they are prohibited by law.

No person or entity is authorized to give any other warranty or to assume any other obligation on behalf of SDS Imports. Any provision of this Limited Warranty prohibited or unenforceable in any jurisdiction shall be ineffective only to the extent of such prohibition and shall not invalidate any of the remaining provisions of this Limited Warranty.

GOVERNING LAW/VENUE/CONSENT TO JURISDICTION

This Limited Warranty will be governed and construed in accordance with the law Any litigation between SDS IMPORTS and YOU or YOUR heirs, representatives or assigns shall be filed before a court of competent jurisdiction and venue in the Knoxville.

KEEP THIS CARD FOR YOUR RECORDS

Serial Number

Date Of Purchase

Place Of Purchase



Safety and instruction manuals are available from SDS Imports, Inc.



Always wear eye and ear protection when using any firearm.

DOWNLOAD THIS MANUAL ON OUR WEBSITE:

WWW.MILARMAMENTCORP.COM Always check website for update versions of operation & safety manuals COPYRIGHT MILITARY ARMAMENT CORP 2024