

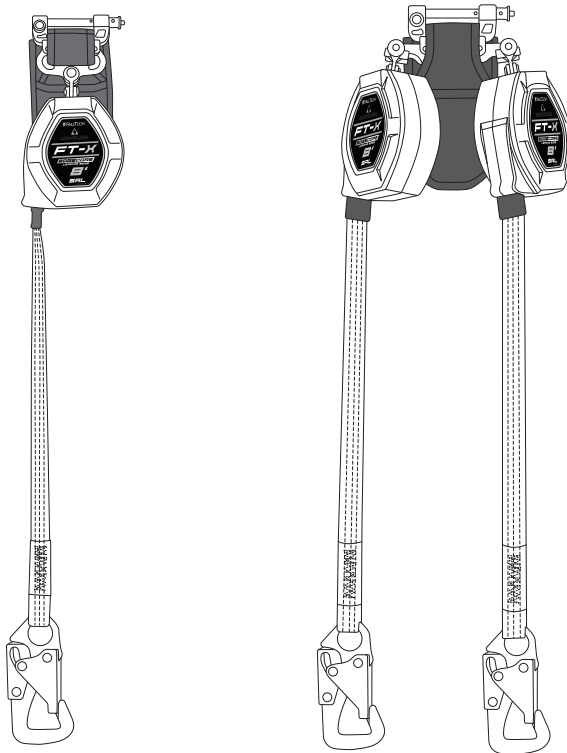

## User Instruction Manual

# 8' FT-X™ EdgeCore™ Arc Flash Tie-Back Class 2 Leading Edge SRL-P



This manual is intended to meet the Manufacturer's Instructions as required by the American National Standards Institute (ANSI) Z359 and should be used as part of an employee training program as required by the Occupational Safety and Health Administration (OSHA).

FallTech © 2023

1306 South Alameda Street Compton, CA 90221, USA

1-800-719-4619 • 1-323-752-0066

[www.FallTech.com](http://www.FallTech.com)

## Table of Contents

1.0 Warnings and Important Information .....	3
2.0 Description .....	4
3.0 Application .....	6
4.0 System Requirements.....	7
5.0 Installation and Use .....	8
6.0 Maintenance, Service, and Storage.....	14
7.0 Inspection.....	15
8.0 Labels.....	18
9.0 Definitions.....	19

For purposes of this manual, the 8' FT-X™ EdgeCore™ Arc Flash Tie-Back Class 2 Leading Edge SRL-P in all iterations may be referred to collectively as the 8' FT-X, the FT-X, the FT-X EdgeCore, the FT-X EdgeCore Arc Flash the SRL-P, the leading edge SRL, the tie-back SRL, the SRL, the SRD, the equipment, the device, the product, or the unit.

Throughout this manual, ANSI Z359.0-2012 fall protection words, phrases and terms are used. These terms are all formally defined in Section 9 of this manual.

Any non-English translations of this user instruction manual are for reference only.

## 1.0 Warnings and Important Information

### **WARNING**

- Avoid moving machinery, thermal, electrical, and/or chemical hazards as contact may cause serious injury or death.
- Avoid swing falls.
- Follow the weight restrictions and recommendations in this manual.
- Remove from service any equipment subjected to fall arrest forces.
- Remove from service any equipment that fails inspection.
- Do not alter or intentionally misuse this equipment.
- Consult FallTech when using this equipment in combination with components or subsystems other than those described in this manual.
- Do not connect rebar hooks, large carabiners, or large snap hooks to the FBH dorsal D-rings as this may cause a roll-out condition and/or unintentional disengagement.
- Use caution when performing arc welding. Arc flash from arc welding operations, including accidental arcs from electrical equipment, can damage equipment and are potentially fatal.
- Examine the work area. Be aware of the surroundings and workplace hazards that may impact safety, security, and the functioning of fall arrest systems and components.
- Hazards may include, but are not limited to, cable or debris tripping hazards, equipment failures, personnel mistakes, or moving equipment such as carts, barrows, fork lifts, cranes, or dollies. Do not allow materials, tools, or equipment in transit to contact any part of the fall arrest system.
- Do not work under suspended loads.

### **IMPORTANT**

This product is part of a personal fall arrest, restraint, work positioning, suspension, or rescue system. A Personal Fall Arrest System (PFAS) is typically composed of an anchorage and a Full Body Harness (FBH), with a connecting device, i.e., a Shock Absorbing Lanyard (SAL), or a Self-Retracting Lanyard (SRL), attached to the dorsal D-ring of the FBH.

These instructions must be provided to the worker using this equipment. The worker must read and understand the manufacturer's instructions for each component or part of the complete system. Manufacturer's instructions must be followed for proper use, care, and maintenance of this product. These instructions must be retained and be kept available for the worker's reference at all times. Alterations or misuse of this product, or failure to follow instructions, may result in serious injury or death.

A Fall Protection Plan must be on file and available for review by all workers. It is the responsibility of the worker and the purchaser of this equipment to assure that users of this equipment are properly trained in its use, maintenance, and storage. Training must be repeated at regular intervals. Training must not subject the trainee to fall hazards.

Consult a doctor if there is reason to doubt your fitness to safely absorb the shock of a fall event. Age and fitness seriously affect a worker's ability to withstand falls. Pregnant women or minors must not use this equipment.

ANSI limits the weight of fall protection equipment users to a maximum of 310 lbs. Products in this manual may have a rated capacity exceeding ANSI capacity limits. Heavy users experience more risk of serious injury or death due to falls because of increased fall arrest forces placed on the user's body. In addition, the onset of suspension trauma after a fall event may be accelerated for heavy users.

The user of the equipment discussed in this manual must read and understand the entire manual before beginning work.

**NOTE:** For more information consult the ANSI Z359 body of standards.

## 2.0 Description

The 8' FT-X™ EdgeCore™ Arc Flash Tie-Back Class 2 Leading Edge SRL-P is a self-retracting device for those working at height and may be subject to fall hazards, including leading edge hazards. This manual includes one Appendix containing figures and tables specific to the FT-X™ EdgeCore™ Arc Flash Tie-Back SRL-P discussed in this manual.

FallTech Arc Flash SRLs have been tested to meet the requirements of ASTM F887 and OSHA 1910.269 requiring a capacity to maintain flame resistance during an electric arc with a heat energy of up to  $40 \pm 5$  cal/cm<sup>2</sup>. Please refer to the table in Appendix A of this supplement for specific part numbers and specifications.

The SRL discussed in this manual may be attached to or around an overhead anchorage, i.e., from directly over the user's head, or to or around an anchorage at a maximum of 5' (1.5 m) below the user's FBH dorsal D-ring.

Leading edge means the unprotected side and edge of a floor, roof, or form work for a floor or other walking/working surface (such as deck) which changes location as additional floor, roof, decking, or form work sections are placed, formed, or constructed; see Figure 1.

As shown in Figure 2 below, the FT-X EdgeCore Arc Flash Tie-Back has a nylon housing that contains a synthetic lifeline wound onto a spring tensioned drum. The FT-X EdgeCore Arc Flash lifeline is equipped with a lifeline stop and a leg-end connector. When the user is attached, the lifeline extends and retracts with the user movement, automatically maintaining taut lifeline. If a fall occurs, a centrifugal pawl system engages, stopping the lifeline payout. In a fall event, the SRL-FBH Connector will break away from the Shear Connector, and the integral Energy Absorber (EA) will deploy, gradually slowing and arresting the fall.

The FT-X EdgeCore Arc Flash Tie-Back may be connected directly to anchorages with the leg-end carabiner or may be connected with the leg-end carabiner connecting back onto the lifeline itself around the anchorage. See Figure 3 for visual representation and Section 5.3 for requirements.

See Table 1A in Appendix A for product, material, and performance specifications.

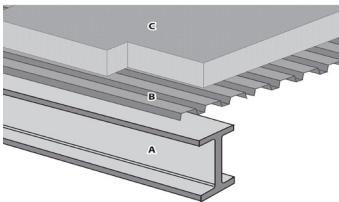

Figure 1 - Typical Extreme Sharp Edges	
<b>A</b>	Structural Steel I-Beams and Purlins
<b>B</b>	Structural Steel I-Beams and Purlins
<b>C</b>	Poured/Precast Concrete and Concrete Block

Examples not intended to depict the full extent of all hazardous sharp edges found on job sites.

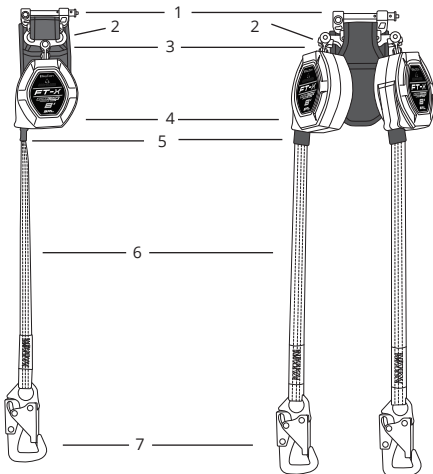
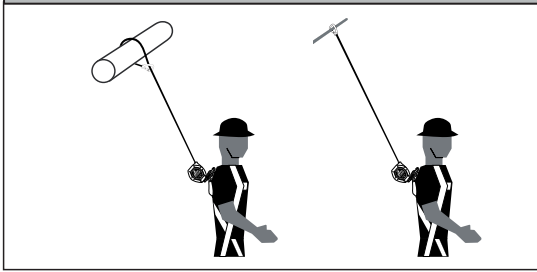

Figure 2 - About the 8' FT-X™ EdgeCore™ Arc Flash Tie-Back Class 2 Leading Edge SRL-P	
<b>1</b>	SRL-FBH Connector
<b>2</b>	Energy Absorber
<b>3</b>	Connector Assembly
<b>4</b>	Housing
<b>5</b>	Lifeline Stop
<b>6</b>	Synthetic Lifeline
<b>7</b>	Snap Hook

Figure 3 - FT-X EdgeCore Arc Flash Tie-Back  
Acceptable Anchorage Connections



## 2.1 American National Standards Institute (ANSI) and Occupational Safety and Health Administration (OSHA):

The SRD discussed in this manual meets the standards of ANSI Z359.14-2021, ANSI A10.32-2012, and Occupational Safety and Health Administration (OSHA) regulations 1926.502 and 1910.140. ANSI requires SRDs be classified according to the type of usage the user would be exposed to, and are tested either as Class 1 or Class 2. Dynamic performance means that the SRD is installed in a testing drop tower. A test weight is attached to the SRD and then dropped. Test results are recorded.

Parameters recorded are:

- Arrest Distance (AD)
- Average Arrest Force (AAF)
- Maximum Arrest Force (MAF)

The Arrest Distance is the total vertical distance required to arrest a fall. The Arrest Distance includes the deceleration distance and the activation distance. The Average Arrest Force is the average of the forces applied to the body and the anchorage by the fall protection system. The Maximum Arrest Force is the maximum amount of force that may be applied to the body and the anchorage by the fall protection system. In addition to the above tests conducted in ambient conditions, the units must be for average and peak forces under certain environmental conditions, where the units are cooled, then tested, heated, then tested, or saturated in water and tested again. Separate units may be used for each test. All test results are recorded.

This test data is then used to establish the basis for fall clearance guidelines published in the user instruction manual.

Class 1 and 2: Class 1 devices shall be used only on overhead anchorages and shall be subjected to a maximum free fall of 2 feet (0.6 m) or less. Class 2 devices are intended for applications where an overhead anchorage may not be available or feasible and be subjected to a free fall of no more than 6 feet (1.8 m) over an edge.

To be declared a Class 1 and Class 2 device, ANSI requires an SRD to have an overhead Arrest Distance of less than 42" (1.1 m), an Average Arrest Force of less than 1,350 lbs (6 kN) [1,575 lbs (7 kN) conditioned] and a Maximum Arresting Force of 1,800 lbs (8 kN), for both ambient and conditioned testing.

When dynamically tested in accordance with requirements of ANSI Z359.14-2021, FallTech Class 1 and Class 2 Self-Retracting Devices have an AAF of 1,350 lbs (6 kN) or less and an AD of less than 42" (1.1 m).

**Please see Section 5 of this user instruction manual for how to calculate your Minimum Required Fall Clearance (MRFC).**

Class 2 SRL-P's shall include a label illustrating the fall clearance required when using the device. This label shall be affixed to the product. The 8' FT-X EdgeCore Arc Flash Tie-Back Class 2 SRL-P includes this label in the energy absorber cover.

**Please see Section 5.2 of this user instruction manual for how to calculate your Minimum Required Fall Clearance (MRFC) using the affixed labels.**

Classification information found on product labels is based on test results. Table 1B in Appendix A provides test performance results for the SRD discussed in this manual. **NOTE:** Arrest distance is one of several parts of the Minimum Required Fall Clearance (MRFC). MRFC is discussed in detail in Section 5 .

OSHA requires an SRD limit the free fall to 2 feet (0.9 m) or less. If the maximum free fall distance must be exceeded, the employer must document, based on test data, that the maximum arresting force will not be exceeded, and the personal fall arrest system will function properly. The SRD discussed in this manual was successfully tested for horizontal use and falls over a steel edge without burrs, as found on steel shapes and metal sheeting, and may be used in situations where a fall may occur over similar edges, such as found on steel shapes or metal sheeting. Additional testing has been conducted on a concrete edge substrate, outside and beyond the scope of ANSI Z359. Contact Falltech for more information on this testing.

### 3.0 Application

#### 3.1 Purpose:

The 8' FT-X™ EdgeCore™ Arc Flash Tie-Back Class 2 Leading Edge SRL-P is designed to be used as a component in a Personal Fall Arrest System (PFAS), to provide a combination of worker mobility and fall protection as required for inspection work, general construction, maintenance work, oil production, confined space work, etc. The FT-X™ EdgeCore™ Arc Flash Tie-Back SRL-P may be used as fall protection in Leading Edge applications where falls may occur over leading edges.

#### 3.2 Personal Fall Arrest System:

A PFAS is an assembly of components and subsystems used to arrest a person during a fall event. A PFAS typically consists of an anchorage, a deceleration device such as a Energy Absorbing Lanyard (EAL), a Self-Retracting Device (SRD), or a Fall Arrestor Connecting Subsystem (FACSS), and a properly fitted Full Body Harness (FBH). The SRD discussed in this manual may be used in non-overhead anchorage situations. Maximum permissible free fall in a typical PFAS is 6' (1.8 m). Other applications may be below the D-ring, or horizontally in an approved FallTech SRL rotating anchor, designed for such use.

#### 3.3 Horizontal Lifeline (HLL) and Rail Systems:

The SRL may be attached to rigid and flexible anchors provided that all HLL or rail system applications, installation, and uses are under the supervision of a Qualified Person.

#### 3.4 Rescue:

Ensure a written rescue plan, method, and system is in place and readily available for rapid response. Rescues may require specialized equipment or measures. Rescue operations are beyond the scope of this manual. See ANSI Z359.4.

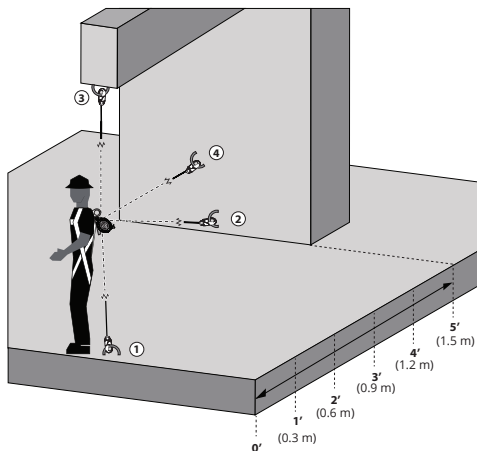

Figure 4 - Anchorage Locations	
1	Anchorage of SRD at Foot Level with 0' Setback from Leading Edge
2	Anchorage of SRD at Foot Level with 5' Setback from Leading Edge
3	Overhead Anchorage of SRD Above Dorsal D-Ring
4	Anchorage of SRD Above Dorsal D-Ring with 5' Setback from Leading Edge

### **3.5 Application Limits:**

Take action to avoid moving machinery, abrasive surfaces, and thermal, electrical, including the arc from welding applications, and chemical hazards as contact may damage the SRL, which may result in serious injury or death. The SRL is not designed for use in restraint, personnel riding, suspension, or work positioning. Rescue applications are beyond the scope of this manual. Do not use the SRL for these applications except as a back-up PFAS.

## **4.0 System Requirements**

### **4.1 Capacity:**

The 8' FT-X™ EdgeCore™ Tie-Back Class 2 Leading Edge SRL-P is designed for use by a single user with a combined weight of user, tools, clothing, etc., of:

- a. 130 - 310 lbs. (59 - 141 kg) to comply with ANSI and OSHA
- b. 130 - 420 lbs. (59 - 191 kg) to comply with OSHA only

### **4.2 Compatibility Of Connectors:**

Connectors are considered to be compatible with connecting elements when they have been designed to work together in such a way that their sizes and shapes do not cause their gate mechanisms to inadvertently open regardless of how they become oriented. Contact FallTech if you have any questions about compatibility. Connectors must be compatible with the anchorage or other system components. Do not use equipment that is not compatible, see Figure 5. Non-compatible connectors may unintentionally disengage. Connectors must be compatible in size, shape, and strength. Self-closing, self-locking connectors are required by ANSI and OSHA.

### **4.3 Compatibility Of Components:**

Equipment is designed for use with approved components and subsystems only. Substitutions or replacements made with non-approved components or subsystems may jeopardize compatibility of equipment and may affect the safety and reliability of the complete system.

### **4.4 Making Connections:**

Only use self-locking connectors with this equipment. Only use connectors that are suitable to each application. Ensure all connections are compatible in size, shape, and strength. Do not use equipment that is not compatible. Visually ensure all connectors are fully closed and locked. Connectors are designed to be used only as specified in each product's user instructions.

### **4.5 Personal Fall Arrest System:**

A PFAS is an assembly of components and subsystems used to arrest a person during a fall event. A PFAS is typically composed of an anchorage and a FBH, with an energy absorbing connecting device, i.e., an SAL, an SRL, or a Fall Arrester Connecting Subsystem (FACSS), connected to the dorsal D-ring of the FBH. PFAS components used in conjunction with this SRL should comply with ANSI Z359 requirements and applicable OSHA regulations.

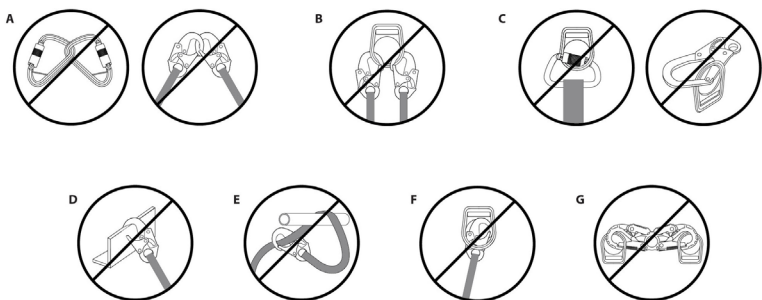

**Figure 5 - Non-Compatible Connections**

<b>Figure 5 - Non-Compatible Connections</b>	
<b>A</b>	Never connect two active components (snap hooks or carabiners) to each other.
<b>B</b>	Never connect two active components (snap hooks or carabiners) to a single D-ring at the same time.
<b>C</b>	Never connect in a way that would produce a condition of loading on the gate.
<b>D</b>	Never attach to an object in a manner whereby the gate (of the snap hook or carabiner) would be prevented from fully closing and locking. Always guard against false connections by visually inspecting for closure and lock.
<b>E</b>	Never attach explicitly to a constituent subcomponent (webbing, cable or rope) unless specifically provided for by the manufacturer's instructions for both subcomponents (snap hook or carabiner and webbing, cable, or rope).
<b>F</b>	Never attach in a manner where an element of the connector (gate or release lever) may become caught on the anchor thereby producing additional risk of false engagement.
<b>G</b>	Never attach a spreader snap hook to two side/positioning D-rings in a manner whereby the D-rings will engage the gates; the gates on a spreader must always be facing away from the D-rings during work positioning.

#### 4.6 Average Arrest Force and Arrest Distance:

Table 1B in Appendix A provide test data on typical performance attributes of the three principal parameters: Arrest Distance, Average Arrest Force, and Maximum Arrest Force, listed by model number and class. Testing is conducted under various environmental conditions, at ambient temperature, hot, cold, and wet conditions. In manufacturer's tests, worst case performance attributes of the SRL, connected 5' below dorsal D-ring in a Leading Edge application are:

<b>5' Below D-Ring, Leading Edge</b>	<b>130 to 310 lbs. (59 to 141 kg)</b>	<b>130 to 420 lbs. (59 to 191 kg)</b>
Longest Arrest Distance	122" (3.1 m)	155" (3.9 m)
Largest Average Arrest Force	830 lbs (3.7 kN)	780 lbs (3.4 kN)
Largest Maximum Arrest Force	1,618 lbs (7.2 kN)	1,246 lbs (5.5 kN)

The Competent Person may find this data useful with planning anchorage location and calculating fall arrest loads and distances from the walking/working level to the nearest obstruction or lower level. See Section 5.

**NOTE:** Arrest distance is one part of the Minimum Required Fall Clearance (MRFC). The MRFC is determined by consideration of multiple factors in fall protection. Attachment below the level of the FBH D-ring will require additional fall clearance. MRFC is discussed in detail in Section 5.

#### 4.7 Personal Fall Arrest System Anchorage Strength:

An anchorage selected for PFAS application must have the strength to sustain a static load applied in the direction permitted by the PFAS of at least:

- Two times the maximum arrest force permitted when certification exists, or
- 5,000 lbs. (22.2 kN) in the absence of certification.

Select an anchorage location carefully. Consider structural strength, obstructions in the fall path, and swing fall hazards. In certain situations, the qualified person can determine that a given structure is able to withstand the applied MAF of the PFAS with a safety factor of at least two, as required by OSHA.



## 5.0 Installation and Use

### WARNING

Do not alter or intentionally misuse this equipment. Consult FallTech when using this equipment in combination with components or subsystems other than those described in this manual. All components or subsystems used with the SRD discussed in this manual must be in compliance with ANSI Z359 and/or OSHA.

Do not use rebar hooks, large carabiners or large snap hooks to connect to the FBH dorsal D-rings or to any small diameter non-compatible anchor point as this may cause a roll-out condition and/or unintentional disengagement.

### 5.1 Installation to Full Body Harness

Installation for both Single-leg and Twin-leg configurations of the 8' FT-X™ EdgeCore™ Arc Flash Tie-Back Class 2 Leading Edge SRL-P follow the same steps listed below:

**Step 1:** On the FBH, lift the dorsal D-ring to the up-pointing position, then loosen the intersection of the two web straps that pass through the D-ring slot to create slacked loops of about 2" as shown in Figure 6A. Note that some harnesses may have a built-in tunnel.

**Step 2:** Depress both release buttons and slide the locking bar into the open position as shown in Figure 6B.

**Step 3:** Attach the connector to the slacked loops by inserting the locking bar through the slacked loops as shown in Figure 6C.

**Step 4:** Make sure the locking bar is in the fully inserted and in the locked position, see Figure 6D.

Figure 6 - FT-X™ EdgeCore™ Arc Flash Tie-Back Class 2 Leading Edge SRL-P Installation

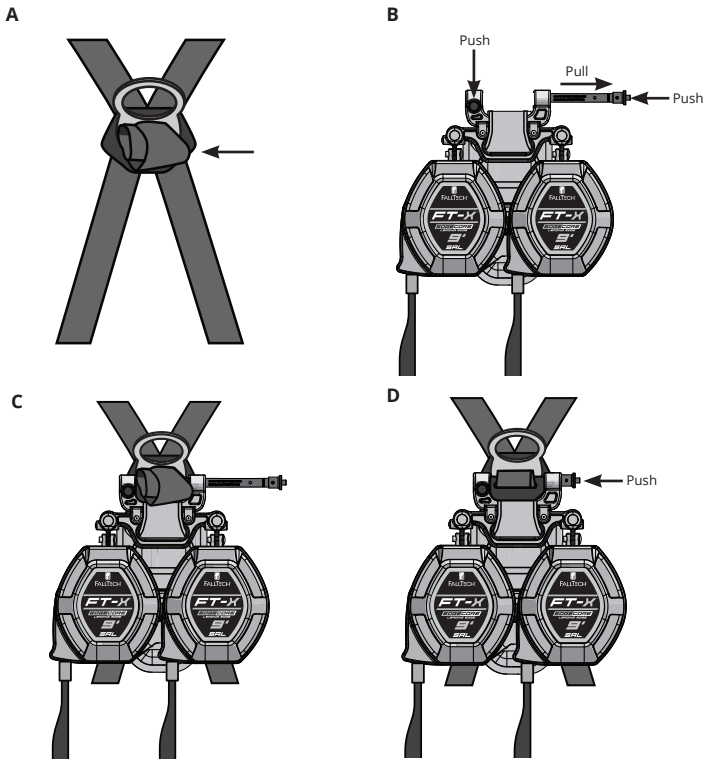

## 5.2 Attaching to an Anchorage

Examine the work area for possible hazards. Take caution to avoid overhead hazards such as cranes, poles, overhead power cables, and walking/working surface hazards such as power cables, welding leads, air and fluid hoses, including obstruction hazards such as vertical columns and stacks of materials on the lower level. Eliminate hazards where possible.

Ensure the anchorage provides the Minimum Required Fall Clearance (MRFC) in the fall path below the walking/working surface to prevent striking the lower level or an obstruction during a fall event. Take action to avoid swing falls, which occur when the anchorage is not directly above the point where the fall occurs.

Fall clearance and swing falls are subject to variable conditions. Anchor height, lateral movement, and setback distance all affect anchor location with regard to fall clearance and swing falls.

The SRL may be attached to an overhead anchor, i.e., above the user's FBH dorsal D-ring, or a non-overhead anchor, i.e., below the user's FBH dorsal D-ring. A non-overhead anchor may be a maximum of 5' (1.5 m) below the user's FBH dorsal D-ring. Non-overhead anchor locations result in greater contact between the lifeline and the edge and present greater abrasion risk hazards.

Use of a below D-ring anchorages should be as a last resort, when no other anchor option exists.

Performance testing has shown that a fall event over a leading edge will alter SRL performance characteristics and fall clearance requirements. When anchored below the FBH back D-ring, fall events will result in greater fall clearances. Reduced setback distances will also increase clearance requirements. Non-overhead anchorage when the SRL is set back less than 5' (1.5 m) will result in the greatest MRFC and the least amount of worker mobility due to swing fall. Greater set back distances of 5' (1.5 m) or more will reduce the overall MRFC and allow for more lateral movement of the worker when attached to a non-overhead anchorage.

If job site geometry allows it, a setback distance of 5' (1.5 m) is recommended to take full advantage of the SRL performance. In addition, the Angle of Redirection of the lifeline, i.e., the angle of the lifeline as it passes over the edge, must be at 90 degrees or more, never less, see Figure 7.

Do not attach the anchorage connector in a manner that places the edge higher than the connector, see Figure 7.

**Figure 7 - Leading Edge Angle of Lifeline Redirect**

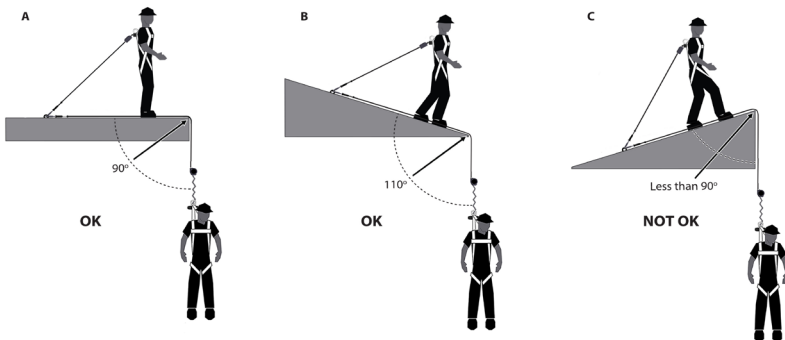

## 5.3 Attaching to an Anchorage - Tie-Back Applications

For applications that require the SRL-P to be tie-back onto itself around the appropriately rated anchorage, the anchorage may also be overhead or up to a maximum of 5' (1.5 m) below the user's FBH dorsal D-ring. The lifeline shall only pass through the leg-end tie-back carabiner one time and the carabiner shall fully close around the lifeline that is wrapped around the anchorage. There is no limit to anchorage size so long as the carabiner can fully close around the anchorage.

#### 5.4 Using the 8' FT-X™ EdgeCore™ Arc Flash Tie-Back Class 2 Leading Edge SRL-P

Before each use, inspect the FT-X™ EdgeCore™ Arc Flash Tie-Back in accordance with Section 7. Remove the device from service if the inspection shows damage or any malfunction.

Don the FBH (with the FT-X™ EdgeCore™ Arc Flash Tie-Back attached) in accordance with the harness manufacturer's instructions. Follow the instructions contained in this manual and on the labels. Failure to follow instructions may result in serious injury or death.

Connect the leg end connector to an approved anchorage point. Ensure the connector closes and locks. In a Twin-leg configuration, attach the unused leg end connector to the FBH's lanyard keeper. Ensure all connections are compatible. Normal operation will allow the working length of the lifeline to extend and retract as the worker moves about. When using a Twin-leg configuration, it is possible to move laterally between anchor points with 100% tie-off as shown in Figure 8.

**Figure 8 - Twin-Leg SRL-Ps for Lateral Movement**

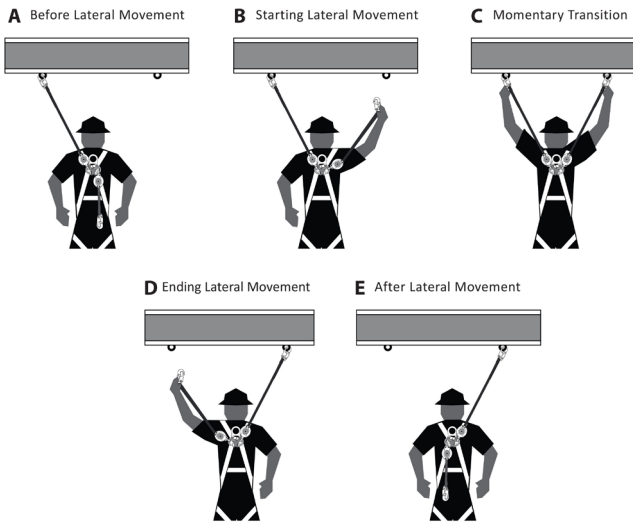

Avoid sudden or quick movements during the normal work operation, as this may cause the SRL pawl system to engage and possibly cause loss of balance, which may cause injury or death. If a fall occurs, the pawl system will engage and lock the lifeline. The EA will deploy to arrest the fall and limit arrest forces on the user.

##### 5.4.1 Locking Mechanism:

The SRD utilizes an acceleration based locking mechanism. The locking function requires a certain payout rate during a fall event to function correctly. Certain situations, confined or cramped spaces, shifting footing such as sand, gravel, grain, or a sloped surface may not allow the lifeline to reach sufficient speed to activate the lock mechanism. A clear path is required to assure positive locking of the SRD. Ensure the lock is functioning properly. Pull the lifeline out a short distance and give it a sharp tug. The lifeline must lock. If it fails to lock, remove it from service immediately. Ensure the work zone remains within stated parameters. Beware of Leading Edge hazards.

##### 5.4.2 Visual Indicator:

The primary visual indicator is the shear connector. The shear connector halves will separate if the SRL-P has been subjected to fall arrest forces, as shown in Figure 9, Image B. If the shear connector is separated, remove the unit from service. For deployed visual indicators, both SRDs and the energy absorber shall be removed from service and destroyed. SRD units shall not be salvaged and re-used with other energy absorber(s).

Figure 9 - Visual Indicator

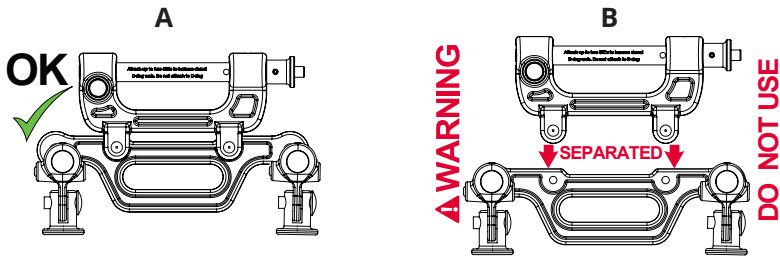

#### 5.4.3 After A Fall:

A fall event over an edge may require special rescue equipment and measures. Ensure a written rescue plan, method and system is in place and readily available to all users for rapid response. Ensure all users are trained in rescue procedures. If a fall event occurs, remove it from service, and store it separately. Remove from service any unit that has been subjected to fall arrest forces or that exhibits damage consistent with such forces. For questions, contact FallTech.

#### 5.4.4 Using the SRD:

Do not use the SRD if inspection shows damage or any malfunction. Don the FBH in accordance with the FBH manufacturer's instructions. Follow the instructions contained in this manual and on the labels. Failure to follow instructions may result in serious injury or death. Connect the SRL-FBH Connector to the dorsal D-ring on the FBH. Ensure the connector closes and locks. Attach the leg-end carabiner to the chosen anchorage and ensure the leg-end connector closes and locks. Ensure all connections are compatible. Normal operation will allow the working length of the lifeline to extend and retract as the worker moves about. A certain amount of tension must remain on the cable at all times to ensure proper operation of the internal brake. Do not allow the lifeline to become slack. If the lifeline becomes slack, remove the SRD from service for inspection. See Section 7.

Avoid sudden or quick movements during the normal work operation, as this may cause the SRD brake to engage and possibly cause loss of balance and injury or death.

If a fall occurs, the brake will engage and lock the lifeline. The EA will deploy to arrest the fall and limit arrest forces on the user.

- DO NOT extend the lifeline past the operational limit.
- DO NOT allow one SRD lifeline to become tangled or twisted with another SRD lifeline during use.
- DO NOT allow any lifeline to pass under arms or between legs during use.
- DO NOT clamp, knot, or prevent the lifeline from retracting or being taut.
- DO NOT lengthen the SRD by connecting a lifeline or similar component.
- DO NOT allow the lifeline to remain outside the housing when not in use.

### 5.5 Calculating Minimum Required Fall Clearance

#### 5.5.1 FT-X in Overhead, Non-Leading Edge Anchorage Application [130 to 310 lbs. (59 to 141 kg) user]

The FT-X may be used as a standard SRD in an overhead condition, in which the SRD is installed anywhere in the allowable attachment area, which ranges from directly above the user to level with the FBH D-ring, as shown in Figure 10.

The overhead condition minimum required fall clearance (MRFC) is calculated using four metrics, measured from the walking-working surface: SRD Deceleration Distance, D-Ring Shift and Harness Stretch [1 ft (0.3m)], Safety Factor [1.5 ft (0.5m)], and Swing Fall. The diagram in Figure 11 is calculated using the performance data of the SRD and includes all four metrics listed previously to determine the MRFC.

### 5.5.2 FT-X with a Non-Overhead Anchorage Leading Edge Anchorage Application

[130 to 310 lbs. (59 to 141 kg) user]

The leading edge/below D-ring condition minimum required fall clearance (MRFC) is calculated using five metrics, measured from the walking-working surface: SRD Deceleration Distance, D-Ring Shift and Harness Stretch [1 ft (0.3m)], Safety Factor [1.5 ft (0.5m)], Dorsal D-ring Height [5 ft (1.5m)], and Swing Fall. Dorsal D-ring height is added to account for the below D-ring tie-off compared to the overhead condition.

Figure 10 - MRFC Overhead Anchorage

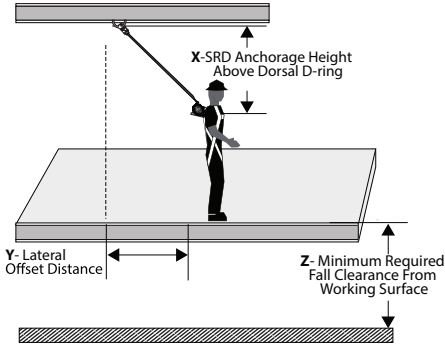

Figure 11 - MRFC Non-Overhead Anchorage

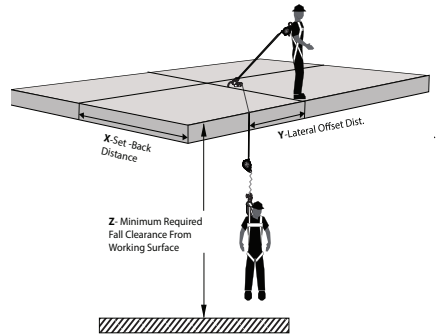
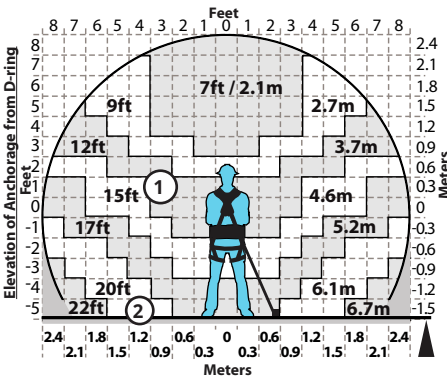

Figure 12 - FT-X Minimum Required Fall Clearance for 130 to 310 lbs. (59 to 141 kg) Users

#### Horizontal Distance to Anchorage from Dorsal D-Ring



Minimum Required Fall Clearance Indicated in figure above  
**MINIMUM REQUIRED FALL CLEARANCE FOR**

**130-310 lb (59-141kg) USER**

1 foot (0.3 m) increments along the X-Axis represents the <b>Horizontal Distance to Anchorage</b> the user is working away from the SRD	1 foot (0.3 m) increments up the Y-Axis represent the <b>Elevation of the Anchorage</b> from the user's Dorsal D-Ring
---	---

**Example 1:**  
 If the user is working 3 feet (0.9 m) away from the SRD, and the SRD is anchored between the user's Dorsal D-Ring or up to 2.0 ft (0.6 m) above the D-Ring. Minimum required fall clearance is 12 feet (3.7m) including swing fall.

**Example 2:**  
 If the user needs to work 4 feet (1.2 m) away from the SRD along the edge, and the SRD is anchored at foot level, the minimum required fall clearance is 20 feet (6.1m) including swing fall.

### 5.5.3 FT-X in Overhead, Non-Leading Edge Anchorage Application

[310 to 420 lbs. (141 to 11 kg) user]

The FT-X may be used may be used as a standard SRD in an overhead condition, in which the SRD is installed anywhere in the allowable attachment area, which ranges from directly above the user to level with the FBH D-ring, as shown in Figure 13.

The overhead condition minimum required fall clearance (MRFC) is calculated using four metrics, measured from the walking-working surface: SRD Deceleration Distance, D-Ring Shift and Harness Stretch [1 ft (0.3m)], Safety Factor [1.5 ft (0.5m)], and Swing Fall. The diagram in Figure 15 is calculated using the performance data of the SRD and includes all four metrics listed previously to determine the MRFC.

### 5.5.4 FT-X with a Non-Overhead Anchorage Leading Edge Anchorage Application

[310 to 420 lbs. (141 to 191 kg) user]

The leading edge/below D-ring condition minimum required fall clearance (MRFC) is calculated using five metrics, measured from the walking-working surface: SRD Deceleration Distance, D-Ring Shift and Harness Stretch [1 ft (0.3m)], Safety Factor [1.5 ft (0.5m)], Dorsal D-ring Height [5 ft (1.5m)], and Swing Fall. Dorsal D-ring height is added to account for the below D-ring tie-off compared to the overhead condition.

Figure 13 - MRFC Overhead Anchorage

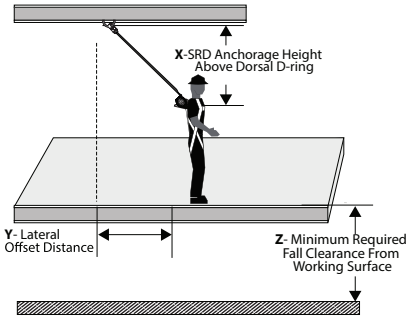

Figure 14 - MRFC Non-Overhead Anchorage

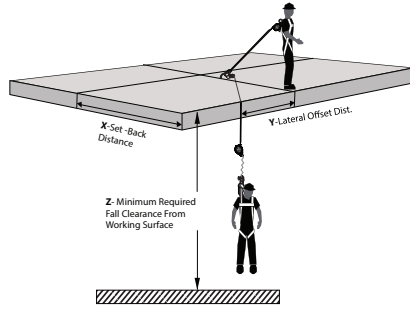
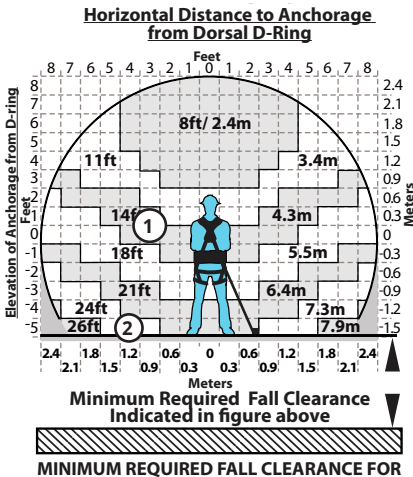

Figure 15 - FT-X Minimum Required Fall Clearance for 310 to 420 lbs. (141 to 191 kg) Users



310-420 lb (141-191 kg) USER

1 foot (0.3 m) increments along the X-Axis represents the **Horizontal Distance to Anchorage** the user is working away from the SRD

1 foot (0.3 m) increments up the Y-Axis represent the **Elevation of the Anchorage** from the user's Dorsal D-Ring

**Example 1:**

If the user is working 3 feet (0.9 m) away from the SRD, and the SRD is anchored between the user's Dorsal D-Ring or up to 1.0 ft (0.3 m) above the D-Ring. Minimum required fall clearance is 14 feet (4.3 m) including swing fall.

**Example 2:**

If the user needs to work 4 feet (1.2 m) away from the SRD along the edge, and the SRD is anchored at foot level, the minimum required fall clearance is 24 feet (7.3 m) including swing fall.

## 6.0 Maintenance, Service, and Storage

### 6.1 Maintenance:

Ensure the SRL is kept free of excess paint, grease, dirt or other contaminants as this may cause the lifeline or retracting mechanism to malfunction. Ensure no debris enters the housing. Clean the exterior of the unit as required with a detergent/water solution. Do not allow water or other corrosion causing elements to enter the housing. After cleaning, pull the lifeline all the way out, allow the unit to air dry, then retract the lifeline into the unit. Clean labels as required.

DO NOT use heat to dry.

DO NOT attempt to disassemble the SRL.

### 6.2 Service:

If service is required for any reason, such as inspection failure, impact loading, any type of malfunction, tag the unit as "UNUSABLE" and remove from service. This product includes a feature that enables the integral SRDs to be replaced individually if the SRD lifeline is worn or damaged during normal use. Any damage to the shock pack or deployed visual indicator cannot and shall not be serviced or repaired. Once removed from service, the SRD unit can be removed and replaced using the 5049 Spanner Tool. SRD unit replacement shall only be performed by a Competent Person or an Authorized FallTech Repair Center. Read and follow the Spanner Tool User Instruction Manual (448-00009). Failure to do so can cause the SRL to function improperly, which can result in serious injury or death. SRL must be inspected by a Competent Person before returning to service. To request a 5049 Spanner Tool, contact FallTech.

### 6.3 Storage:

Store the FT-X EdgeCore Arc Flash Tie-Back in a cool, dry, clean environment out of direct sunlight. Position the SRL so excess water can drain out. Avoid exposure to chemical or caustic vapors. Thoroughly inspect the SRL after any period of extended storage.

## 7.0 Inspection

### 7.1 Pre-Use User Inspection:

Perform an inspection before each use in accordance with the recommendations in Table 1 below.

<b>Inspection</b>	<b>Pass</b>	<b>Fail</b>
The lifeline should extract and retract completely and without faltering and should remain taut under tension without sagging.		
Extract the lifeline several inches and apply a firm pull to confirm the SRL locks. The locking should be certain and without skidding. Repeat this lockup at additional places along the lifeline length to confirm the SRL is operating correctly.		
Inspect entire length of the lifeline for abrasion, broken or unraveled yarns, burns, cuts or knots. Inspect for damage from dirt, paint, grease, or oil. Inspect for discoloration or other damage caused by chemical exposure or excessive heat. Inspect for cracking or other damage from extreme exposure to ultraviolet light. If any of these conditions exist, remove the SRL-P from service immediately.		
Examine the SRL-FBH Connector for cracks, breaks, or warping. Ensure the locking bar locks in the locked position.		
Check the Energy Absorber for rips, tears, or other damage.		
Check the Connector Assembly for cracks, deformations, or other damage.		
Examine the overall SRL unit for any indications of deterioration or damage.		
All labels must be intact and legible.		

**If an inspection reveals defects or damage to the equipment, remove the equipment from service.**

## 7.2 Inspection Frequency:

Inspection by a competent person at regular intervals is required. The competent person will use the information in Table 2, SRL Inspection Recommendations, to determine the inspection frequency. Use Table 2 to determine the inspection frequency. Inspection by a factory authorized inspection entity at regular intervals is also recommended.

<b>Table 2 - ANSI Z359.14-2021 SRL Inspection Recommendations</b>			
<b>Type of Use</b>	<b>Application Examples</b>	<b>Conditions of Use</b>	<b>Inspection Frequency Competent Person</b>
<b>Infrequent to Light Use</b>	Rescue and Confined Space, Factory Maintenance	Good Storage Conditions, Indoor or Infrequent Outdoor use, Room Temperature, Clean Environments	Annually
<b>Moderate to Heavy Use</b>	Transportation, Residential Construction, Utilities, Warehouse	Fair Storage Conditions, Indoor and extended outdoor use, All temperatures, Clean or dusty environments	Semi-annually to Annually
<b>Severe to Continuous Use</b>	Commercial Construction, Oil and Gas, Mining	Harsh Storage Conditions, Prolonged or Continuous outdoor Use, all temperatures, Dirty environments	Quarterly to Semi-annually

## 7.3 Inspection Checklist:

Use Table 1: Guidelines for Cable SRL Inspection to inspect the SRL.

## 7.4 Inspection Results:

If an inspection reveals defects in or damage to the equipment, inadequate maintenance, or activated fall indicators, remove the equipment from service.

## 7.5 Inspection Document:

Record inspection results on the Inspection Record provided below or on a similar document.





## 8.0 Labels

Product labels must be present and legible.

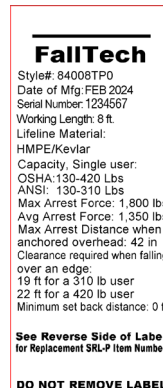
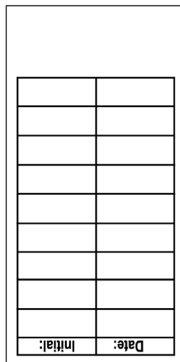
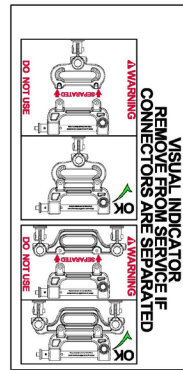
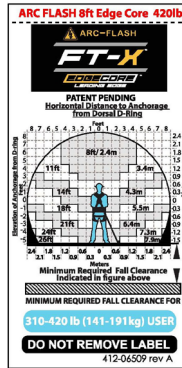
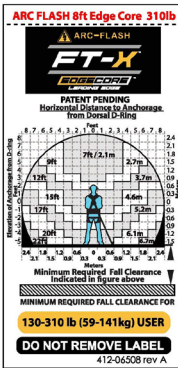
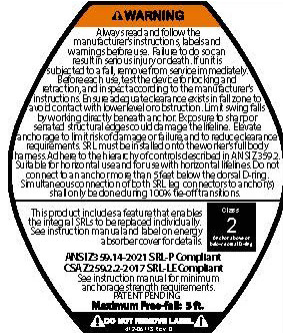

Replace SRL-P Only with Item Number  
84008RP0  
See User Instruction Manual  
488-00009 for Replacement Procedures  
Failure to do so may result in  
serious injury or death

## 9.0 Definitions

The following are general definitions of fall protection terms as defined by ANSI Z359.0-2012.

**Anchorage:** A secure connecting point or a terminating component of a fall protection system or rescue system capable of safely supporting the impact forces applied by a fall protection system or anchorage subsystem.

**Anchorage Connector:** A component or subsystem that functions as an interface between the anchorage and a fall protection, work positioning, rope access or rescue system for the purpose of coupling the system to the anchorage.

**Arrest Distance:** The total vertical distance required to arrest a fall. The arrest distance includes the deceleration distance and activation distance.

**Authorized Person:** A person assigned by the employer to perform duties at a location where the person will be exposed to a fall hazard.

**Available Clearance:** The distance from a reference point, such as the working platform, to the nearest obstruction that an authorized person might contact during a fall which, if struck, could cause injury.

**Capacity:** The maximum weight that a component, system or subsystem is designed to hold.

**Certification:** The act of attesting in writing that the criteria established by these standards or some other designated standard have been met.

**Certified Anchorage:** An anchorage for fall arrest, positioning, restraint or rescue systems that a qualified person certifies to be capable of supporting the potential fall forces that could be encountered during a fall.

**Clearance:** The distance from a specified reference point, such as the working platform or anchorage of a fall arrest system, to the lower level that a worker might encounter during a fall.

**Clearance Requirement:** The distance below an authorized person that must remain clear of obstructions in order to ensure that the authorized person does not make contact with any objects that would cause injury in the event of a fall.

**Competent Person:** An individual designated by the employer to be responsible for the immediate supervision, implementation and monitoring of the employer's managed fall protection program who, through training and knowledge, is capable of identifying, evaluating and addressing existing and potential fall hazards, and who has the employer's authority to take prompt corrective action with regard to such hazards.

**Component:** An element or integral assembly of interconnected elements intended to perform one function in the system.

**Connecting Subsystem:** An assembly, including the necessary connectors, comprised of all components, subsystems, or both, between the anchorage or anchorage connector and the harness attachment point.

**Connector:** A component or element that is used to couple parts of the system together.

**Deceleration Distance:** The vertical distance between the user's fall arrest attachment at the onset of fall arrest forces during a fall, and after the fall arrest attachment comes to a complete stop.

**Energy (Shock) Absorber:** A component whose primary function is to dissipate energy and limit deceleration forces which the system imposes on the body during fall arrest.

**Fall Arrest:** The action or event of stopping a free fall or the instant where the downward free fall has been stopped.

**Fall Hazard:** Any location where a person is exposed to a potential free fall.

**Free Fall:** The act of falling before a fall protection system begins to apply forces to arrest the fall.

**Free Fall Distance:** The vertical distance traveled during a fall, measured from the onset of a fall from a walking working surface to the point at which the fall protection system begins to arrest the fall.

**Harness, Full Body:** A body support designed to contain the torso and distribute the fall arrest forces over at least the upper thighs, pelvis, chest and shoulders.

**Horizontal Lifeline:** A component of a horizontal lifeline subsystem, consisting of a flexible line with connectors or other coupling means at both ends for securing it horizontally between two anchorages or anchorage connectors.

**Horizontal Lifeline Subsystem:** An assembly, including the necessary connectors, comprised of a horizontal lifeline component and, optionally, of: a) An energy absorbing component or, b) A lifeline tensioner component, or both. This subsystem is normally attached at each end to an anchorage or anchorage connector. The end anchorages have the same elevation.

**Lanyard:** A component consisting of a flexible rope, wire rope or strap, which typically has a connector at each end for connecting to the body support and to a fall arrester, energy absorber, anchorage connector or anchorage.

**Lanyard Connecting Subsystem:** An assembly, including the necessary connectors, comprised of a lanyard only, or a lanyard and energy absorber.

**Personal Fall Arrest System (PFAS):** An assembly of components and subsystems used to arrest a person in a free fall.

**Positioning:** The act of supporting the body with a positioning system for the purpose of working with hands free.

**Positioning Lanyard:** A lanyard used to transfer forces from a body support to an anchorage or anchorage connector in a positioning system.

**Qualified Person:** A person with a recognized degree or professional certificate and with extensive knowledge, training and experience in the fall protection and rescue field who is capable of designing, analyzing, evaluating and specifying fall protection and rescue systems.



**Self-Retracting Device (SRD):** A device that contains a drum wound line that automatically locks at the onset of a fall to arrest the user, but that pays out from and automatically retracts onto the drum during normal movement of the person to whom the line is attached.

**Snaphook:** A connector comprised of a hook-shaped body with a normally closed gate or similar arrangement that may be opened to permit the hook to receive an object and, when released, automatically closes to retain the object.

**Swing Fall:** A pendulum-like motion that occurs during and/or after a vertical fall. A swing fall results when an authorized person begins a fall from a position that is located horizontally away from a fixed anchorage.

APPENDIX A

**Table 1A: Specifications for FT-X™ EdgeCore™ Arc Flash Tie-Back Class 2 Leading Edge SRL-Ps**

Model #	Lifeline Material	Working Length and Weight	Materials and Specifications	Capacity and Standards	Images
84008SP8 84008SP8S	Kevlar	8 ft. (2.4 m) 5.8 lbs. (2.6 kg)	Housing: Nylon  Anchorage Carabiner: 5,000 lbs (22.2 kN)with 3,600 lbs (16 kN) Gate Strength	Single User Capacity for ANSI Compliance: 130 to 310 lbs. (59 to 141 kg)  Single User Capacity for OSHA Compliance: 130 to 420 lbs. (59 to 191 kg)	
84008TP8 84008TP8S		8 ft. (2.4 m) 7.3 lbs. (3.3 kg)	SRL-FBH Connector: Forged Aluminum 3,600 lbs (16 kN) Minimum	ANSI Z359.14-2021 Class 2 SRL-P  OSHA 1926.502 OSHA 1910.140	

**Table 1B: FT-X™ EdgeCore™ Arc Flash Tie-Back Class 2 SRL-P ANSI/OSHA Performance Attributes**

Part #s and Conditions		Typical Performance for 130 to 310 lbs. (59-141 kg) User			Typical Performance for 130 to 420 lbs. (59-191 kg) User			ANSI Performance Requirements 130 to 310 lbs. (59-141 kg) User		
Part #	Anchorage Condition	Arrest Distance	Average Arrest Force	Maximum Arrest Force	Arrest Distance	Average Arrest Force	Maximum Arrest Force	Maximum Arrest Distance	Average Arrest Force *Conditioned	Maximum Arrest Force
All Part Numbers in Table 1A	Overhead Non-Leading Edge	35" (0.9 m)	906 lbf. (4.0 kN)	1,259 lbf. (5.6 kN)	48" (1.2 m)	746 lbf. (3.3 kN)	1,124 lbf. (5.0 kN)	42" (1.1 m)	1,575 lbf. (7.0 kN)	1,800 lbs. (8 kN)
	Leading Edge Condition, 5' Below D-Ring	122" (3.1 m)	830 lbf. (3.7 kN)	1,618 lbf. (7.2 kN)	155" (3.9 m)	780 lbf. (3.5 kN)	1,246 lbf. (5.5 kN)	N/A	N/A	

**Table 1C: FT-X™ EdgeCore™ Arc Flash Tie-Back Replacement SRD Part Numbers**

Part #	Leg-end Connector
5049	N/A; Spanner Tool
84008RP8	Steel 5k Carabiner
84108RP8S	Steel 5k Snap Hook