



Distributed By

WESTECH RIGGING SUPPLY

Visit Us Online at: www.WestechRigging.com

Call Us Toll Free at: 800-442-7475

Call Us or Visit Our Stores: Monday - Friday, 8:00am - 5:30pm Pacific

4140 West 11th Avenue
Eugene, Oregon 97402

2439 McGilchrist St SE
Salem, Oregon 97302

pewag

**STRONG
IS NOT
ENOUGH**

www.pewag.com

product catalog

Industrial Products



winner pro™
Grade 120

winner™
Grade 100

and more ...

History

At the core of chain innovation since 1479

pewag is one of the oldest chain manufacturers in the world and the company's history goes back over 535 years when the first production facility was established in the town of Brückl, Austria in 1479. With over 535 years of engineering and manufacturing know-how, pewag has continued its research and development to provide the highest-quality innovative chain products to the market.

The pewag brand is well-known for premium-quality chain products around the world and is well established as a global market leader.

Today, pewag is the technological innovator in the high quality chain business and offers a diverse line of round-link chains for overhead lifting, hoists, conveying, traction and tire protection chains.

Timetable of important events

- 1479** First documented references of a forging plant in Brückl
- 1787** Foundation of a chain forgery in Kapfenberg
- 1803** Foundation of a chain forgery in Graz
- 1836** Establishment of an iron casting plant in Brückl
- 1912** Production of the First Snow Chain worldwide
- 1923** Merger of plants in Graz and Kapfenberg – Creation of the name “pewag”
- 1947** Production of the first Tire Protection Chain
- 1975** Established pewag Inc. the North American Distribution Company
- 1991** pewag introduces Grade 100 Chain and components as the first manufacturer in the world
- 1992** pewag produces the largest tire protection chain in the world -recorde in the Guinness Book of World Records
- 1993** Establishment of a manufacturing facility in Czech Republic
- 2002** pewag introduces Grade 120 chains and components as the first manufacturer in the world - The World's strongest chain
- 2003** pewag manufactures the world's largest TPC for a 60/80-57 giant loader tire
- 2004** pewag wins the Pinnacle Award for the introduction of Grade 120 in the USA
- 2007** pewag launches it's new generation of 23mm TPC
- 2009** pewag Inc. opens it's new North American headquarters in Bolingbrook, Illinois
- 2013** Creation of pewag Mexico
- 2014** pewag opens first chain production plant outside of Europe in Pueblo, CO
- 2016** Creation of pewag Canada

Contact

pewag
North American
Corporate Offices
600 W. Crossroads Parkway
Bolingbrook, IL 60440
Phone 800-526-3924
Fax 630-759-0788

sales@pewagchain.com · www.pewagchain.com

pewag
Traction Headquarters
3825 Cincinnati Ave., Suite D
Rocklin, CA 95765
Phone 800-445-2895
Fax 916-408-0575



Lithography forging plant Brückl 1855



Anchor chain forgery 1878



Chain forgers 1956

Business areas

Working with pewag products

The pewag group has a substantial and diverse spectrum of products and services.

Our Products range from:

- **Traction Chains** for cars, trucks, special purpose vehicles
- **Tire Protection Chains** for mining vehicles
- **Industrial Lifting Chains.**

DISCLAIMER FOR PRINTED LITERATURE :

The information contained in this catalog is to be used only as a guide to assist with product selection. Pewag Inc. makes no representation or warranty as to the completeness or accuracy of the information contained herein. The products and specifications set forth in this catalog are subject to change without notice and Pewag Inc. disclaims any and all liability for such changes. The information contained herein is provided without warranties of any kind, either express or implied, and Pewag Inc. disclaims any and all liability for typographical, printing, or production errors or changes affecting the products and/or the specifications contained herein. It is the responsibility of the customer to thoroughly analyze all aspects of the customers' proposed application for the products. Due to the diversity of possible applications of Pewag Inc. products, the customer is solely responsible for making the final selection of the product(s) to be used and to assure that all performance, safety and warning requirements of the application are satisfied.

Grade 120

Features and benefits in Grade 120 quality	10
NI Lifting Chain Pewag Winner Pro	11
Pewag Winner Pro Identification	11
M Enlarged Master Link	12
VM Enlarged Master Link Assembly	12
C Connex Connecting Link	12
KHS Clevis Sling Hook	13
HS Eye Sling Hook	13
LH Safety Hook	13
P Grab Hook	14
PS Grab Hook With Safety Pin	14

KP Clevis Grab Hook	14
RLB Loadbinder	14
CBH Connex Bolt And Bushing Set	15
SFG Forged Safety Latch Set	15
VLH Trigger Set	15
PSG Safety Pin Set	15
User Manual G120	16

Grade 100

Features and benefits in Grade 100 quality	22
Demanding Conditions	23
Standard sling types	24
NI Round Steel Chain	26
A Master Link	26
M Enlarged Master Link	27
V Master Link Assembly	27
VM Enlarged Master Link Assembly	28
BW Secondary Links On Master	28
VXK1 Clevis Master Set	29
VXK2 Clevis Master Set	29
VXK4 Clevis Master Set	29
C Connex Connecting Link	30
CL Connex Connecting Link, Non-Removable	30
XK Clevis Shortening Hook	31
KHS Clevis Sling Hook	31

HS Eye Sling Hook	32
KP Clevis Grab Hook	32
P Eye Grab Hook	33
PS Eye Grab Hook With Safety Catch	33
KPS Clevis Grab Hook with Safety Catch	33
WLH Swivel Safety Hook	34
KLH Clevis Eye Safety Hook	35
LH Eye Safety Hook	35
KF Clevis Foundry Hook	36
F Eye Foundry Hook	36
BW Sheet Metal Plate Hook	36
CAR Round Sling Connecting Link	37
KO Clevis Reeving Link	37
RLB Loadbinder	37
KCH Clevis C-Hook	38
KSCH Clevis Shackle	38
Spare Parts G100	39

Grade 80

NI Alloy Chain	44
AR Clevis Sling Hook	44
AR Clevis Grab Hook	40
AR Clevis Grab Hook with Safety Pin	45
R Connecting Links	45
DS/ES Eye Sling Hook	45
DS/ES Swivel Hook · Carbon and Alloy	46
AS Swivel Locking Hook	46

AN Sliding Chocker Hook	46
BH Bucket Hook	47
BHC Bucket Hook	47
DS/ES Shank Hook	47
SP Shackles	48
DS/ES Latch Kits For Sling Hooks	48
Spare Parts for G80	49

Grade 63

Capacities	52
WOX Lifting Chain	52
CWI Connecting Link	52
HSWI Eye Sling Hook	53
VWI Master Link Assembly	53
AWI Master Link	53
BWI Secondary Link Dimensions	54
VLWI Adjustable	54
Latch Kit for HSWI Stainless Steel Eye Sling Hook	54

Lifting Points

PLAW ALPHA Profillift	58
PLGW GAMA Profillift	60
PLBW BETA Profillift	62
PLE ETA Profillift	56

Information

Maximum Work Load of Various Chain Sling Applications	4
Chain Dimensions, Weights	5
Chain Load Rating	5
Maintenance, Inspection, Measuring, Maximum Tolerance	6
Identification And Testing	7
Contact Information	Back Page

Other Chains

Stainless Steel Chain NOT FOR OVERHEAD	68
Alloy Steel Hoist Chains	68
All Square Casehardened Security Chain	69

Maximum Work Load [lbs] of Various Chain Sling Applications

**Design Factor
4:1**

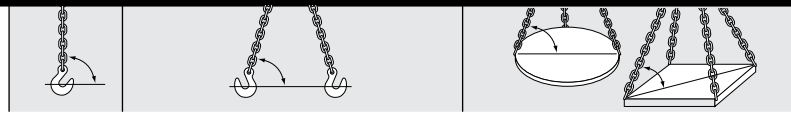

Grade 120 Alloy Winner Pro

Chain	Diameter	Angle: Load Factor:	90 degrees 1	60 degrees 1.7	45 degrees 1.4	30 degrees 1	60 degrees 2.6	45 degrees 2.1	30 degrees 1.4	Temperature Resistance
NI720	9/32"		5,200	9,000	7,400	5,200	13,500	11,000	7,800	Retains 100% of work load limit at -40 to 570°F. Not for temperatures over 570°F.
NI820	5/16"		6,600	11,400	9,300	6,600	17,100	14,000	9,900	
NI1020	3/8"		10,600	18,400	15,000	10,600	27,500	22,500	15,900	
NI1320	1/2"		17,900	31,000	25,300	17,900	46,500	38,000	26,900	
NI1620	5/8"		27,500	47,000	38,500	27,500	71,500	58,000	41,500	

Grade 100 Alloy Winner

Chain	Diameter	Angle: Load Factor:	90 degrees 1	60 degrees 1.7	45 degrees 1.4	30 degrees 1	60 degrees 2.6	45 degrees 2.1	30 degrees 1.4	Temperature Resistance
NI5.50	7/32"		2,700	4,700	3,800	2,700	7,000	5,700	4,000	Retains 100% of work load limit at -40 to 400°F. Not for temperatures over 400°F.
NI70	9/32"		4,300	7,400	6,100	4,300	11,200	9,100	6,400	
NI80	5/16"		5,700	9,900	8,100	5,700	14,800	12,100	8,500	
NI100	3/8"		8,800	15,200	12,400	8,800	22,900	18,700	13,200	
NI130	1/2"		15,000	26,000	21,200	15,000	39,000	31,800	22,500	
NI160	5/8"		22,600	39,100	32,000	22,600	58,700	47,900	33,900	
NI200	3/4"		35,300	61,100	49,900	35,300	91,700	74,900	53,000	
NI220	7/8"		42,700	74,000	60,400	42,700	110,900	90,600	64,000	
NI260	1"		59,700	103,400	84,400	59,700	155,100	126,600	89,550	
NI320	1-1/4"		90,400	156,600	127,800	90,400	234,900	191,800	135,600	

Grade 80 Alloy

Chain	Diameter	Angle: Load Factor:	90 degrees 1	60 degrees 1.7	45 degrees 1.4	30 degrees 1	60 degrees 2.6	45 degrees 2.1	30 degrees 1.4	Temperature Resistance
NI5.5	7/32"		2,100	3,600	3,000	2,100	5,500	4,400	3,200	Retains 100% of work load limit at -40 to 400°F, 90% at 400 to 570°F, and 75% at 570 to 750°F. Not for temperatures over 750°F.
NI7	9/32"		3,500	6,100	4,900	3,500	9,100	7,400	5,200	
NI8	5/16"		4,500	7,800	6,400	4,500	11,700	9,500	6,800	
NI10	3/8"		7,100	12,300	10,000	7,100	18,400	15,100	10,600	
NI13	1/2"		12,000	20,800	17,000	12,000	31,200	25,500	18,000	
NI16	5/8"		18,100	31,300	25,600	18,100	47,000	38,400	27,100	
NI20	3/4"		28,300	49,000	40,000	28,300	73,500	60,000	42,400	
NI22	7/8"		34,200	59,200	48,400	34,200	88,900	72,500	51,300	
NI26	1"		47,700	82,600	67,400	47,700	123,900	101,200	71,500	
NI32	1-1/4"		72,300	125,200	102,200	72,300	187,800	153,400	108,500	

Grade 63 Inox Stainless Steel

Chain	Diameter	Angle: Load Factor:	90 degrees 1	60 degrees 1.7	45 degrees 1.4	30 degrees 1	60 degrees 2.6	45 degrees 2.1	30 degrees 1.4	Temperature Resistance
WOX5	3/16"		1,400	2,400	2,000	1,400	3,600	2,900	2,100	Retains 100% of work load limit at -40 to 650°F, Not for temperatures over 650°F.
WOX7	9/32"		2,700	4,600	3,800	2,700	7,000	5,700	4,000	
WOX10	3/8"		5,500	9,300	7,700	5,500	14,300	11,500	8,200	
WOX13	1/2"		9,300	15,800	13,000	9,300	24,200	19,500	13,900	
WOX16	5/8"		13,900	23,600	19,500	13,900	36,100	29,200	20,800	

Reduction Factors

To be used for various slinging methods and conditions without shock loads.

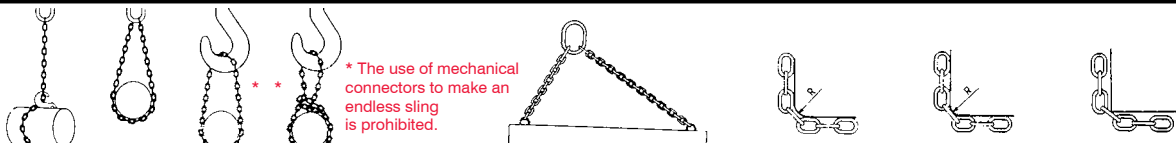

Load factor:

0.8

1.4

1.4

1.6

Reduction factor:

0.7

Asymmetrical distribution of load

1

R = more than 2 x chain dia

0.7

R = more than chain dia.

0.5

Sharp corners

Chain | Dimensions, Weights

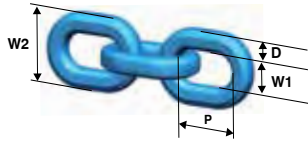

Grade 120 Alloy							
Code	Nominal Thickness D	Pitch p	Width Inside W1 min.	Width Outside W2 max	WLL lb Design Factor 4:1	Breaking Load [lb]	Weight [lb/ft]
NI720 (9/32")	0.276 (7mm)	0.866	0.393	1.024	5,200	20,800	0.874
NI820 (5/16")	0.315 (8mm)	0.984	0.433	1.142	6,600	26,400	1.040
NI1020 (3/8")	0.394 (10mm)	1.300	0.559	1.457	10,600	42,400	1.747
NI1320 (1/2")	0.512 (13mm)	1.614	0.732	1.949	17,900	71,600	3.091
NI 1620 (5/8")	0.630 (16mm)	2.008	0.748	1.969	27,500	110,000	4.820

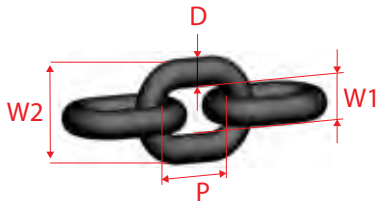

Diameter	Grade 100 Alloy	Grade 80 Alloy	Grade 63 Stainless Steel	Nominal Dia. D	Pitch P	Inside W1 min	Outside W2 max.	Weight [lb/ft]
3/16"	-	-	WOX 5	0.197	0.591	0.295	0.728	0.376
7/32"	NI5.50	NI5.5	-	0.217	0.680	0.319	0.787	0.470
9/32"	NI70	NI7	WOX7	0.276	0.826	0.375	0.992	0.738
5/16"	NI80	NI8	-	0.315	0.945	0.430	1.134	0.939
3/8"	NI100	NI10	WOX10	0.394	1.181	0.531	1.417	1.475
1/2"	NI130	NI13	WOX13	0.512	1.535	0.689	1.843	2.548
5/8"	NI160	NI16	WOX16	0.630	1.890	0.846	2.268	3.830
3/4"	NI200	NI20	-	0.787	2.440	1.008	2.776	5.780
7/8"	NI220	NI22	-	0.866	2.598	1.161	3.118	7.324
* 1"	NI260	NI26	-	1.024	3.071	1.378	3.704	10.214
1-1/4"	NI320	NI32	-	1.260	3.780	1.657	4.646	15.455

Chain | Load Rating

* Dimensions are for Grade 100, for Grade 80 the inner width W1 minimum is smaller, also W2 max is bigger.

Grade 120 Alloy				Grade 100 Alloy				Grade 80 Alloy				Grade 63 Stainless Steel			
Diameter	Working load [lb]	Manufacturing test load [lb]	Breaking load [lb]	Diameter	Working load [lb]	Manufacturing test load [lb]	Breaking load [lb]	Diameter	Working load [lb]	Manufacturing test load [lb]	Breaking load [lb]	Diameter	Working load [lb]	Manufacturing test load [lb]	Breaking load [lb]
	Design factor 4:1				Design factor 4:1				Design factor 4:1				Design factor 4:1		
												3/16"	1,400	2,800	5,600
				7/32"	2,700	5,400	10,800	7/32"	2,100	4,200	8,400				
9/32"	5,200	10,400	20,800	9/32"	4,300	8,600	17,200	9/32"	3,500	7,000	14,000	9/32"	2,700	5,400	10,800
5/16"	6,600	13,200	26,400	5/16"	5,700	11,400	22,800	5/16"	4,500	9,000	18,000				
3/8"	10,600	21,200	42,400	3/8"	8,800	17,600	35,200	3/8"	7,100	14,200	28,400	3/8"	5,500	11,000	22,000
1/2"	17,900	35,800	71,600	1/2"	15,000	30,000	60,000	1/2"	12,000	24,000	48,000	1/2"	9,300	18,600	37,200
5/8"	27,500	55,000	110,000	5/8"	22,600	45,200	90,400	5/8"	18,100	36,200	72,400	5/8"	13,900	27,800	55,600
				3/4"	35,300	70,600	141,200	3/4"	28,300	56,600	113,200				
				7/8"	42,700	85,400	170,800	7/8"	34,200	68,400	136,800				
				1"	59,700	119,400	238,800	1"	47,700	95,400	190,800				
				1 1/4"	90,400	180,800	361,600	1 1/4"	72,300	144,600	289,200				

Continuous Maintenance

Chain and fittings must be withdrawn from service if any damage or deformation is noticed.

Maintenance

Keep a record for all chain slings, and inspect them regularly in accordance with federal regulations and standards. (ASME B30.9)

Inspection Procedure

Each link and each attachment shall be examined individually, taking care to expose inner link surfaces of the chain and attachments.

Visual Inspection

Check for wear, nicks, cracks, breaks, gouges, stretch, bends, weld splatter, discoloration from excessive heat and throat opening of hooks.

Measuring

The medium link thickness must not be reduced by more than 10% of the nominal diameter on any part of the chain. The elongation of the chain should not exceed 5% at any point.

Maximum Tolerance

(For all chain and components).

Maximal approved dimensional change:

Designation	Dimensions (as show on product page)	Admissible deviation
chain	dn	-10%
	tn	+5% = (t)
links	dn	-10%
	tn	+10% = (t)
hooks *	e	+5%
	d2 and h	-10%
	g	+10%
C, CAR, CL	Halves loose	no changing admissible
	e	+5%
	c	-10%
BW,	e	+5%
	d1	+5%
	angle change	≤3%
LH, KLH, WLH(B)W	d2	-10%
	h	-10%
	opening of hook (dimension s)	2x s max.

* HS, F, P, KHS, KSCH, KCH
KF, KP, XK, KO, KR, DF

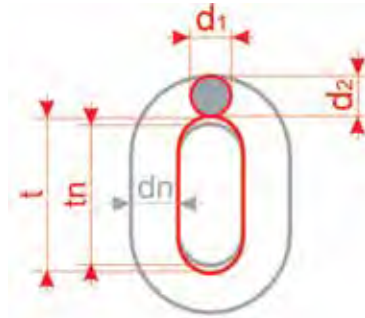

stretched due to elongation (overloading)

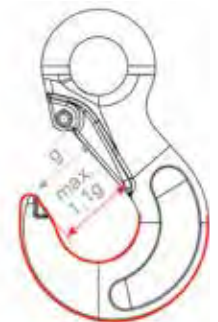

Hook bent open

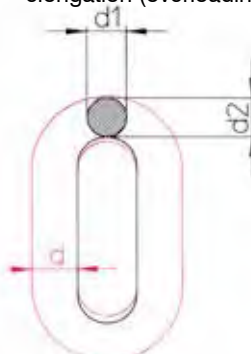

Pitch (p) increased due to wear



To be removed whenever a deformation is noticed



Lifting...

...is dangerous work

only competent persons are allowed to do.

Please keep in mind all the hazards and risks covered

in ASTM-A906,

ISO 3056,

EN 818-6

and other

relevant standards.

Inspection and testing should be carried out in accordance with all relevant regulations.

Identification And Testing

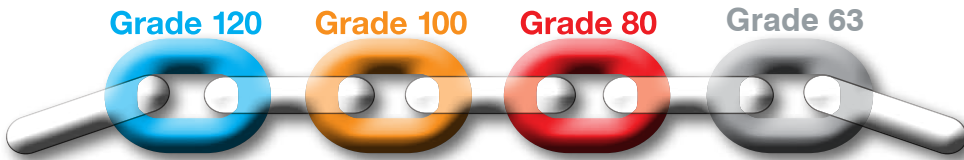

Pewag lifting chain and fittings are marked with a batch identification number and the manufacturer's identification marking: the number "120" or "12" to indicate Grade 120 Alloy, "100", "10" to indicate Grade 100 Alloy, "8" to indicate Grade 80 Alloy and "6" to indicate grade 63 Stainless.

All Alloy chains are 100% tested to 2 times the working load values and are furnished with a test certificate to this effect.

Every chain sling manufactured by pewag is supplied with a steel tag and test certificate as shown.



Messrs.		TEST CERTIFICATE					
Order No.							
Works Ref. No.							
Dimension of Chain	Nominal Diameter D	Pitch P	Outside Length L	Width W	Weight Lbs.		
	Norm. Designation						
Material		Welding Process		Heat Treatment			
Pieces	Length in Feet	Weight in Lbs.	Safe Working Load in Lbs.	Production Proof Test Load in Lbs.	Breaking Load in Lbs.	Minimum Elongation	
Total safe working load for multiple-leg chain							
Result of test		PEWAG INCORPORATED					
MEETS ALL STANDARDS		DATE:					

WARNING

Caution...

...do not exceed rated capacities



Grade 120 Winner Pro

Chain and Accessories



Features and benefits

The higher Working Load Limits (WLL) of the pewag winner-pro Grade 120 program (50% more compared to Grade 80 programs) allows significant weight reduction. Reducing the weight of the chain sling makes the assembly easier to use for the end-user. Additionally, the profile of the chain improves the bending resistance of the chain. This is significant when loading the chain over a corner.

Intelligent profile – because of the intelligent use of material, the major characteristics of the chain (i.e. fatigue resistance and bending resistance) were improved in a remarkable way, when you compare the cross section of the profile chain versus the round steel chain. In order to reach the best mechanical performance, the material use was optimized on effective areas (blue area) and reduced on less relevant areas (red area).



Optimized bending resistance: The section modulus which is important for preventing undesirable bending deformation is up to 16% higher with the profile chain compared to round steel chain with the same trade size section. Therefore the max. stress in the chain is reduced (no red areas).

50% higher load capacity compared to Grade 80, 20% higher load capacity compared to G100.



Obvious weight reduction and consequently easier handling.

One dimension smaller compared to Grade 80 and Grade 100 chain slings for many load ranges – thus providing excellent value.

Patent-registered material with optimized strength and toughness properties at both high and low temperatures.

Load	Sling Weight G80 (in lbs)	5 ft. DOS GRADE 120 (in lbs)	% Reduction
11,000	21.70	15.55	40%
18,000	36.67	26.59	38%
31,000	57.44	46.00	25%

Weight based performance - pewag Grade 120 represents the "Formula 1" of the technical chains

Load capacity [lbs]	Previous chain-ø	pewag winner pro chain-ø
9,300	3/8"	5/16"
15,600	1/2"	3/8"
24,600	5/8"	1/2"

Longer lasting due to higher wear resistance and less abrasion.

Strength to Weight of Chain

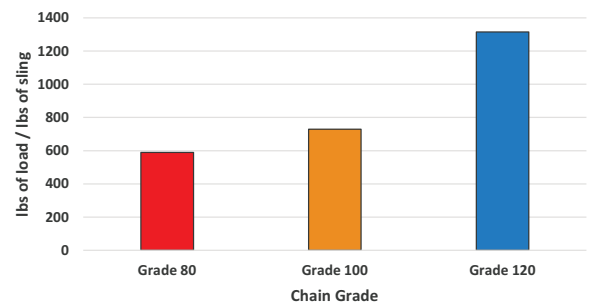

Innovative chain system that due to its ruggedness can be used for many applications not just for lifting.

Complete traceability – chains and components are stamped with an identification mark so that the whole production process can be tracked.

Easy visual identification due to profiled chain and Grade 120 marking on every link.

Corrosion protection by means of light blue powder coating of chains and components.

Quality approved European production by an ISO 9001 certified company.

Worldwide distribution network – easy delivery of spare parts - premium service.

Experience – pewag is the first supplier of an innovative Grade 120 chain system.

WLL of Slings

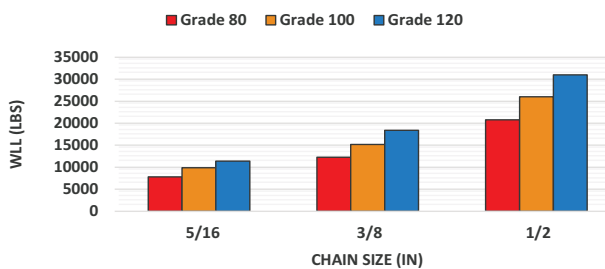

Sling Weight

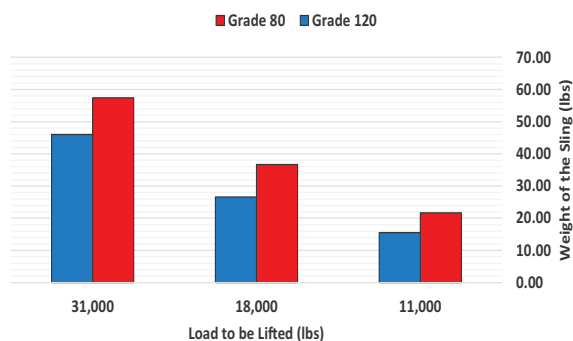

NI | Lifting Chain Pewag Winner Pro 300 Series

Highest quality grade 120 chain, rated for 570° F. Temperature. Powder coated blue (PC/B)
 Stamped pewag12, & Batch Code

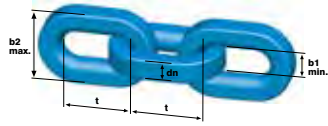

Code	Material thickness dn <small>[inch]</small>	Standard delivery length <small>[feet]</small>	Pitch t <small>[inch]</small>	Inside b1 min. <small>[inch]</small>	Outside b2 max. <small>[inch]</small>	WLL <small>[lb]</small>	Break. force <small>[lb]</small>	Weight <small>[lb/ft]</small>
NI720	9/32"	800	0.87	0.39	1.02	5,200	20,800	0.874
NI820	5/16"	500	0.98	0.43	1.14	6,600	26,550	1.040
NI1020	3/8"	400	1.30	0.55	1.46	10,600	42,400	1.747
NI1320	1/2"	200	1.61	0.75	1.97	17,900	71,600	3.091
NI1620	5/8"	100	2.00	0.75	1.97	27,500	110,000	4.820

NI | Lifting Chain Pewag Winner Pro 200 Series

High quality grade 120 chain, rated for 400° F. Temperature. Gray painted
 Stamped pewag12, 200, & Batch Code

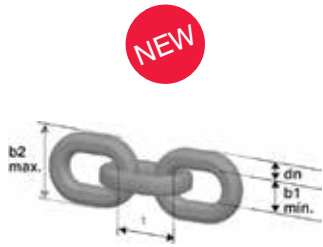

Code	Material thickness dn <small>[inch]</small>	Standard delivery length <small>[feet]</small>	Pitch t <small>[inch]</small>	Inside b1 min. <small>[inch]</small>	Outside b2 max. <small>[inch]</small>	WLL <small>[lb]</small>	Break. force <small>[lb]</small>	Weight <small>[lb/ft]</small>
NI720	9/32"	800	0.87	0.39	1.02	5,200	20,800	0.874
NI820	5/16"	500	0.98	0.43	1.14	6,600	26,550	1.040
NI1020	3/8"	400	1.30	0.55	1.46	10,600	42,400	1.747
NI1320	1/2"	200	1.61	0.75	1.97	17,900	71,600	3.091
NI1620	5/8"	100	2.00	0.75	1.97	27,500	110,000	4.820

M | Enlarged Master Link

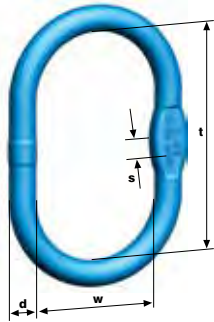

Code	For single leg sling	For 2 Leg Sling	WLL [lb]	d [inch]	t [inch]	w [inch]	s [inch]	Weight [lb/pc.]
M1320	9/32"	-	6,100	0.55	4.72	2.76	0.39	0.97
M1620	5/16"	-	8,400	0.67	5.51	3.15	0.51	1.48
M1820	3/8"	-	12,800	0.75	6.30	3.74	0.55	2.67
M2620	1/2"	-	30,000	1.06	7.48	4.33	0.79	5.84
M3020	5/8"	-	47,000	1.18	7.48	4.33	-	7.34
M3620	-	5/8"	71,500	1.50	10.8	5.91	1.14	16.5

VM | Enlarged Master Link Assembly

Enlarged master link assembly for 2, 3 and 4 leg chain slings. Match to chain size according to table.

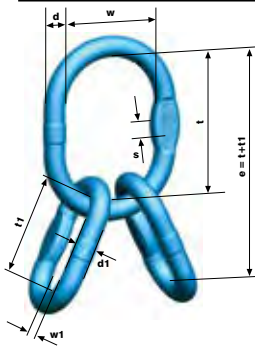

Code	For 2 leg sling	For 3 or 4 leg sling	WLL [lb]	e [inch]	d [inch]	t [inch]	w [inch]	d1 [inch]	t1 [inch]	w1 [inch]	Weight [lb/pc.]
VM720	9/32"	-	12,800	8.43	0.75	6.30	3.74	0.51	2.13	0.98	3.42
VM10720	3/8"	9/32"	22,000	10.24	1.06	7.48	4.33	0.67	2.76	1.34	7.43
VM131020	1/2"	3/8"	33,200	12.40	1.30	9.06	5.12	0.79	3.35	1.57	13.23
VM1320	-	1/2"	61,100	16.34	1.50	10.83	5.91	1.06	5.51	2.56	24.52
VM1620	-	5/8"	71,500	16.7	1.50	10.80	5.91	1.30	5.91	2.76	30.40

C | Connex Connecting Link

Connex connecting link for easy assembly of chains, master links, master link assemblies and components.

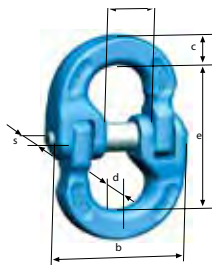

Code	Size [inch]	WLL [lb]	e [inch]	c [inch]	s [inch]	d [inch]	b [inch]	g [inch]	Weight [lb/pc.]
C720	9/32"	5,200	2.48	0.43	0.51	0.35	1.85	0.67	0.26
C820	5/16"	6,600	2.44	0.55	0.59	0.39	2.28	0.83	0.64
C1020	3/8"	10,600	2.76	0.63	0.79	0.51	2.60	0.87	0.73
C1320	1/2"	17,900	3.74	0.83	0.94	0.67	3.31	1.02	1.54
C1620	5/8"	27,500	5.04	1.06	0.98	1.61	0.82	1.89	4.98

KHS | Eye Sling Hook

For general lifting applications. All hooks with forged and galvanised safety latch.



Code	Size [inch]	WLL [lb]	e [inch]	h [inch]	a [inch]	d [inch]	g1 [inch]	b [inch]	Weight [lb/pc.]
KHS720	9/32"	5,200	4.13	1.02	0.75	0.37	1.42	3.98	1.85
KHS820	5/16"	6,600	4.13	1.02	0.75	0.42	1.42	3.98	1.85
KHS1020	3/8"	10,600	4.76	1.30	1.02	0.55	1.61	4.65	3.32
KHS1320	1/2"	17,900	5.83	1.69	1.18	0.69	1.93	5.79	6.27
KHS1620	5/8"	27,500	6.81	2.01	1.38	0.83	2.32	6.93	11.2

HS | Eye Sling Hook

For general lifting applications. All hooks with forged and galvanised safety latch.

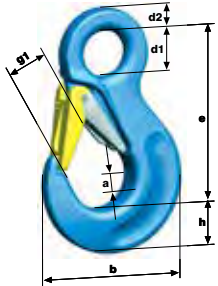

Code	Size [inch]	WLL [lb]	e [inch]	h [inch]	a [inch]	d1 [inch]	d2 [inch]	g1 [inch]	b [inch]	Weight [lb/pc.]
HS720/820	9/32" - 5/16"	6,600	4.17	1.06	0.75	0.98	0.43	1.02	3.46	1.10
HS1020	3/8"	10,600	5.16	1.30	1.02	1.34	0.63	1.22	4.25	2.43
HS1320	1/2"	17,900	6.46	1.69	1.30	1.69	0.75	1.54	5.20	4.85

LH | Safety Hook

Safety hook with larger opening than the eye sling hook. Closes and locks automatically under load. Ensures high level of safety.

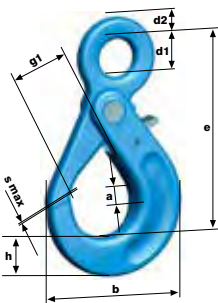

Code	Size [inch]	WLL [lb]	e [inch]	h [inch]	a [inch]	b [inch]	d1 [inch]	d2 [inch]	g1 [inch]	s max. [inch]	Weight [lb/pc.]
LH720/820	9/32" - 5/16"	6,600	4.96	0.98	0.94	3.50	0.98	0.55	1.34	0.04	1.98
LH1020	3/8"	10,600	6.22	1.22	1.10	4.41	1.22	0.67	1.77	0.08	3.53
LH1320	1/2"	17,900	8.07	1.61	1.34	5.71	1.57	0.87	2.13	0.08	7.28

P | Grab Hook

Special design of the chain contact area for optimal interaction between chain and hook.

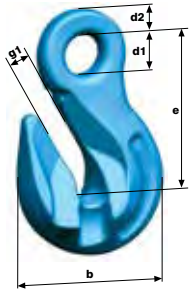

Code	Size [Inch]	WLL [lb]	e [Inch]	b [Inch]	d1 [Inch]	d2 [Inch]	g1 [Inch]	Weight [lb/pc.]
P720/820	9/32" - 5/16"	6,600	2.68	2.48	0.71	0.43	0.39	1.06
P1020	3/8"	10,600	3.46	3.19	0.87	0.55	0.51	2.27
P1320	1/2"	17,900	4.33	4.06	1.02	0.71	0.67	4.63

PS | Grab Hook With Safety Pin

Hook for shortening which prevents the accidental release of the chain. Special design of the chain contact area for optimal interaction between chain and hook.

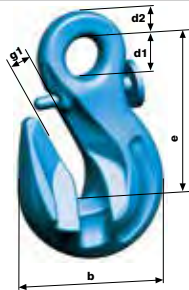

Code	Size [Inch]	WLL [Inch]	e [Inch]	b [Inch]	d1 [Inch]	d2 [Inch]	g1 [Inch]	Weight [lb/pc.]
PS720/820	9/32" - 5/16"	6,600	2.68	2.48	0.71	0.43	0.39	1.06
PS1020	3/8"	10,600	3.46	3.19	0.87	0.55	0.51	2.27
PS1320	1/2"	17,900	4.33	4.06	1.02	0.71	0.67	4.63

KP | Clevis Grab Hook

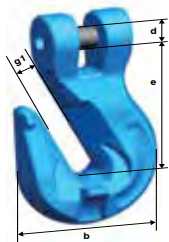

Code	Size [Inch]	WLL [Inch]	e [Inch]	b [Inch]	d [Inch]	g1 [Inch]	Weight [lb/pc.]
KP1620	5/8"	27,500	4.88	4.84	0.927	0.748	5.52

RLB | Loadbinder

For pewag winner pro connex system. Load binder with optimized lever length.

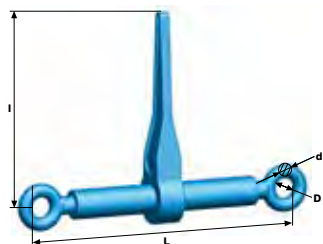

Code	Size [Inch]	Length closed L [Inch]	Length open L [Inch]	Tension range [Inch]	length of lever [Inch]	D [Inch]	d [Inch]	Weight [lb/pc.]
7G120RLB	9/32"	13.98	19.69	5.71	9.33	0.79	0.63	7.06
10G120RLB	3/8"	14.37	20.08	5.71	13.98	1.02	0.71	8.38
13G120RLB	1/2"	22.68	34.09	11.42	14.13	1.22	0.87	21.83

Image as shown is for dimensional purposes only. Load binders sold assembled (connector and grab hook included).

CBH | Connex Bolt And Bushing Set

Spare parts for CWP connex.

	Code	for connex type
	CBH7	C720
	CBH8	C820
	CBH10	C1020
	CBH13	C1320

SFG | Forged Safety Latch Set

Safety latch set for HSWP.

	Code	for hook type
	SFG7/8	HS720/820
	SFG10	HS1020
	SFG13	HS1320

VLH | Trigger Set

Trigger set for LHWP safety hooks.

	Code	for hook type
	VLH720	LH720/820
	VLH1020	LH1020
	VLH1320	LH1320

PSG | Safety Pin Set

Spare parts for PSG grab hooks with safety pin.

	Code	for hook type
	PSG70	PS720
	PSG10	PS1020
	PSG13	PS1320

User Manual

User manual for the assembly, use, storage and maintenance of pewag winner pro chain slings

General

The pewag winner pro chain system can be used in a wide range of applications. These applications must be checked for suitability by a competent authorized person, or by pewag itself in the event of doubt. One major application field of the pewag winner pro chain system is overhead lifting. The following information was prepared in acc. with ASME B30.9 assembling chain slings and rating of the capacity only refer to the uniform load method with angle ranges of 90°, 60°, 45°, 30° Degrees.

In addition, there is also an alternative method of rating the capacity. This method should only be used where weight and distribution of the load and the angles of the sling legs are known. In such cases please contact our technical department as the information given in this catalogue does not include details for chain sling rating using this alternative rating method! pewag winner pro lifting chains may only be assembled, tested and used by competent authorized people.

If used properly pewag winner pro lifting chains have a long service life and provide a high level of safety. Personal injury and damage to property can, only be prevented by proper use. Therefore, It is very important that you read and understand this user manual and act in a responsible and forward-thinking manner when using lifting equipment.

Limitations on use

The shape of the chain slings must not be modified – e.g. by bending, grinding, detaching individual parts, drilling, etc. The chain slings may also not be heated to above 400°F. Do not remove any safety components, such as latches, safety pins, safety catches, etc. Do not apply any surface coatings to pewag winner pro chain slings, e.g. do not subject them to hot dip galvanizing or electro-galvanizing. Dipping or removing the coating with chemicals is also dangerous and must approved by pewag.

If necessary, please contact our technical department who will be pleased to provide assistance.

Assembling chain slings

pewag winner pro chains and accessories may only be assembled by competent authorized people using pewag winner pro chains and accessories from the pewag winner pro chain system. When modifying or repairing pewag winner pro chain slings use only original parts supplied by pewag (e.g. bolts, safety pins, screws, etc.). pewag Winner Pro chains and components have

only limited compatibility with chains and components of other suppliers. Compatability should be checked in advance by competent authorized people. pewag will not be responsible for any damage arising as a result of combination with products from a different supplier.

It is imperative to adapt the WLL to the weakest link in the assembly. Appropriate markin/coloring must be used to prevent the user from misinterpreting the load capacity. pewag Winner pro chain slings must be labeled with specially developed identification tags. This tag may only be used if the WLL of the sling conforms to the values provided in the table on page 4. Deviating WLLs must be ighlighted on a separate tag (e.g. round shape)

Restrictions of use

Effects of temperature

pewag winner pro lifting accessories may not be used outside the temperature range stated. If this has nevertheless been the case, do not use the chain slings and remove them from service.

Effects of acids, caustics and chemicals

Do not subject pewag winner pro lifting accessories to acid or caustic solutions, or use them in acid or caustic-laden atmospheres. Certain production procedures release acids and/or fumes. Use of pewag winner pro lifting accessories in highly concentrated chemicals in combination with high temperatures is only permitted with explicit prior approval.

Working load limit

The working load limits in this catalogue and those on the chain sling have been determined on the basis that the loading of the chain sling is symmetrical and there are no particularly hazardous conditions. Hazardous conditions would be offshore applications, lifting of people, and lifting of dangerous loads. (e.g. liquid metals, corrosive materials, caustic materials, nuclear materials, etc.)If the chain sling is to be used for such purposes, the extent of the risk is to be assessed by an expert and the safe working load be adjusted accordingly.

Inspection and tests

Before using any lifting equipment for the first time, it should be ensured that:

- The chain sling corresponds exactly to the order.
- The inspection certificate or certificate of conformity has been supplied.
- Marking and load capacity stated on the chain sling correspond to the information given on the inspection certificate or certificate of conformity.
- All particularities of the chain sling have been entered into a register of lifting equipment, if required.
- Instructions for the proper use of chain sling has been supplied, read and understood by personnel.

Check the chain slings before each use for visible damage or signs of wear. In case of doubt or damage, do not use the chain slings, and have them inspected by a competent person. After extraordinary or unusual events that could cause impairment of the chain sling, the chain sling must be checked by an expert (e.g. after exposure to uncontrolled heat). As per ASME B30.9-1.9.3 standard we recommend subjecting the chain sling to a periodic inspection intervals which shall not exceed a year. Also, to a load test with 1.5 times the load capacity, followed by a visual inspection, or another type of crack test (fluxing).

Elimination criteria following visual inspection

- Broken part
- Missing or illegible marking of the chain sling, i.e. identification data and/or load capacity data
- Deformation of suspension or sling parts or the chain itself
- Elongation of the chain. The chain must be discarded if $t > 1.05 t_n$
- Wear is determined as the mean value of two measurements of diameters (d1 and d2) carried out at a right angle (see picture). The chain must be discarded if $d_m = \frac{d_1 + d_2}{2} \leq 0.9 d_n$

- For wear at the profile edges the criteria for withdrawal is $d < d_n$

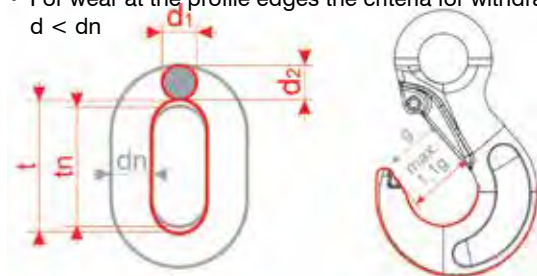

- Cuts, notches, grooves, surface cracks, excessive corrosion, discoloration due to heat, signs of subsequent welding, bent or twisted links or other flaws.
- Cracks: Chains with cross-cracks that are visible to the naked eye must be discarded.
- Missing or non-functional safety device (safety latches if fitted) as well as signs of widening or twisting of hooks, i.e. noticeable enlargement of the opening or other forms of deformation. The enlargement of the opening must not exceed 10% of the nominal value. A jumped out safety catch shows an overload of the hook.

Maximum approved dimensional change:

Designation	Dimensions	Admissible deviation
chain	dn	-10%
	tn	+5%
	wear at edges	d = dn
links	d	-10%
	t	+10%
hooks	e	+5%
	d2 and h	-10%
	g	+10%
connecting links	halves must be moveable	must be given
	e	+5%
	c	-10%
	d	-10%

Maintenance and repair

pewag lifting accessories and chain slings should only be repaired by qualified personnel using genuine pewag parts.

Documentation

Records of inspections, and in particular their findings, as well as details of repairs carried out must be kept on file during the entire service life of the chain sling.

Storage

pewag chain sling should be stored in cleaned and dried condition and protected from corrosion, e.g. lightly lubricated.

Correct use of pewag winner pro chain sling

Angle of inclination – sling points

Select slinging points and chain sling type in such a way that the angles of inclination of all chain strands (legs) lie within the data given on the CE marked plate. All angles of inclination should preferably be the same. Never use chain slings angles of less than 30°.

Edge load – protection of load and chain

The maximum load capacity of pewag chain slings was defined under the assumption that the individual chain legs are pulled straight under load, i.e. that they do not run over edges. In the case of edge loading, load protection (packing) should be used to avoid damage. For correct and incorrect use see illustrations.

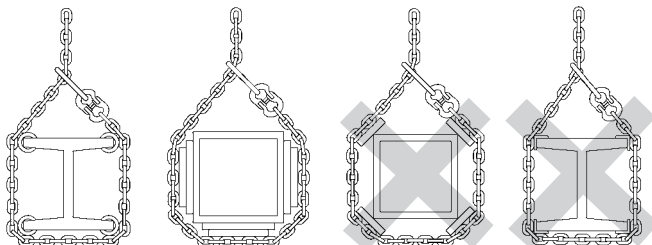

If chains are guided over edges without proper protection, their load capacity is reduced. For the corresponding load factors please refer to the table on page 4. If chains are looped around a beam or other round shaped loads, the diameter should be minimum 2 times the chain pitch. For smaller diameters the WLL of the chains must be reduced by 50%.

Impact

The maximum load capacity of pewag chain slings are defined under the assumption that the load on the individual chain strands (legs) is applied without any impact or shock loading. In cases of possible impact/shock, the load factors on page 23 must be taken into consideration.

Impact/shock is defined as follows:

- Slight impact: created, for example, when accelerating the lifting or lowering movement.
- Medium impact: created, for example, when the chain slips when adjusting to the shape of the load.
- High impact created, for example, when the load falls into the

User Manual (continues)

unloaded chain.

Vibrations/ Dynamic Forces

pewag winner pro chains and accessories are rated according to regulations for 20,000 load cycles. At high dynamic forces there may nevertheless be a risk of damage to the chain and accessories. According to the employer's liability insurance association Metall Nord Süd this risk may be prevented if the stress at load capacity limit is reduced by using a larger chain dimension.

Symmetrical loading

The load capacities of pewag chain slings are defined with the assumption that the load of the individual chain strands (legs) is symmetrically distributed. Lifting of the load then leads to identical angles of inclination, and the individual strands (legs) are symmetrical to each other.

The load can still be considered symmetrical when the following conditions are met:

- The load is smaller than 80 % of the stated load capacity (WLL)
- The chain sling leg angles to the vertical are all not less than 15°
- The angles to the vertical of all chain legs are identical or deviate max. 15° from each other
- In the case of three and four strand sling chains, the corresponding plan angles are all within 15° of each other.

Example of asymmetry

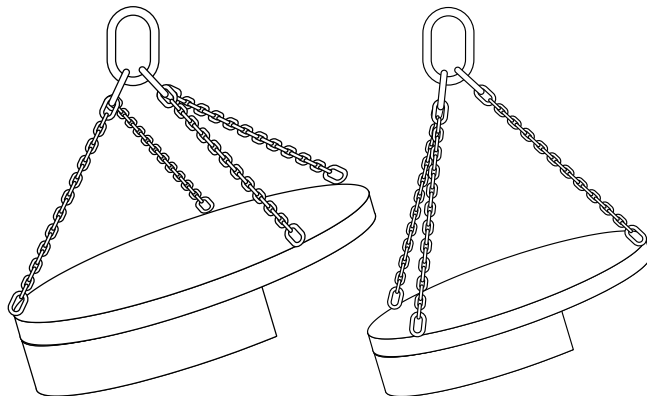

The majority of the load is carried by 1 strand (leg)

The majority of the load is carried by 2 strand (legs)

If all of the listed parameters are not met, the load is considered to be asymmetric and an expert must be called in to assess the lifting process. In case of doubt, only one chain strand (leg) should be considered as load-bearing. For the corresponding load capacity please refer to the load capacity table.

Use of pewag chain slings for other than the intended purposes

Use chain slings only for the intended purpose. In cases where not all individual strands (legs) are used simultaneously or where several chain slings are used at the same time, please refer to the load capacity table to find out the load capacity. In case of doubt or as an alternative, change the load capacity according to the following table.

Type of chain sling	Number of individual strands used	Use factor in relation to the load capacity given on the tag
two (2-leg)	1	1/2
three- and four- (3/4-leg)	2	2/3
three- and four (3/4-leg)	1	1/3
2x single (single leg)	2	1.4
2x (2 leg)	3 or 4	1.5

Hang any individual chain legs that you do not use, back into the master link to prevent hazards caused by freely swinging chains or unintended hooking.

Before using several chain slings at the same time, make sure that the crane hook is big enough for all the master rings. Make sure that the master rings cannot fall out of the hook during lifting. No angles of inclination of less than 30° allowed. Use only chain slings of the same nominal thickness and grade at the same time.

Detailed user manuals are available for download at www.pewag.com.





Grade 100 Winner

Chain and Accessories



User friendliness and safety are based on clearly defined and measurable characteristics, which are incorporated in the product development and production process of our products.

WLL of Slings

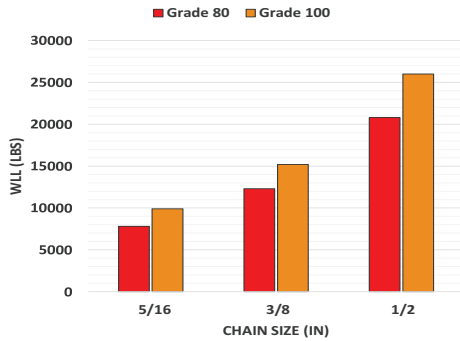

Load capacity	Previous Grade 80 chain Ø	pewag Grade 100 chain Ø
3.550	3/8"	5/16"
5.600	1/2"	3/8"
9.500	5/8"	1/2"

Strength to Weight of Chain

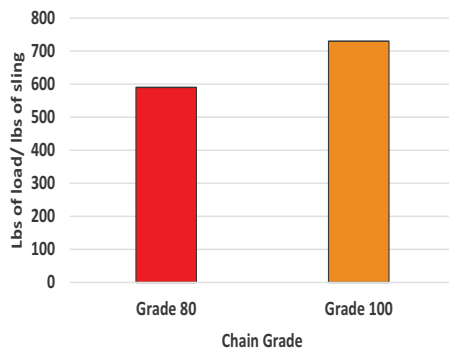

Load capacity	Previous chain weight	Grade 100 chain weight	% Weight reduction
7828 lbs	35.7 lbs	24.2 lbs	32%
12348 lbs	60.9 lbs	38.8 lbs	36%
20948 lbs	93.0 lbs	65.3 lbs	30%

Features And Benefits Of Chains In Grade 100 Quality

Attractive price/performance ratio thanks to the small price differential compared to Grade 80.

One dimension smaller than Grade 80 slings, for many load ranges – thus providing excellent value.

Extended service life due to higher wear resistance.

Identification made easy – each link is marked "W".

Traceability of all production data by use of codes on chains and components.

Simple visual identification of pewag Grade 100 components thanks to high visibility orange color powder coating.

Broad range of components in special Grade 100 quality.

Fastest and simplest assembly of slings thanks to VXK set with patented shortening element.

Avoiding danger through improperly shortened chains – an additional safety feature of our shortening hooks.

Easier daily/annual inspection – easier and faster in comparison to Grade 80, because fewer components are in use.

Compatible with our Grade 80 range – used slings easy to repair. Note: Grade 100 components can be used to repair Grade 80 slings but not at an increased working load.

First company to offer grab hooks with 100% load capacity – shortening of the sling chain does not require a reduction in load caused by shear effect of the hook.

Experience – in 1989 pewag where the first company to manufacture Grade 100 chain slings in the USA.

Quality-approved European production by an ISO 9001 certified company.

Worldwide distribution network – smooth supply of spare and replacement parts.

Components meet the requirements of ASTM / ASME

pewag Grade 100 – The Environmentally Friendly Chain

The ISO 14001 certification is also fully implemented with our Grade 100 lifting chains.

Reduced energy consumption during production

Less material used – protection of raw material reserve

Low weight – less to transport

Less material to be recycled

Demanding conditions

Edge load – protection of load and chain

The maximum load capacity of pewag chain slings was defined under the assumption that the individual chain legs are pulled straight under load, i.e. that they do not run over edges. In the case of edge loading, load protection (packing) should be used to avoid damage. For correct and incorrect use see below illustrations.

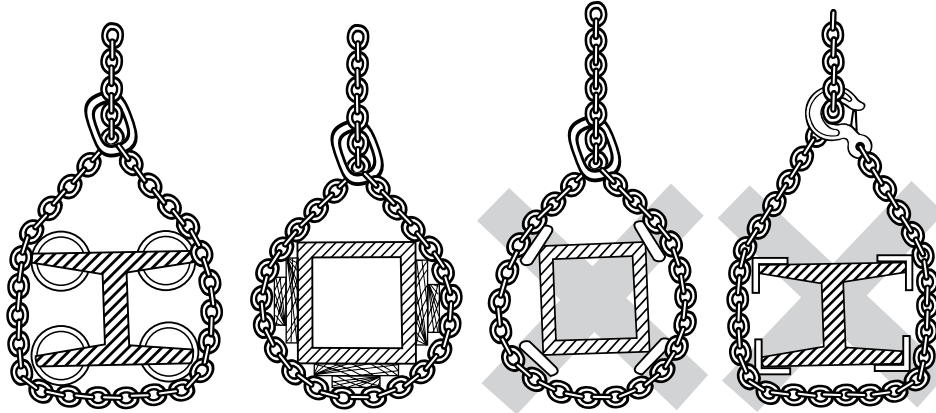

If chains are guided over edges without proper protection, their load capacity is reduced.

Asymmetric load distribution	The WLL has to be reduced by at least 1 leg. In case of doubt only consider 1 leg as load-bearing.		
Edge load *	R > 2d 	R > d 	R < d
Load factor	1	0.7	0.5
Shock	slight shocks	medium shocks	strong shocks
Load factor	1	0.7	not permissible

* d = thickness of the material

Temperature	-40°F – 400°F	above 400°F – 572°F	above 572°F – 800°F
Load factor pewag Grade 100	1	not permissible	not permissible

pewag Grade 100 Standard Sling Types

The chain slings shown here are standard sling types. They can – to some degree – also be produced and supplied in assembly systems other than the ones listed below. If you assemble them yourself, use only original pewag Grade 100 components! For any sling types not shown below, please submit a small sketch indicating the required type. The usual tolerance of length “L” is +2 chain pitches.



SOS



SOSL



SOG*



SOO

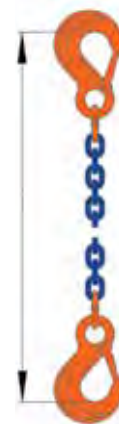

SSS



SOSLXK



DOS



DOSL



DOG*

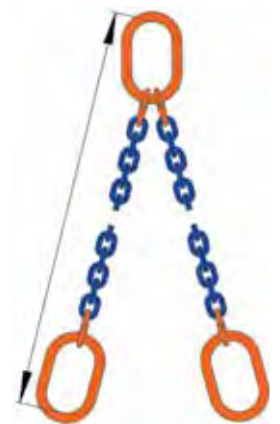

DOO



DOSXK

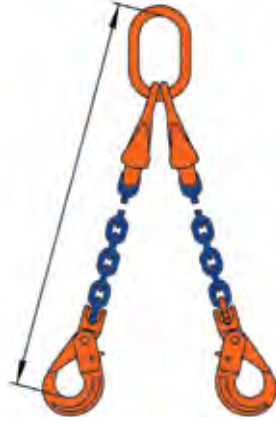

DOSLXK



DOSA



TOS



TOSL



TOG*



TOO



QOSXK



QOSLXK



QOS



QOO



SB



DB

* Must specify
with or without pin

NI | Round Steel Chain

Round steel chains for use in lifting. Maximum working temperature: 400°F. Standard surface: blasted, clear painted.

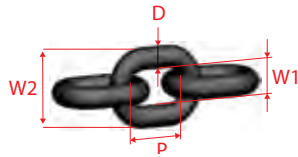

Code	Size	Nominal diameter d	Standard delivery length [feet]	Pitch t	Inside width b1 min.	Outside width b2 max.	WLL [lb]	Breaking force [lb]	Weight [lb/ft]
NI5.50	7/32"	0.217	400	0.67	0.31	0.83	2,700	10,800	0.470
NI70	9/32"	0.276	800	0.83	0.39	0.98	4,300	17,200	0.738
NI80	5/16"	0.315	500	0.94	0.43	1.14	5,700	22,800	0.939
NI100	3/8"	0.394	400	1.18	0.55	1.42	8,800	35,200	1.475
NI130	1/2"	0.512	200	1.54	0.71	1.85	15,000	60,000	2.548
NI160	5/8"	0.630	150	1.89	0.87	2.28	22,600	90,400	3.830
NI200	3/4"	0.787	100	2.36	1.02	2.80	35,300	141,200	5.780
NI220	7/8"	0.866	100	2.60	1.18	3.11	42,700	170,800	7.324
NI260	1"	1.024	100	3.07	1.38	3.70	59,700	238,800	10.214
NI320	1-1/4"	1.260	50	3.78	1.69	4.53	90,400	361,600	15.455

A | Master Link

Master link for 1 or 2 leg chain sling.



Code	WLL 90°-45° [lb]	d [Inch]	t [Inch]	w [Inch]	s [Inch]	Weight [lb/pc.]	Master link for chain	
							1-leg	2-leg
A100	3,800	0.39	3.15	1.97	0.39	0.31	7/32"	-
A130	5,800	0.51	4.33	2.36	0.39	0.75	9/32"	7/32"
A160	7,500	0.63	4.33	2.36	0.55	1.17	5/16"	9/32"
A180	10,000	0.75	5.31	2.95	0.55	2.03	3/8"	5/16"
A220	16,700	0.91	6.30	3.54	0.67	3.53	1/2"	3/8"
A260	26,000	1.06	7.09	3.94	0.79	5.42	5/8"	1/2"
A320	39,100	1.30	7.87	4.33	1.02	9.13	3/4"	5/8"
A360	61,100	1.42	10.24	5.51	-	13.72	7/8"	3/4"
A450	83,100	1.77	13.39	7.09	-	28.27	1"	7/8"
A500	111,000	1.97	13.78	7.48	-	36.49	1-1/4"	1"
A560	156,600	2.36	15.75	7.87	-	59.56	-	1-1/4"
A720	234,900	2.76	18.11	9.84	-	99.23	-	-

M | Enlarged Master Link

Similar to master link A, but due to larger inside dimensions suitable for next sized crane hook or special hook.



Code	WLL 90°-45° [lb]	d [Inch]	t [Inch]	w [Inch]	s [Inch]	Weight [lb/pc.]	Master link for chain	
							1-leg	2-leg
M100	3,800	0.43	3.54	2.56	0.39	0.49	7/32"	
M130	6,100	0.55	4.72	2.76	0.39	0.97	9/32"	7/32"
M160	8,400	0.63	5.51	3.15	0.51	1.48	5/16"	9/32"
M180	12,800	0.75	6.30	3.74	0.55	2.40	3/8"	5/16"
M220	18,500	0.91	6.70	3.99	0.67	3.73	1/2"	3/8"
M260	30,000	1.06	7.48	4.33	0.79	5.84	5/8"	1/2"
M320	45,000	1.30	9.06	5.12	1.02	10.54	3/4"	5/8"
M360	61,100	1.50	10.83	5.91	1.14	16.49	7/8"	3/4"

V | Master Link Assembly

For assembling 3- and 4-leg chains with connex links, and for rope slings.

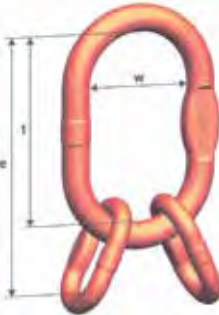

Code	Consisting of	WLL 90°-60° [lb]	e [Inch]	t [Inch]	w [Inch]	Weight [lb/pc.]	For Chain
V5.50	A180+2BW13*	8,100	7.44	5.31	2.95	2.78	7/32"
V70-80	A220+2BW16*	14,800	9.06	6.30	3.54	5.12	9/32" / 5/16"
V100	A260+2BW20*	22,900	10.43	7.09	3.94	8.11	3/8"
V130	A320+2BW22*	39,000	12.40	7.87	4.33	14.24	1/2"
V160	A360+2BW26*	58,700	15.75	10.24	5.51	22.18	5/8"
V200	A500+2BW32*	91,700	19.69	13.78	7.48	50.43	3/4"
V220	A500+2BW36*	110,900	20.47	13.78	7.48	54.66	7/8"
V260	A560+2BW45*	126,600	22.44	15.75	7.87	91.09	1"
V320	A720+2BW50*	234,900	25.98	18.11	9.84	146.85	1 1/4"

*BW dimensions on bottom of page 26

VM | Enlarged Master Link Assembly

For assembling 3- and 4-leg chain slings. Similar to V 4-leg set, but also suitable for larger crane hooks and special hooks.

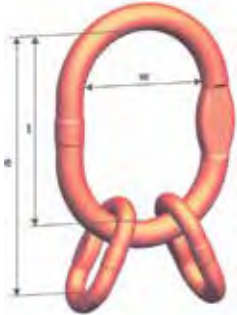

Code	WLL 90°-60° [lb] 4:1 for chain Slings	WLL 90°-60° [lb] 4:1 for Other than chain Slings	Consisting of	For Chain	e [Inch]	t [Inch]	w [Inch]	Weight [lb/pc.]
VM 5.50	7,000	12,800	M180 + 2 BW13	7/32"	8.43	6.30	3.74	3.15
VM70-80	11,200	18,500	M220 + 2 BW16	9/32"	9.06	6.30	4.33	5.31
VM100	22,900	30,000	M260 + 2 BW20	3/8"	10.83	7.48	4.33	8.84
VM130	39,000	45,000	M320 + 2 BW22	1/2"	13.58	9.06	5.12	15.21
VM160	58,700	61,100	M360 + 2 BW26	5/8"	16.34	10.83	5.91	24.52

BW | Secondary Links On Master Link Assembly

For dimensional purpose only -Not sold separately



Code	d [Inch]	t [Inch]	w [Inch]	s [Inch]	Weight [lb/pc.]
BW13	0.51	2.13	0.98	0.39	0.37
BW16	0.67	2.76	1.34	0.55	0.79
BW20	0.79	3.35	1.57	-	1.50
BW22	0.91	4.53	1.97	0.67	2.56
BW26	1.06	5.51	2.56	0.79	4.23
BW32	1.30	5.91	2.76	1.02	6.97
BW36	1.42	6.69	2.95	-	9.08
BW45	1.77	6.69	3.15	-	15.77
BW50	1.97	7.87	3.94	-	23.81

VXK1 | Clevis Master Set

Master set for 1-leg chain slings. Adjustable style.

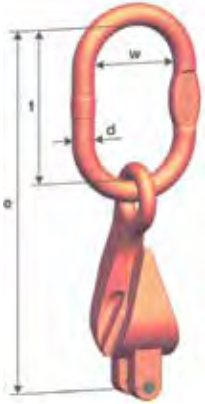

Code	WLL 90° [lb]	for chain	d [Inch]	t [Inch]	w [Inch]	e [Inch]	Weight [lb/pc.]
VXK1-70	4,300	9/32"	0.51	4.33	2.36	9.13	2.12
VXK1-100	8,800	3/8"	0.75	5.31	2.95	11.57	4.65
VXK1-130	15,000	1/2"	0.91	6.30	3.54	14.29	9.48
VXK1-160	22,600	5/8"	1.06	7.09	3.94	16.26	16.01

Example: VXK1-100 can be used for 1-leg slings with 3/8 chain.

Not to be used for basket applications

VXK2 | Clevis Master Set

Master set for 2-leg chain slings. Adjustable style.

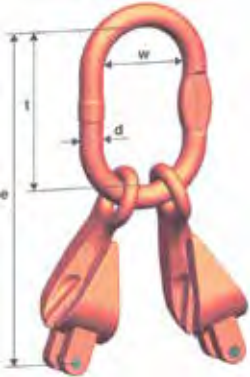

Code	WLL 90°-45° [lb]	for chain	d [Inch]	t [Inch]	w [Inch]	e [Inch]	Weight [lb/pc.]
VXK2-70	7,400	9/32"	0.63	4.33	2.36	9.13	3.90
VXK2-100	15,200	3/8"	0.91	6.30	3.54	12.56	9.04
VXK2-130	26,000	1/2"	1.06	7.09	3.94	15.08	17.33
VXK2-160	39,100	5/8"	1.30	7.87	4.33	17.05	30.30

Example: VXK 2-100 can be used for 2-leg slings with 3/8 chain.

Not to be used for basket applications

VXK4 | Clevis Master Set

Master set for 4-leg chain slings. Adjustable style.

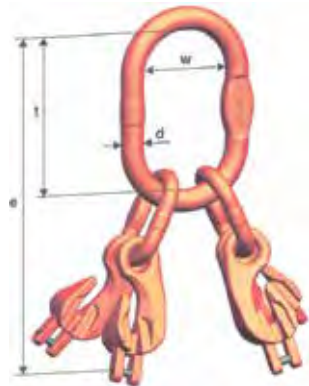

Code	WLL 90°-45° [lb]	for chain	d [Inch]	t [Inch]	w [Inch]	e [Inch]	Weight [lb/pc.]
VXK4-70	11,200	9/32"	0.91	6.30	3.54	13.86	10.67
VXK4-100	22,900	3/8"	1.06	7.09	3.94	16.69	19.45
VXK4-130	39,000	1/2"	1.30	7.87	4.33	20.39	38.06
VXK4-160	58,700	5/8"	1.42	10.24	5.51	24.92	64.52

Example: VXK 4-100 can be used for 4-leg slings with 3/8 chain.

Not to be used for basket applications

C | Connex Connecting Link, Removable

Connecting link for: Master link - chain, Chain - chain, Hook - chain.
Only for straight pull. **Not to be used on endless slings**



Code	Size	WLL [lb]	e [Inch]	c [Inch]	s [Inch]	d [Inch]	b [Inch]	g [Inch]	Weight [lb/pc.]
C5.50	7/32"	2,700	1.73	0.31	0.43	0.31	1.54	0.55	0.13
C70	9/32"	4,300	2.01	0.39	0.51	0.35	1.85	0.67	0.26
C80	5/16"	5,700	2.44	0.47	0.55	0.39	2.17	0.71	0.51
C100	3/8"	8,800	2.83	0.59	0.71	0.51	2.52	0.94	0.93
C130	1/2"	15,000	3.46	0.79	0.87	0.67	3.11	1.10	1.85
C160	5/8"	22,600	4.06	0.83	1.14	0.83	4.17	1.30	3.09
C200	3/4"	35,300	4.53	1.18	1.38	0.98	4.65	1.65	5.29
C220	7/8"	42,700	6.34	1.34	1.54	0.98	5.83	2.01	9.15
C260	1"	59,700	7.48	1.57	1.81	1.18	6.89	2.36	14.77
C320	1-1/4"	90,400	8.11	1.85	2.20	1.38	8.50	3.15	24.70

Assembly:

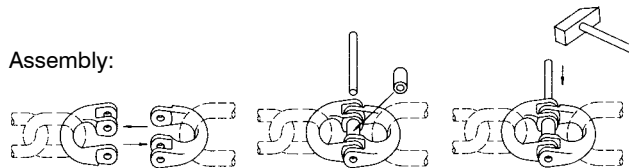

CL | Connex Connecting Link, Non-Removable

For applications where the pin must not be removed or must be secured by positive locking. Only for straight pull. **Not to be used on endless slings**



Code	Size	WLL [lb]	e [Inch]	c [Inch]	s [Inch]	d [Inch]	b [Inch]	g [Inch]	Weight [lb/pc.]
CL70	9/32"	4,300	2.01	0.39	0.51	0.35	1.85	0.67	0.26
CL100	3/8"	8,800	2.83	0.59	0.71	0.51	2.52	0.94	0.93
CL130	1/2"	15,000	3.46	0.79	0.87	0.67	3.11	1.10	1.85
CL160	5/8"	22,600	4.06	0.83	1.14	0.83	4.17	1.30	2.51

XK | Clevis Shortening Hook

Shortening hook to be used as shortener **ONLY**.

Can be mounted in any chain leg thanks to clevis connecting link. **Not to be used for basket applications**

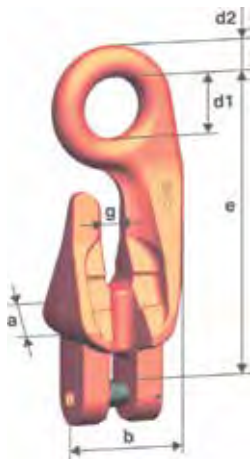

Code	Size	WLL [lb]	e [Inch]	b [Inch]	a [Inch]	d1 [Inch]	d2 [Inch]	g [Inch]	Weight [lb/pc.]
XK 5.50	7/32"	2,700	3.31	1.46	1.14	0.71	0.35	0.31	0.66
XK 70	9/32"	4,300	4.80	2.13	1.54	0.94	0.47	0.43	1.37
XK 80	5/16"	5,700	4.80	2.13	1.54	0.94	0.47	0.43	1.39
XK 100	3/8"	8,800	6.26	2.76	1.97	1.22	0.55	0.51	2.76
XK 130	1/2"	15,000	7.99	3.62	2.52	1.46	0.71	0.59	5.95
XK 160	5/8"	22,600	9.21	4.02	3.15	1.89	0.94	0.79	10.58

KHS | Clevis Sling Hook

General purpose hook, can be attached directly to the chain, therefore no need for connecting links.

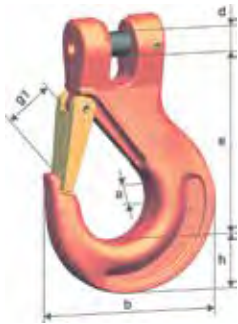

Code	Size	WLL [lb]	e [Inch]	h [Inch]	a [Inch]	d [Inch]	g1 [Inch]	b [Inch]	Weight [lb/pc.]
KHS 5.50	7/32"	2,700	2.72	0.79	0.59	0.28	0.75	2.60	0.44
KHS 70	9/32"	4,300	3.74	1.10	0.75	0.35	1.02	3.54	1.32
KHS 80	5/16"	5,700	3.74	1.10	0.75	0.39	1.02	3.54	1.32
KHS 100	3/8"	8,800	4.29	1.38	0.98	0.49	1.22	4.25	2.43
KHS 130	1/2"	15,000	5.35	1.61	1.34	0.63	1.54	5.16	4.41
KHS 160	5/8"	22,600	6.10	1.93	1.46	0.79	1.77	6.02	7.67
KHS 200	3/4"	35,300	7.24	2.09	2.01	0.94	2.09	6.97	11.03
KHS 220	7/8"	42,700	8.43	2.44	2.05	1.06	2.44	7.72	19.85

HS | Eye Sling Hook

For general lifting applications.
All hooks with forged safety catch.



Code	Size	WLL [lb]	e [Inch]	h [Inch]	a [Inch]	d1 [Inch]	d2 [Inch]	g1 [Inch]	b [Inch]	Weight [lb/pc.]
HS5.50	7/32"	2,700	3.35	0.83	0.67	0.79	0.39	0.75	2.68	0.66
HS70/80	9/32"	5,700	4.17	1.06	0.75	0.98	0.43	1.02	3.46	1.10
HS100	3/8"	8,800	5.16	1.30	1.02	1.34	0.63	1.22	4.29	2.43
HS130	1/2"	15,000	6.46	1.73	1.30	1.69	0.75	1.54	5.28	4.85
HS160	5/8"	22,600	7.20	1.97	1.57	1.97	0.98	1.77	6.10	7.72
HS200	3/4"	35,300	8.07	2.17	1.89	2.17	1.06	2.09	7.01	12.79
HS220	7/8"	42,700	8.86	2.44	1.97	2.36	1.14	2.44	7.72	17.64
HS260	1"	59,700	10.20	2.95	2.36	2.76	1.46	2.87	9.25	29.55
HS320	1-1/4"	90,400	11.77	3.82	3.23	2.60	1.77	3.43	11.46	60.64

KP | Clevis Grab Hook

For shortening of slings legs.
First clevis grab hook in Grade 100 quality on the market.
Reduction of load capacity not required.

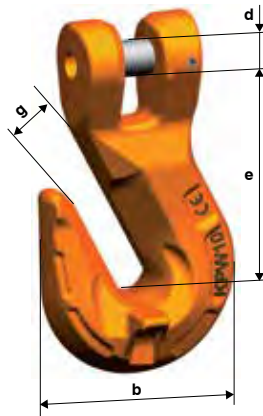

Code	Size	WLL [lb]	e [Inch]	b [Inch]	d [Inch]	g [Inch]	Weight [lb/pc.]
KP5.50	7/32"	2,700	1.77	1.85	0.28	0.31	0.42
KP70	9/32"	4,300	2.40	2.28	0.35	0.43	0.84
KP80	5/16"	5,700	2.40	2.28	0.39	0.43	0.84
KP100	3/8"	8,800	2.99	2.99	0.49	0.51	1.87
KP130	1/2"	15,000	4.09	3.98	0.63	0.67	4.19
KP160	5/8"	22,600	4.57	4.72	0.79	0.79	7.94
KP200	3/4"	35,300	5.55	5.91	0.94	0.98	13.56
KP220	7/8"	42,700	6.22	6.50	1.06	1.06	19.85

P | Grab Hook

For shortening and for slings that must not tighten.
First grab hook in Grade 100 quality on the market.
Reduction of load capacity not required.

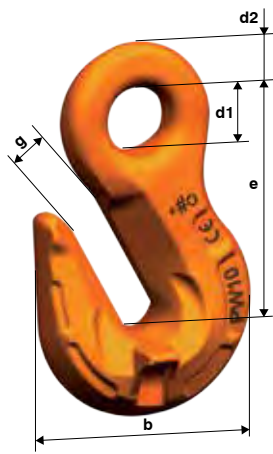

Code	Size	WLL [lb]	e [Inch]	b [Inch]	d1 [Inch]	d2 [Inch]	g [Inch]	Weight [lb/pc.]
P5.50	7/32"	2,700	2.01	1.89	0.47	0.35	0.31	0.40
P70/80	9/32"-5/16"	5,700	2.80	2.28	0.79	0.47	0.43	0.88
P100	3/8"	8,800	3.46	2.99	0.87	0.59	0.51	1.98
P130	1/2"	15,000	3.86	3.86	0.94	0.67	0.63	3.53
P160	5/8"	22,600	5.08	4.65	1.26	0.91	0.75	7.94
P200	3/4"	35,300	5.94	5.91	1.42	1.06	0.98	13.56
P220	7/8"	42,700	6.69	6.50	1.65	1.22	1.06	18.30
P260	1"	59,700	7.91	7.68	1.97	1.46	1.26	30.43
P320	1-1/4"	90,400	9.57	9.53	2.36	1.69	1.50	55.13

PS | Grab Hook With Safety Catch

Shortening hook with safety catch against accidental release of the chain. First grab hook with safety catch in Grade 100 quality on the market. Reduction of load capacity not required.

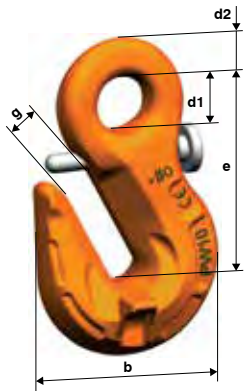

Code	Size	WLL [lb]	e [Inch]	b [Inch]	d1 [Inch]	d2 [Inch]	g [Inch]	Weight [lb/pc.]
PS70/80	9/32" - 5/16"	5,700	2.80	2.28	0.79	0.47	0.43	0.88
PS100	3/8"	8,800	3.46	2.99	0.87	0.59	0.51	1.98
PS130	1/2"	15,000	3.86	3.86	0.94	0.67	0.63	3.53
PS160	5/8"	22,600	5.08	4.65	1.26	0.91	0.75	7.94

KPS | Clevis Grab Hook with Safety Catch

For shortening of sling legs and chain. The first clevis hook in Grade 100 quality on the market. Reduction of load capacity not required.



NEW

Code	Size	WLL [lb]	e [Inch]	b [Inch]	d [Inch]	g [Inch]	Weight [lb/pc.]
KPSW 70	9/32"	4,300	2.48	2.24	0.35	0.35	0.97
KPSW 80	5/16"	5,700	2.48	2.24	0.39	0.35	0.97
KPSW 100	3/8"	8,800	3.07	2.80	0.49	0.47	1.87
KPSW 130	1/2"	15,000	3.66	3.62	0.63	0.59	3.86
KPSW 160	5/8"	22,600	4.53	4.45	0.79	0.75	7.28



WLHB | Swivel Safety Hook with Bearings

Swivel hook does rotate under load.

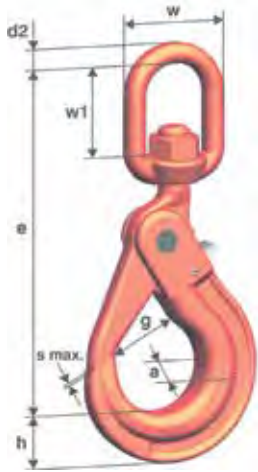

Code	WLL [lb]	e [Inch]	h [Inch]	a [Inch]	w [Inch]	w1 [Inch]	d2 [Inch]	g [Inch]	s max. [Inch]	Weight [lb/pc.]
WLHB70/80	5,700	7.13	1.02	0.79	1.38	1.38	0.51	1.34	0.04	2.43
WLHB100	8,800	8.58	1.18	1.14	1.65	1.57	0.63	1.77	0.04	4.41
WLHB130	15,000	10.59	1.57	1.38	1.93	1.85	0.79	2.05	0.08	8.82
WLHB160	22,600	12.56	1.97	1.61	2.36	2.36	0.94	2.36	0.08	14.99

WLH | Swivel Safety Hook

Swivel hook **does not rotate under load.**

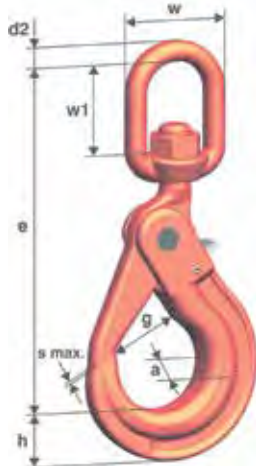

Code	WLL [lb]	e [Inch]	h [Inch]	a [Inch]	w [Inch]	w1 [Inch]	d2 [Inch]	g [Inch]	s max. [Inch]	Weight [lb/pc.]
WLH70/80	5,700	7.13	1.02	0.79	1.38	1.38	0.51	1.34	0.04	2.43
WLH100	8,800	8.58	1.18	1.14	1.65	1.57	0.63	1.77	0.04	4.41
WLH130	15,000	10.59	1.57	1.38	1.93	1.85	0.79	2.05	0.08	8.82
WLH160	22,600	12.56	1.97	1.61	2.36	2.36	0.94	2.36	0.08	14.99

KLH | Clevis Safety Hook

Closes and locks automatically under load.

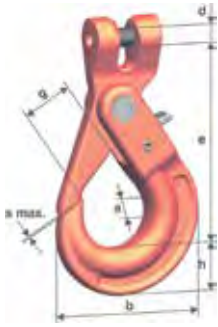

Code	Size	WLL [lb]	e [Inch]	h [Inch]	a [Inch]	b [Inch]	d [Inch]	g [Inch]	s max. [Inch]	Weight [lb/pc.]
KLH5.50	7/32"	2,700	3.70	0.79	0.67	2.80	0.28	1.10	0.04	1.10
KLH70	9/32"	4,300	4.84	1.02	0.79	3.46	0.35	1.34	0.04	1.98
KLH80	5/16"	5,700	4.84	1.02	0.79	3.46	0.39	1.34	0.04	1.98
KLH100	3/8"	8,800	5.67	1.18	1.14	4.21	0.49	1.77	0.04	3.53
KLH130	1/2"	15,000	7.09	1.57	1.38	5.43	0.63	2.05	0.08	6.39
KLH160	5/8"	22,600	8.58	1.97	1.61	6.61	0.79	2.36	0.08	12.79
KLH200	3/4"	35,300	10.20	2.44	1.97	7.64	0.94	2.76	0.08	21.83
KLH220	7/8"	42,700	11.26	2.56	2.05	8.31	1.06	3.19	0.08	28.22
KLH 260	1"	59,700	13.31	3.11	2.40	9.96	1.30	3.94	0.08	45.20

LH | Safety Hook

Large eye, therefore suitable for wire ropes and webbing slings.

Automatically closes and locks under load, and requires the load to be grounded before load can be released.

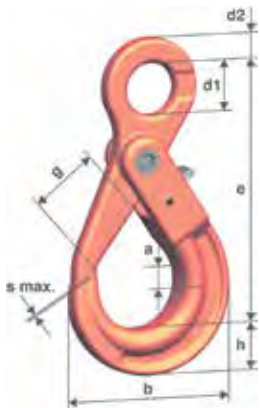

Code	Size	WLL [lb]	e [Inch]	h [Inch]	a [Inch]	b [Inch]	d1 [Inch]	d2 [Inch]	g [Inch]	s max. [Inch]	Weight [lb/pc.]
LH5.50	7/32"	2,700	4.33	0.79	0.67	2.80	0.83	0.43	1.10	0.04	1.10
LH70/80	9/32" ~ 5/16"	5,700	5.35	1.02	0.79	3.46	0.98	0.47	1.34	0.04	1.98
LH100	3/8"	8,800	6.65	1.18	1.14	4.21	1.38	0.59	1.77	0.04	3.31
LH130	1/2"	15,000	8.07	1.57	1.38	5.43	1.57	0.79	2.05	0.08	5.95
LH160	5/8"	22,600	9.88	1.97	1.61	6.61	1.97	1.06	2.36	0.08	12.57
LH200	3/4"	35,300	11.42	2.44	1.97	7.64	2.36	1.18	2.76	0.08	21.61
LH220	7/8"	42,700	12.68	2.56	2.05	8.31	2.76	1.26	3.19	0.08	27.34

KF | Clevis Foundry Hook

Before using the hook, check whether hooks without safety catch are allowed to be used for this particular application.



Code	Size	WLL [lb]	e [Inch]	h [Inch]	a [Inch]	g [Inch]	d [Inch]	b [Inch]	Weight [lb/pc.]
KF 70	9/32"	4,300	4.76	1.14	0.98	2.52	0.35	4.65	2.21
KF 80	5/16"	5,700	4.72	1.14	0.98	2.52	0.39	4.65	2.21
KF 100	3/8"	8,800	5.51	1.38	1.26	2.99	0.49	5.63	3.92
KF 130	1/2"	15,000	6.69	1.65	1.57	3.50	0.63	6.69	6.53

F | Foundry Hook

Before using the hook, check whether hooks without safety catch are allowed to be used for this particular application.



Code	Size	WLL [lb]	e [Inch]	h [Inch]	a [Inch]	d1 [Inch]	d2 [Inch]	g [Inch]	b [Inch]	Weight [lb/pc.]
F70/80	9/32"-5/16"	5,700	5.16	1.14	0.98	0.94	0.43	2.52	4.65	2.03
F100	3/8"	8,800	6.22	1.38	1.26	1.22	0.55	2.99	5.63	3.90
F130	1/2"	15,000	7.48	1.65	1.57	1.54	0.67	3.50	6.69	6.22
F160	5/8"	22,600	8.82	1.97	1.81	1.85	0.87	4.02	7.87	11.09
F200	3/4"	35,300	10.24	2.40	2.13	2.20	1.10	4.49	9.09	16.76

BW | Sheet Metal Plate Hook

For lifting sheet metal stacks and boards.
Use min. 3-leg chain sling.

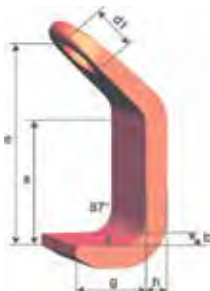

Code	Size	WLL [lb]	e [Inch]	s [Inch]	b [Inch]	h [Inch]	d1 [Inch]	g [Inch]	Weight [lb/pc.]
BW70/80	9/32"-5/16"	5,700	5.16	3.15	1.97	0.71	1.10	2.17	3.31
BW100	3/8"	8,800	6.61	3.94	2.76	0.79	1.42	2.56	6.17
BW130	1/2"	15,000	8.15	5.12	3.15	1.02	1.57	3.54	11.69
BW160	5/8"	22,600	10.28	6.30	3.94	1.30	1.97	4.33	23.15
BW200	3/4"	35,300	11.89	7.28	4.72	1.57	2.36	5.12	38.59
BW220	7/8"	42,700	14.29	8.66	5.51	1.97	2.95	5.91	67.25

CAR | Round Sling Connecting Link

Link for webbing slings mounted in one connex half.
Reduced risk of damage thanks to wide surface.



Code	Size	WLL [lb]	a [Inch]	e [Inch]	c [Inch]	d [Inch]	b [Inch]	s [Inch]	Weight [lb/pc.]
CAR80	5/16"	5,700	1.14	2.60	0.47	0.39	2.56	0.71	0.88
CAR100	3/8"	8,800	1.57	3.19	0.59	0.51	3.23	0.83	1.21
CAR130	1/2"	15,000	1.97	4.09	0.79	0.67	3.94	1.10	2.65
CAR160	5/8"	22,600	1.85	4.45	0.83	0.83	4.33	1.57	4.41
CAR220	7/8"	42,700	4.29	7.01	1.14	1.06	8.46	2.32	14.33

KO | Clevis Reeving Link

Master set for 1-leg chains. No danger of confusing this master link with any other master link. Can also be used as an end link.

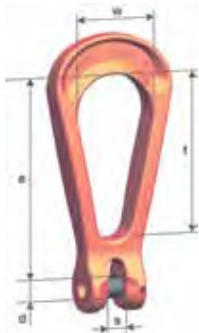

Code	Size	WLL [lb]	e [Inch]	t [Inch]	w [Inch]	d [Inch]	s [Inch]	Weight [lb/pc.]
KO70	9/32"	4,300	3.62	2.76	1.34	0.35	0.35	0.62
KO80	5/16"	5,700	3.58	2.76	1.34	0.39	0.35	0.66
KO100	3/8"	8,800	5.04	4.02	1.97	0.49	0.47	1.54
KO130	1/2"	15,000	6.65	5.35	2.60	0.63	0.59	3.09
KO160	5/8"	22,600	8.43	6.77	3.27	0.79	0.71	6.04

RLB | Load Binder

For Pewag Winner Connex System.
Load Binder with optimized lever length.

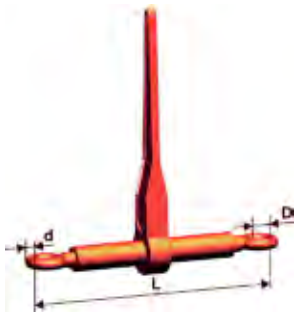

Code	Size	L Length closed [inch]	L Length open [inch]	Tension range [inch]	length of lever [inch]	D [inch]	d [inch]	Weight [lb/pc.]
7G100RLB	9/32"	13.98	19.69	5.71	9.33	0.79	0.63	7.06
10G100RLB	3/8"	14.37	20.08	5.71	13.98	1.02	0.71	8.38
13G100RLB	1/2"	22.68	34.09	11.42	14.13	1.22	0.87	21.83

Image as shown is for dimensional purposes only. Load binders sold assembled (connector and grab hook included).

KCH | Clevis C-Hook

Suitable for simple and fast hooking and removal.
Only for applications without safety catch requirement.



Code	Size	WLL [lb]	e [Inch]	h [Inch]	d [Inch]	b [Inch]	g [Inch]	Weight [lb/pc.]
KCH70	9/32"	4,300	3.58	1.10	0.35	2.91	0.79	1.10
KCH80	5/16"	5,700	3.54	1.10	0.39	2.91	0.79	1.10
KCH100	3/8"	8,800	5.08	1.54	0.49	4.21	1.10	3.09
KCH130	1/2"	15,000	6.54	2.01	0.63	5.39	1.61	6.62
KCH160	5/8"	22,600	8.07	2.36	0.79	6.54	1.77	11.69

KSCH | Clevis Shackle

Directly attached to the chain. Allows direct connection with other components such as spreader beams.

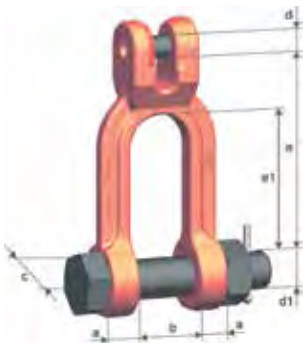

Code	Size	WLL [lb]	e [Inch]	e1 [Inch]	b min [Inch]	a [Inch]	d [Inch]	c [Inch]	d1 [Inch]	Weight [lb/pc.]
KSCH70	9/32"	4,300	2.99	2.13	1.02	0.47	0.35	1.22	0.63	1.08
KSCH80	5/16"	5,700	2.99	2.13	1.02	0.47	0.39	1.22	0.63	1.08
KSCH100	3/8"	8,800	4.13	2.99	1.26	0.63	0.49	1.54	0.79	2.09
KSCH130	1/2"	15,000	4.45	3.03	1.65	0.83	0.63	1.97	0.94	4.17

C | Bolts + Safety Catch



Code	for Connex type
CBH 50 Grade 100	C 50
CBH 60 Grade 100	C 60
CBH 70 Grade 100	C 70
CBH 80 Grade 100	C 80, CAR 80
CBH 100 Grade 100	C 100, CAR 100
CBH 130 Grade 100	C 130, CAR 130
CBH 160 Grade 100	C 160, CAR 160
CBH 190/200 Grade 100	C 190/200
CBH 220 Grade 100	C 220, CAR 220
CBH 260 Grade 100	C 260
CBH 320 Grade 100	C 320

CL | Retaining Sleeves



Code	for Connex type
CLBH 70 Grade 100	CL 70
CLBH 100 Grade 100	CL 100
CLBH 130 Grade 100	CL 130
CLBH 160 Grade 100	CL 160

PS | Safety Catches



Code	for hook type
PSG70/80 Grade 100	PS 70/80
PSG100 Grade 100	PS 100
PSG130 Grade 100	PS 130
PSG160 Grade 100	PS 160

LH | Trigger Sets



Code	for hook type
VLH 50/60 Grade 100	LH 50/60, KLH 50/60
VLH 70/80 Grade 100	LH 70/80, KLH 70, KLH 80
VLH 100 Grade 100	LH 100, KLH 100
VLH 130 Grade 100	LH 130, KLH 130
VLH 160 Grade 100	LH 160, KLH 160
VLH 190/200/220/260 Grade 100	LH 190/200, LH 220, KLH 190/200

SFG | Safety Catch Sets



Code	for hook type
SFG5	HS50/60, KHS50/60
SFG7/8	HS70/80, KHS70/80
SFG10	HS100, KHS100
SFG13	HS130, KHS130
SFG16	HS160, KHS160
SFG19/20	HS190/200, KHS190/200
SFG22	HS220, KHS220
SFG26/32	HS260, HS320

PIN | Clevis Load Pins Replacements



Code	For Clevis hook size
PIN50/60	3/16"
PIN70	9/32"
PIN80	5/16"
PIN100	3/8"
PIN130	1/2"
PIN160	5/8"
PIN190	3/4"
PIN220	7/8"

Sling ID Tag

Stainless Steel ID Tag



Code	for hook type
Sling warning single leg	90 Degrees
Sling warning multiple legs	30, 45, 60 Degrees

Chain Gauge



Only for use with pewag chain



Grade 80

Chain and Accessories



NI | Alloy Chain Made By pewag



Code	Material thickness dn [Inch]	Standard delivery length [feet]	Pitch t [Inch]	Inside b1 min. [Inch]	Outside b2 max. [Inch]	WLL [lb]	Breaking force [lb]	Weight [lb/ft]
NI5.5	0.22	400	0.680	0.319	0.787	2,100	8,400	0.470
NI7	0.28	800	0.826	0.375	0.992	3,500	14,000	0.738
NI8	0.32	500	0.945	0.430	1.134	4,500	18,000	0.939
NI10	0.39	400	1.181	0.531	1.417	7,100	28,400	1.475
NI13	0.51	200	1.535	0.689	1.843	12,000	48,000	2.548
NI16	0.63	150	1.890	0.846	2.268	18,100	72,400	3.830
NI20	0.79	100	2.440	1.008	2.776	28,300	113,200	5.780
NI22	0.87	100	2.598	1.161	3.118	34,200	136,800	7.324
NI26	1.02	100	3.071	1.378	3.704	47,700	190,800	10.214
NI32	1.26	50	3.780	1.657	4.646	72,300	289,200	15.455

AR | Clevis Sling Hook

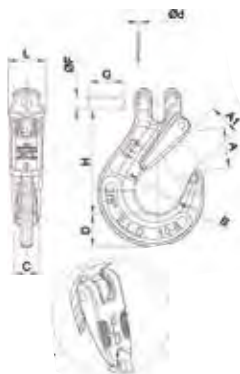

Code	WLL [lb]	Chain size	Dimension										Weight [lb/pc.]
			A [Inch]	A1 i [Inch]	B [Inch]	C [Inch]	D [Inch]	ØF [Inch]	G [Inch]	Ød [Inch]	H [Inch]	L [Inch]	
179107AR	3,500	9/32" - 5/16"	1.14	0.94	1.42	0.79	1.22	0.39	1.10	0.12	3.35	1.18	1.38
179110AR	7,100	3/8"	1.50	1.26	1.77	0.94	1.38	0.49	1.38	0.12	4.13	1.54	2.64
179113AR	12,100	1/2"	1.81	1.57	2.28	0.98	1.65	0.63	1.50	0.16	5.20	1.69	4.73
179116AR	18,100	5/8"	2.09	1.69	2.52	1.26	1.89	0.79	1.97	0.20	5.83	2.05	7.87

Design factor 4:1

AR | Clevis Grab Hook

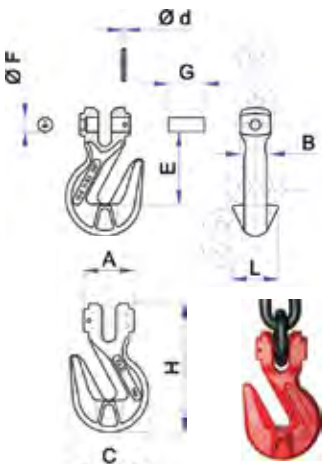

Alloy Steel		Chain size	Size									Weight [lb/pc.]
Code	WLL [lb]		A [Inch]	B [Inch]	C [Inch]	Ød [Inch]	E [Inch]	ØF [Inch]	G [Inch]	H [Inch]	L [Inch]	
184007AR	3,500	9/32"	1.42	0.87	2.13	0.12	2.13	0.39	1.10	3.78	1.18	0.88
184010AR	7,100	3/8"	1.81	1.10	2.95	0.12	2.76	0.49	1.38	4.88	1.69	1.85
184013AR	12,100	1/2"	2.24	1.42	3.66	0.16	3.39	0.63	1.50	6.06	2.05	3.56
184016AR	18,100	5/8"	2.76	1.65	4.25	0.20	3.98	0.79	1.97	7.05	2.52	5.17

Design factor 4:1

AR | Clevis Grab Hook with Safety Pin

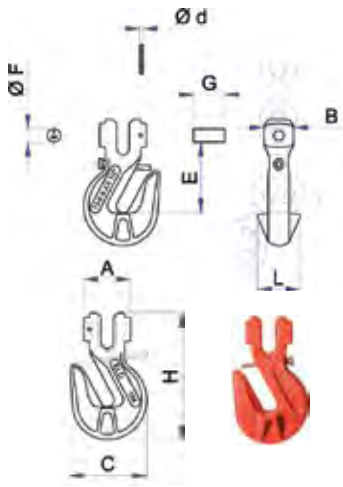

Alloy steel			Size									Weight [lb/pc.]
Code	WLL [lb]	Chain size	A [Inch]	B [Inch]	C [Inch]	Ød [Inch]	E [Inch]	ØF [Inch]	G [Inch]	H [Inch]	L [Inch]	
184L07AR	3,500	9/32"	1.42	0.87	2.13	0.12	2.13	0.39	1.10	3.78	1.18	0.88
184L10AR	7,100	3/8"	1.81	1.10	2.95	0.12	2.76	0.49	1.38	4.88	1.69	1.85
184L13AR	12,000	1/2"	2.24	1.42	3.66	0.16	3.39	0.63	1.50	6.06	2.05	3.56
184L16AR	18,100	5/8"	2.76	1.65	4.25	0.20	3.98	0.79	1.97	7.05	2.52	5.17

Design factor 4:1

R | Connecting Links

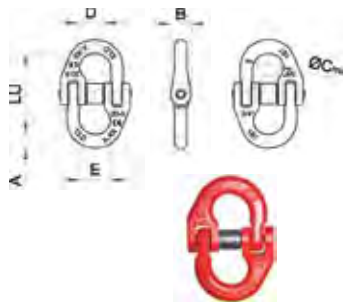

Alloy steel			Chain size	Size					Weight [lb/pc.]
Code	WLL [lb]		A [Inch]	B [Inch]	ØC [Inch]	D [Inch]	E [Inch]	LU [Inch]	
1810078R	3,500	9/32"-5/16"	0.37	0.53	0.71	0.79	0.91	2.17	0.36
1810108R	7,100	3/8"	0.47	0.67	0.87	0.98	1.10	2.64	0.68
1810138R	12,000	1/2"	0.67	0.87	1.02	1.18	1.34	3.31	1.46
1810168R	18,100	5/8"	0.87	1.10	1.26	1.42	1.61	4.09	2.49

Design factor 4:1

DS/ES | Eye Sling Hook



Carbon steel Grade 40		Alloy steel Grade 80		Size									Weight [lb/pc.]	
Code	WLL [metric t]	CODE	WLL [metric t]	A [Inch]	B [Inch]	C [Inch]	D [Inch]	D1 [Inch]	E [Inch]	F [Inch]	G [Inch]	H [Inch]	L [Inch]	
101007DS	0.8	101010ES	1.25	0.37	0.75	3.03	0.91	0.79	0.83	0.59	0.59	1.22	3.23	0.73
101010DS	1	101015ES	1.6	0.43	0.98	3.23	1.02	0.87	0.91	0.71	0.71	1.34	3.66	1.01
101015DS	1.6	101020ES	2.5	0.51	1.06	3.70	1.06	0.91	1.06	0.91	0.91	1.50	4.13	1.65
101020DS	2	101030ES	3.2	0.59	1.26	4.17	1.22	1.06	1.22	0.91	0.94	1.65	4.76	2.31
101030DS	3.2	101045ES	5.4	0.71	1.50	5.20	1.57	1.38	1.46	1.14	1.18	1.97	5.75	4.09
101050DS	5	101070ES	8	0.91	2.01	6.50	2.01	1.69	1.93	1.46	1.46	2.44	7.36	8.69
101075DS	7.5	101110ES	11.5	1.14	2.52	7.80	2.28	2.09	2.36	1.69	1.81	2.95	9.06	15.84
101100DS	10	101150ES	16	1.3	2.76	8.74	2.60	2.28	2.64	2.05	2.24	3.31	10.04	22.44
	15	101200ES	22	1.54	3.54	11.14	3.43	3.07	3.15	2.52	2.56	4.33	12.60	44.66

Grade 40: design factor 5:1 - Grade 80 design factor 4:1



DS/ES | Swivel Hook · Carbon and Alloy

Hook can not be rotated under a load

Code	Carbon steel Grade 40		Alloy steel Grade 80		Size													Weight [lb/pc.]
	WLL [Ton]	Code	WLL [Ton]	A [inch]	B [inch]	C [inch]	D [inch]	D1 [inch]	E [inch]	F [inch]	G [inch]	H [inch]	L [inch]	M [inch]	N [inch]	P [inch]	R [inch]	
		147010ES	1.25	0.31	1.06	3.03	0.94	0.79	0.83	0.59	0.59	1.22	4.57	1.22	2.01	1.18	0.39	1.03
147010DS	1	147015ES	1.6	0.39	1.30	3.23	1.02	0.87	0.91	0.71	0.71	1.34	5.51	1.50	2.48	1.54	0.49	2.20
147015DS	1.6	147020ES	2.5	0.49	1.65	3.70	1.06	0.91	1.06	0.91	0.91	1.50	6.42	1.85	3.11	1.89	0.63	3.08
147020DS	2	147030ES	3.2	0.49	1.57	4.17	1.26	1.06	1.22	0.91	0.95	1.65	6.77	1.85	3.11	1.89	0.63	3.65
147030DS	3.2	147045ES	5.4	0.59	1.97	5.20	1.57	1.38	1.46	1.14	1.19	1.97	8.39	2.28	3.78	2.36	0.75	8.03
147050DS	5	147070ES	8	0.69	2.56	6.50	2.01	1.69	1.93	1.46	1.46	2.44	10.47	2.83	4.72	2.76	0.94	12.91
147075DS	7.5	147110ES	11.5	0.87	2.68	7.80	2.28	2.09	2.36	1.69	1.82	2.95	12.20	3.23	5.35	3.23	1.06	21.45
147100DS	10	147150ES	16	1.38	3.39	8.74	2.60	2.28	2.64	2.05	2.25	3.31	13.54	3.78	6.50	4.14	1.38	33.66
		147200ES	22	1.89	4.49	11.13	3.35	3.07	3.15	2.52	2.56	4.33	16.81	4.73	7.88	5.12	0.49	59.40

Grade 40: Design factor 5:1 – Grade 80: Design factor 4:1

AS | Swivel Locking Hook

Hook can be rotated under a load



Code	Alloy steel		Chain size	Size											Weight [lb/pc.]
	WLL [lb]	Code		A [inch]	B [inch]	D [inch]	E [inch]	F [inch]	H [inch]	L [inch]	M [inch]	N [inch]	P [inch]	R [inch]	
102007AS	2		9/32"	0.39	1.22	1.30	1.02	0.79	1.77	7.40	1.50	2.48	1.54	0.49	2.90
102010AS	3.2		3/8"	0.49	1.57	1.73	1.38	1.06	2.28	8.98	1.85	3.11	1.89	0.63	5.06
102013AS	5.4		1/2"	0.59	1.97	2.13	1.61	1.18	2.80	11.22	2.28	3.78	2.36	0.75	9.68
102016AS	8		5/8"	0.68	2.56	2.60	2.09	1.38	3.31	13.27	2.83	4.72	2.36	0.94	17.60

Design factor 4:1

AN | Sliding Choker Hook

Latch not included



Code	Alloy steel		Wire rope size	Size								Weight [lb/pc.]
	WLL [metric ton]	Code		A [inch]	B [inch]	C [inch]	D [inch]	E [inch]	F [inch]	G [inch]	H [inch]	
112015AN	1.5		3/8"-1/2"	0.63	2.64	2.01	0.94	0.79	0.94	5.12	0.94	1.32
112020AN	2		5/8"	0.79	3.07	2.44	1.06	0.94	1.14	5.79	0.98	2.09
112030AN	3		3/4"	0.98	4.06	2.76	1.34	1.18	1.42	7.01	1.30	4.40
112050AN	5		7/8"-1"	1.26	5.04	3.15	1.69	1.61	1.77	8.27	1.57	7.57

Design factor 5:1

BH | Bucket Hook

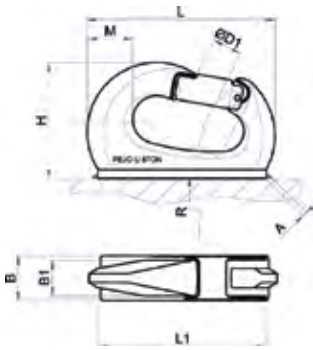

Code	WLL [ton]	B1 [inch]	M [inch]	L [inch]	L1 [inch]	H [inch]	B [inch]	Ø D1 [inch]	A [inch]	Weight [lb/pc.]
BH-1	1	0.83	0.87	4.13	3.90	2.95	0.98	0.91	0.16	1.30
BH-2	2	0.91	1.14	4.84	4.29	3.39	1.18	1.06	0.16	2.27
BH-3	3	1.14	1.38	5.71	5.24	3.98	1.38	1.22	0.24	4.22
BH-4	4	1.18	1.26	5.98	5.59	4.21	1.38	1.22	0.24	4.60
BH-6	6	1.40	1.77	8.07	7.28	5.00	1.57	1.57	0.31	8.29
BH-8	8	1.57	1.83	8.50	8.07	5.47	1.97	1.57	0.31	11.73

Design Factor 4:1

BHC | Bucket Hook



Code	WLL [ton]	B1 [inch]	M [inch]	L [inch]	L1 [inch]	H [inch]	B [inch]	D1 [inch]	A [inch]	Weight [lb/pc.]
BH-C10	10	1.73	2.67	10.31	6.30	6.69	2.56	1.97	0.31	16.32
BH-C18	18	2.12	2.95	11.42	7.09	7.48	3.15	1.97	0.39	24.02

Design factor 4:1

DS/ES | Shank Hook

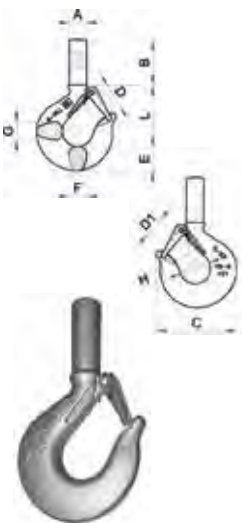

Code	Carbon steel Grade 40		Alloy steel Grade 80		Size									Weight [lb/pc.]
	WLL [ton]	Code	WLL [ton]	A [inch]	B [inch]	C [inch]	D [inch]	D1 [inch]	E [inch]	F [inch]	G [inch]	H [inch]	L [inch]	
121007DS	0.8	-	-	0.59	1.93	3.03	0.94	0.79	0.83	0.59	0.59	1.22	2.32	0.77
121020DS	2	121030ES	3.2	0.91	2.72	4.17	1.26	1.06	1.22	0.91	0.94	1.65	3.23	2.42
121030DS	3.2	121045ES	5.4	1.14	3.19	5.20	1.57	1.38	1.46	1.14	1.18	1.97	3.98	4.47
121050DS	5.4	121070ES	8	1.42	3.62	6.50	2.01	1.69	1.93	1.46	1.46	2.44	4.96	8.58
121075DS	7.5	121110ES	11.5	1.69	3.98	7.80	2.28	2.09	2.36	1.69	1.81	2.95	6.18	15.40
121100DS	10	121150ES	16	1.89	4.41	8.74	2.60	2.28	2.64	2.05	2.24	3.31	6.57	21.23
-	-	121200ES	22	2.32	5.31	11.14	3.43	3.07	3.15	2.52	2.56	4.33	8.27	40.70
-	-	121300ES	30	3.35	9.61	13.35	3.82	3.43	3.70	3.15	3.15	4.72	9.84	82.50

Grade 40: Design factor 5:1 – Grade 80: Design factor 4:1



SP/SB | Shackles

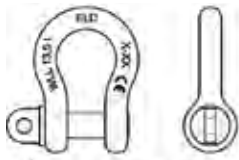

Screwed pin - 122 series

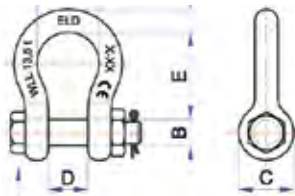

Bolt type pin with hexagon nut and split cotter pin - 123 series

Code	WLL [ton]	Size [inch]	Size (Tolerances: up 1t to 2t ± 1; up 3,25t to 25t ± 2,5; more ± 3)						Weight [lb/pc.]		
			Screw pin	Safety bolt	A [inch]	B [inch]	C [inch]	D [inch]	E [inch]	F	Screw pin
122010SP	123010SB	1	3/8"	0.39	0.43	0.91	0.67	1.44	1.02	0.29	0.33
122015SP	123015SB	1.5	7/16"	0.43	0.47	1.02	0.73	1.69	1.14	0.46	0.51
122020SP	123020SB	2	1/2"	0.53	0.63	1.34	0.87	2.01	1.26	0.75	0.77
122032SP	123032SB	3.25	5/8"	0.63	0.75	1.57	1.06	2.52	1.69	1.39	1.61
122047SP	123047SB	4.75	3/4"	0.75	0.87	1.85	1.22	2.99	2.01	2.20	2.42
122065SP	123065SB	6.50	7/8"	0.87	0.98	2.09	1.42	3.27	2.28	3.47	3.74
122085SP	123085SB	8.50	1"	0.98	1.10	2.36	1.69	3.74	2.68	4.88	5.32
122095SP	123095SB	9.50	1 1/8"	1.10	1.26	2.64	1.85	4.25	2.95	7.26	8.05
122120SP	123120SB	12	1 1/4"	1.26	1.38	2.91	2.01	4.53	3.27	9.55	11.04
122135SP	123135SB	13.50	1 3/8"	1.38	1.50	3.15	2.24	5.24	3.62	13.46	14.52
122170SP	123170SB	17	1 1/2"	1.50	1.65	3.50	2.36	5.75	3.90	16.94	19.36
122250SP	123250SB	25	1 3/4"	1.77	1.97	4.09	2.91	7.01	4.96	28.60	33.00

Design factor 5:1

DS/ES | Latch Kits For Sling Hooks



Code	Size				WLL For hook type	
	A [inch]	B [inch]	C [inch]	D [inch]	Carbon steel [ton]	Alloy steel [ton]
1DS0D1	1.56	1.28	0.67	0.16	0.75	1.25
1DS0D2	1.71	1.40	0.91	0.16	1.00	1.60
1DS0D3	1.93	1.61	0.98	0.16	1.60 / 2	2.50 / 3.2
1DS0D4	2.42	2.03	1.14	0.20	3.2	5.4
1DS0D5	3.05	2.66	1.38	0.20	5	8.00
1DS0D6	3.43	2.99	1.46	0.24	7.50	11.50
1DS0D7	3.78	3.37	1.93	0.24	10	16.00
1DS0D8	5.16	4.57	2.13	0.24		22.00
1DS0D9	6.00	5.31	2.52	0.31	--	30.00

KR | Triger for Safety Hook

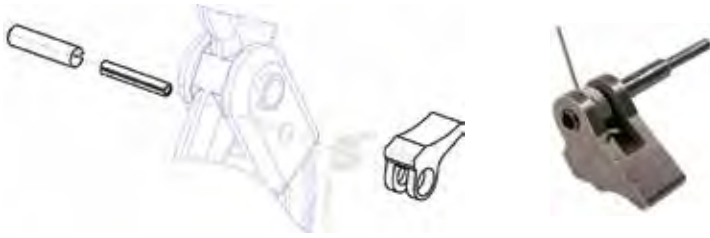

Triger for Swivel Safety Hook
Grade 80

Code	Size
102007KR	9/32"
102010KR	3/8"
102013KR	1/2"
102016KR	5/8"

SPU | Latch for style BH

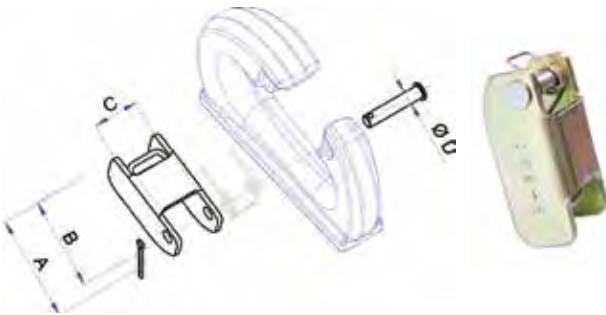

Code	Size				Fits Bucket Hook Style "BH"
	A [inch]	B [inch]	C [inch]	D [inch]	
SPU201	1.83	1.63	0.79	0.20	BH-1
SPU202	2.24	1.97	1.02	0.24	BH-3
SPU203	2.81	2.48	1.38	0.31	BH-4 & BH-5
SPU206	3.39	2.91	1.65	0.39	BH-8 & BH-10

Electrogalvanized

SPC | Latch for style BH-C

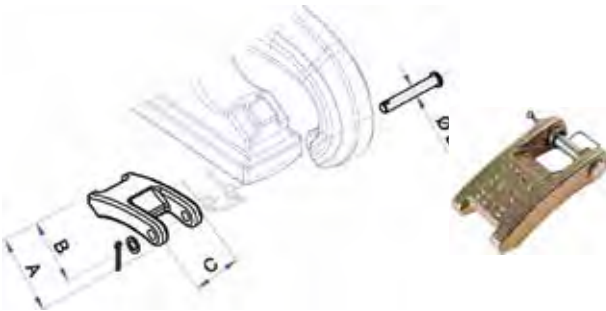

Code	Size				For Bucket Hook Style "C"
	A [inch]	B [inch]	C [inch]	D [inch]	
SPC204/206	2.44	2.16	1.33	0.23	BH-C10
SPC215	3.30	2.91	1.73	0.31	BH-C18

Electrogalvanized

AN | Load pins

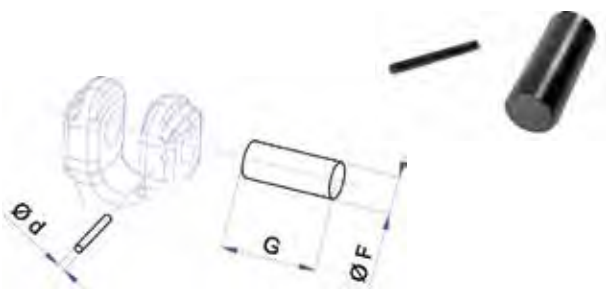

Code	F [inch]	G [inch]	d [inch]	Chain Size (For Grade 80 Clevis Hooks)
1PE107AN	0.39	1.10	0.12	9/32"-5/16"
1PE110AN	0.49	1.38	0.12	3/8"
1PE113AN	0.63	1.50	0.16	1/2"
1PE116AN	0.79	1.97	0.20	5/8"
1PE120AN	0.94	2.36	0.20	3/4"



Grade 63 Stainless Steel

Chain and Accessories



Capacities

Design factor 4:1		1-leg chains		2-leg chains				3- + 4-leg chains		
Angle of inclination:		90°	60°	45°	30°	60°	45°	30°		
Load factor:		1	1.7	1.4	1	2.6	2.1	1.45		
Code	Nominal Dimension / Trade Size	Working load limit <i>(lb)</i>								
WOX5	3/16"	1,400	2,400	2,000	1,400	3,600	2,900	2,100		
WOX7	9/32"	2,700	4,600	3,800	2,700	7,000	5,700	4,000		
WOX10	3/8"	5,500	9,300	7,700	5,500	14,300	11,500	8,200		
WOX13	1/2"	9,300	15,800	13,000	9,300	24,200	19,500	13,900		
WOX16	5/8"	13,900	23,600	19,500	13,900	36,100	29,200	20,800		

WOX | Lifting Chain



Code	Nominal diameter <i>[dn]</i>	Standard delivery length <i>[feet]</i>	Pitch <i>t</i> <i>[inch]</i>	Inside width <i>b1 min</i> <i>[inch]</i>	Outside width <i>b2 max.</i> <i>[inch]</i>	WLL <i>[lb]</i>	Breaking force <i>[lb]</i>	Weight <i>[lb/ft]</i>
WOX5	3/16"	200	0.63	0.31	0.75	1,400	5,600	0.38
WOX7	9/32"	200	0.83	0.39	0.98	2,700	10,800	0.74
WOX10	3/8"	200	1.18	0.55	1.42	5,500	22,000	1.48
WOX13	1/2"	200	1.54	0.71	1.85	9,300	37,200	2.55
WOX16	5/8"	100	1.89	0.87	2.28	13,900	55,600	3.83

CWI | Connecting Link

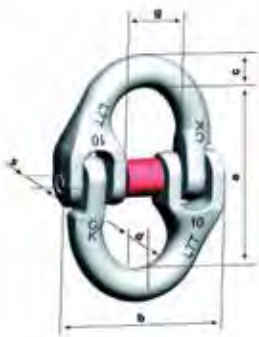

Code	WLL <i>[lb]</i>	e <i>[inch]</i>	c <i>[inch]</i>	s <i>[inch]</i>	d <i>[inch]</i>	b <i>[inch]</i>	g <i>[inch]</i>	Weight <i>[lb/pc.]</i>
CWI5	1,400	1.42	0.28	0.39	0.28	1.34	0.51	0.13
CWI7	2,700	2.13	0.35	0.51	0.35	2.01	0.67	0.31
CWI10	5,500	2.87	0.51	0.71	0.51	2.76	0.98	0.81
CWI13	9,300	3.62	0.67	0.91	0.67	3.39	1.14	1.67
CWI16	13,900	4.09	0.83	1.26	0.79	4.13	1.46	3.10

HSWI | Eye Sling Hook



Code	WLL [lb]	e [inch]	h [inch]	a [inch]	d1 [inch]	d2 [inch]	g1 [inch]	b [inch]	Weight [lb/pc.]
HSWI5	2,000	3.31	0.79	0.55	0.83	0.31	0.87	2.64	0.55
HSWI7	3,500	4.41	1.14	0.79	1.06	0.51	1.26	3.86	1.54
HSWI10	5,500	5.24	1.30	1.10	1.46	0.59	1.54	4.53	2.97
HSWI13	9,300	6.77	1.69	1.38	1.89	0.71	2.01	5.79	5.72
HSWI16	13,900	8.39	2.01	1.73	2.17	0.94	2.60	7.17	10.56

AWI | Master Link



Code	WLL 90°-45° [lb]	d [inch]	t [inch]	w [inch]	s [inch]	Weight [lb/pc.]	for 1-leg chain slings	for 2-leg chain slings
AWI10	2,400	0.39	3.15	1.97	0.39	0.31	3/16	3/16
AWI13	3,600	0.51	4.33	2.36	0.39	0.75	9/32	-
AWI16	7,000	0.63	4.33	2.36	0.55	1.17	-	9/32
AWI18	9,300	0.75	5.31	2.95	0.55	2.03	3/8	-
AWI22	15,800	0.91	6.30	3.54	0.67	3.53	1/2	3/8
AWI26	24,200	1.06	7.09	3.94	0.79	5.42	5/8	1/2
AWI32	36,100	1.26	7.87	4.33	1.02	9.13	-	5/8
AWI36	40,000	1.42	10.24	5.51	1.14	13.72	-	-

VWI | Master Link Assembly

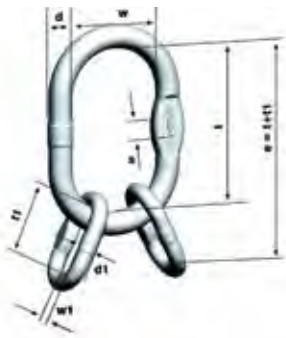

Code	Consisting of	WLL 90°-45° [lb]	e [inch]	d [inch]	t [inch]	w [inch]	d1 [inch]	t1 [inch]	w1 [inch]	Weight [lb/pc.]
VWI5	AWI13 + 2 BW110*	3,600	9.65	0.75	5.31	2.95	0.51	4.33	2.36	3.52
VWI7	AWI22 + 2 BW116*	7,000	9.65	0.75	5.31	2.95	0.63	4.33	2.36	4.36
VWI10	AWI26 + 2 BW120*	14,300	13.39	1.06	7.09	3.94	0.91	6.30	3.54	12.45
VWI13	AWI32 + 2 BW122*	24,200	14.96	1.30	7.87	4.33	1.06	7.09	3.94	19.93
VWI16	AWI36 + 2 BW126*	36,100	18.11	1.42	10.24	5.51	1.30	7.87	4.33	31.90

*BW1 dimension on next page

BWI | Secondary Link Dimensions

For dimensional purpose only - Not sold Separately

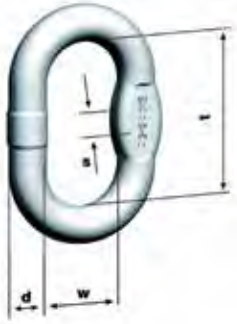

Code	d [inch]	t [inch]	w [inch]	s [inch]
BWI10	0.39	1.73	0.79	-
BWI16	0.63	2.76	1.34	0.55
BWI20	0.79	3.35	1.57	0.63
BWI22	0.91	4.53	1.97	0.67
BWI26	1.06	5.51	2.56	0.79

VLWI | Adjustable



Code	WLL [lb]	e [inch]	e1 [inch]	a [inch]	d [inch]	d1 [inch]	g [inch]	Weight [lb/pc.]
VLWI5	2,000	3.15	4.49	2.05	0.63	1.02	0.31	0.48
VLWI7	3,500	4.37	6.14	2.68	0.87	1.34	0.43	1.25
VLWI10	5,500	5.24	7.20	3.39	1.06	1.57	0.47	2.33
VLWI13	9,300	6.65	9.53	4.25	1.26	2.05	0.63	4.84
VLWI16	13,900	8.03	11.18	5.28	1.50	2.52	0.79	9.15

Latch Kit for HSWI Stainless Steel Eye Sling Hook

Stainless steel safety latch set with extra strong spring and rivetable safety pin

Sold as a kit only	Code	Part #	For Hook
	87017	SFGWI5	3/16"-7/16" Stainles Steel Eye Sling Hook
	87018	SFGWI7	9/32" Stainles Steel Eye Sling Hook
	87019	SFGWI10	3/8" Stainles Steel Eye Sling Hook
	87020	SFGWI13	1/2" Stainles Steel Eye Sling Hook
	87021	SFGWI16	5/8" Stainles Steel Eye Sling Hook

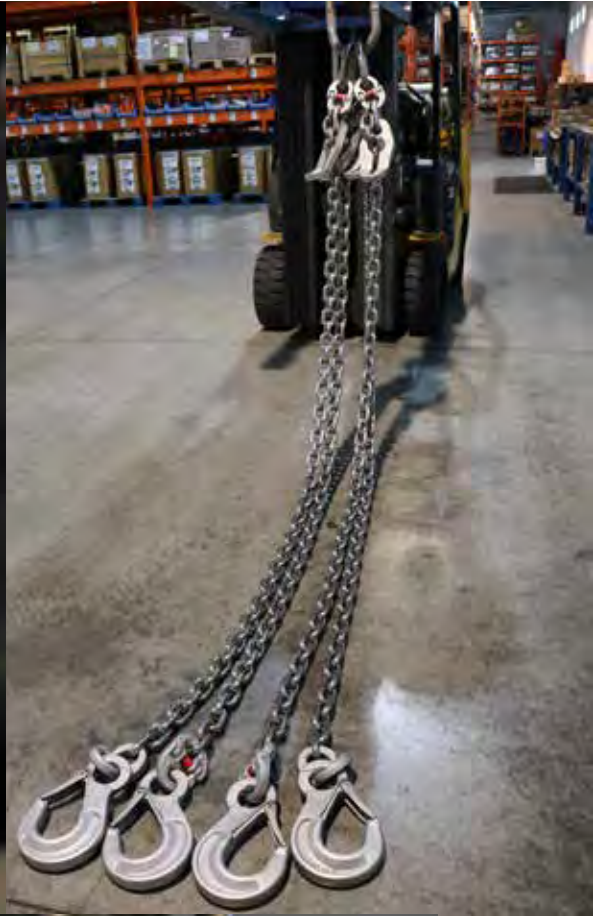



pewag Winner Profilift

Lifting Pionts



PLAW | Pewag Winner Profilift Alpha

The PLAW can be rotated a full 360°. The load ring has a loadable range of 130° (Picture 1). The ring can be positioned at the required angle due to its replaceable and patented spring. The pewag winner profilift alpha is designed with a 4-fold Safety factor.

Each lifting point is marked with an individual serial number that allows product traceability. Pewag winner profilift alpha is available with metric or UNC-thread. The table with the working load limits is a part of the user manual packaged with each lifting point.

The hexagon-special screw is made from grade 10.9 material. The screw is secured against loss and is replaceable. The screw is 100% crack detection tested, covered with a chromate VI-free to protect against corrosion, and marked with the load capacity and thread size.

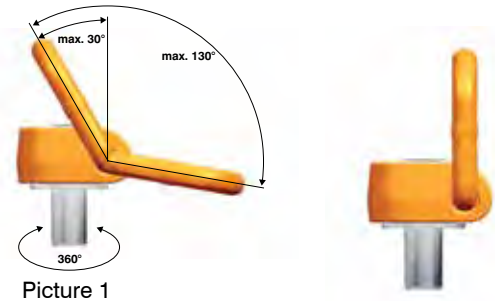

Picture 1

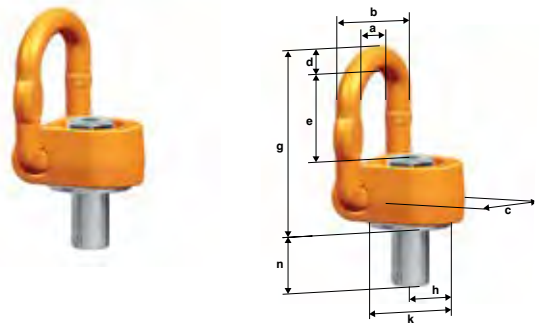

Code	Thread [inch]	WLL [lb]	a [inch]	b [inch]	c [inch]	d [inch]	e [inch]	g [inch]	h [inch]	k [inch]	n [inch]	n max.	Weight [lbs/ea]	
PLAW-3/8	3/8" - 16	1,350	1.77	2.64	1.57	0.43	1.61	3.74	0.91	2.17	0.79	3/8"	1"	1.39
PLAW-1/2	1/2" - 13	2,200	1.77	2.64	1.57	0.43	1.61	3.74	0.91	2.17	1.30	3/8"	1"	1.41
PLAW-5/8	5/8" - 11	3,300	1.77	2.64	1.57	0.43	1.61	3.74	0.91	2.17	1.30	3/8"	1"	1.45
PLAW-3/4	3/4" - 10	4,400	2.13	3.19	1.97	0.51	2.17	4.41	1.34	2.64	1.30	3/8"	1"	2.36
PLAW-1	1" - 8	8,800	2.95	4.53	2.64	0.79	2.68	5.63	1.77	3.94	1.41	9/16"	1 3/8"	6.40
PLAW-1 1/4	1 1/4" - 7	13,200	2.95	4.53	2.64	0.79	2.68	5.63	1.77	3.94	1.93	9/16"	1 3/8"	6.80
PLAW-1 1/2	1 1/2" - 6	17,000	3.66	5.79	3.35	1.06	3.43	7.40	2.05	4.72	2.16	3/4"	1 1/2"	14.40

Method of lifting											
Number of legs		1	1	2	2	2	2	3+4	3+4	2	
Angle of inclination		0°	90°	0°	90°	0°-45°	45°-60°	0°-45°	45°-60°	asymm.	
Code	Thread [inch]	Torque [ft.lb]	WLL [lbs]								
PLAW-3/8	3/8" - 16	51.6	1,350	1,350	2,700	2,700	1,800	1,350	2,800	1,900	1,350
PLAW-1/2	1/2" - 13	88.5	2,200	2,200	4,400	4,400	3,000	2,200	4,600	3,300	2,200
PLAW-5/8	5/8" - 11	148	3,300	3,300	6,600	6,600	4,600	3,300	6,800	4,800	3,300
PLAW-3/4	3/4" - 10	221	4,400	4,400	8,800	8,800	6,000	4,400	9,200	6,500	4,400
PLAW-1	1" - 8	295	8,800	8,800	17,600	17,600	12,300	8,800	18,400	13,200	8,800
PLAW-1 1/4	1 1/4" - 7	369	13,200	13,200	26,400	26,400	18,700	13,200	27,800	19,800	13,200
PLAW-1 1/2	1 1/2" - 6	590	17,000	17,000	34,000	34,000	24,000	17,000	36,000	25,500	17,000
PLAW-1 3/4	1 3/4" - 5	1100	22,000	22,000	44,000	44,000	30,000	22,000	45,000	33,000	22,000

Permissible usage:

- Only use within permissible areas of pull (picture 1)
- Follow appropriate WLL according to inspection certificate and corresponding angle of inclination

Non permissible usage

Make sure when selecting an assembly that improper load can not arise. e.g.,

- the direction of pull is obstructed
- direction of pull is not in the foreseen area (see picture 2)
- load ring rests against edges or load (picture 3)

The load ring must be placed in the direction of pull before loading. Do not rotate under load. For more details please reference the user manual.

To calculate the necessary thread length (L): $L=H+S+K+X$

H = Material height

S = Thickness of the washer

K = Height of the nut (depending on the thread size of the screw)

X = Excess length of the screw (twofold pitch of the screw)

L max. = n max.

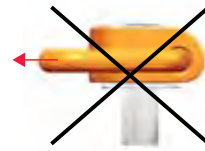

Picture 2

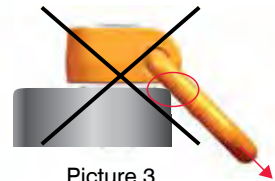

Picture 3

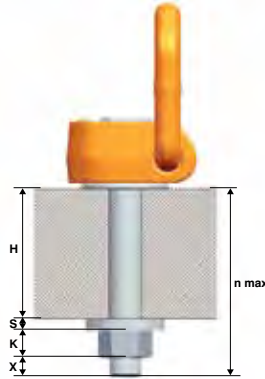

Code	Thread [mm]	WLL [lb]	a [mm]	b [mm]	c [mm]	d [mm]	e [mm]	g [mm]	h [mm]	k [mm]	n [mm]	n max. [mm]		Weight [lbs/ea]	
PLAW-M10	M10	1,350	45	67	40	11	41	95	23	55	29	160	10	24	1.14
PLAW-M12	M12	2,200	45	67	40	11	41	95	23	55	29	160	10	24	1.188
PLAW-M16	M16	3,300	45	67	40	11	41	95	23	55	29	160	10	24	1.21
PLAW-M20	M20	5,500	54	81	50	13	55	112	33	67	33	160	8	24	2.20
PLAW-M24	M24	8,800	75	115	67	20	68	143	45	100	36	220	14	36	5.94
PLAW-M30	M30	13,200	75	115	67	20	68	143	45	100	49	260	14	36	6.16
PLAW-M36	M36	17,000	93	147	85	27	87	188	52	120	55	260	19	36	13.20

Method of lifting



Number of legs

1 1 2 2 2 2 3+4 3+4 2 3+4

Angle of inclination

0° 90° 0° 90° 0°-45° 45°-60° 0°-45° 45°-60° asymm. asymm.

Code	Thread [mm]	Torque [ft.lb]	WLL [lbs]									
PLAW-M10	M10	51.6	1,350	1,350	2,700	2,700	1,800	1,350	2,700	1,900	1,350	1,350
PLAW-M12	M12	88.5	2,200	2,200	4,400	4,400	3,000	2,200	4,400	3,300	2,200	2,200
PLAW-M16	M16	147.5	3,300	3,300	6,600	6,600	4,600	3,300	6,600	4,800	3,300	3,300
PLAW-M20	M20	221.3	5,500	5,500	11,000	11,000	7,700	5,500	11,000	8,200	5,500	5,500
PLAW-M24	M24	295.0	8,800	8,800	17,600	17,600	12,320	8,800	17,600	13,200	8,800	8,800
PLAW-M30	M30	368.8	13,200	13,200	26,400	26,400	18,700	13,200	26,400	19,000	13,200	13,200
PLAW-M36	M36	590.0	17,000	17,000	34,000	34,000	24,000	17,000	34,000	25,500	17,000	17,000

PLGW | pewag winner profilift gamma

pewag introduces a worldwide innovation to the market. We have designed and manufactured a patented and unique lifting point for the tool-free anchorage. The PLGW can be rotated a full 360°, easily tightened without any tools, and aligned in the load direction manually.

Each lifting point is marked with an individual serial number. pewag winner profilift gamma is available with metric or UNC-thread. The table with the working load limits is a part of the user manual packaged with each lifting point.

The hexagon-special screw is made from grade 10.9 material, is secured against loss and is replaceable. The screw is 100% crack-tested and covered with a chromate VI-free finish to protect against corrosion, and is marked with the WLL and thread size.

Tool-free assembly and disassembly

The valve in position 1 must not have any contact with the screw (picture 1)

- The valve is kept in position with a patented spring
- Lifting Point is rotatable

The valve in position 2 has contact with the screw (picture 2)

- The valve is kept in position with a patented spring
- Lifting Point is not rotatable. The fastening torque is transmitted to the screw and thus the eye bolt can be (re)assembled.



Picture 1

Picture 2

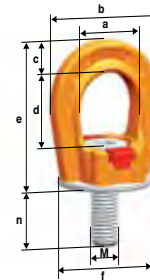

Code	Thread [inch]	Load capacity [lbs]	a [inch]	b [inch]	c [inch]	d [inche]	e [inch]	Ø f [inch]	n [inch]	m [inch]	Weight [lbs/ea.]
PLGW 0.5 T	3/8"-16	2,400	0.98	1.77	0.39	1.04	2.09	1.38	0.60	1/4"	0.40
PLGW 0.7 T	1/2"-13	4,400	1.18	2.17	0.47	1.26	2.48	1.69	0.80	5/16"	0.64
PLGW 1.5 T	5/8"-11	8,800	1.38	2.52	0.55	1.40	2.76	1.97	1.00	3/8"	0.99
PLGW 2T	3/4"-10	9,900	1.57	2.72	0.63	1.59	3.07	2.13	1.20	1/2"	1.28
PLGW 3 T	1" - 8	11,000	1.97	3.39	0.71	1.97	3.82	2.72	1.40	9/16"	2.43
PLGW 4 T	1-1/4" -7	22,000	2.36	4.33	0.98	2.36	4.49	3.54	1.80	5/8"	4.85
PLGW 7T	1-1/2" -6	33,000	2.76	5.20	1.22	2.76	5.35	4.25	2.2	7/8"	8.60

Method of lifting
Number of legs
Angle of inclination

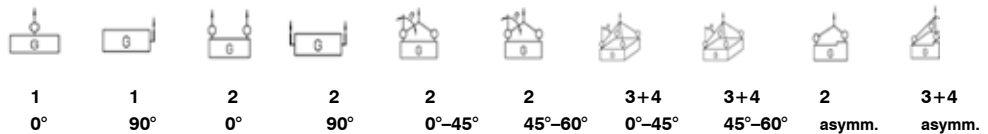

Code	Thread [Inch]	Fastening torque [lbs]	Load capacity [lbs]									
PLGW 0.5 T	3/8"-16	Can be tightened manually	2,400	1,100	4,800	2,200	1,500	1,100	2,200	1,500	1,100	1,100
PLGW 0.7 T	1/2"-13		4,400	1,500	8,800	3,000	2,200	1,500	3,000	2,200	1,500	1,500
PLGW 1.5 T	5/8"-11		8,800	3,300	17,600	6,600	4,600	3,300	6,600	4,800	3,300	3,300
PLGW 2T	3/4"-10		9,900	4,400	19,800	8,800	6,100	4,400	9,200	6,600	4,400	4,400
PLGW 3 T	1" - 8		11,000	6,600	22,000	13,200	9,200	6,600	13,600	9,900	6,600	6,600
PLGW 4 T	1-1/4" -7		22,000	8,800	44,000	17,600	12,300	8,800	18,000	13,200	8,800	8,800
PLGW 7T	1-1/2" -6		33,000	15,400	66,000	30,800	21,500	15,400	32,300	23,100	15,400	15,400

Safety factor 4
Attention: Subject to technical changes!

Permissible usage

- Only use within mentioned areas of pull (picture 3)
- Follow appropriate WLL according to inspection certificated and corresponding angle of inclination

Non permissible usage

Make sure when choosing the assembly that improper load can not arise. e.g.,

- the direction of pull is obstructed
- direction of pull is not in the foreseen area (see picture 4)



Picture 3



Picture 4

To calculate the necessary thread length (L): $L = H + S + K + X$

H = Material height

S = Thickness of the washer

K = Height of the nut (depending on the thread size of the screw)

X = Excess length of the screw (twofold pitch of the screw)

Code	Thread [mm]	Load capacity [kg]	a [mm]	b [mm]	c [mm]	d [mm]	e [mm]	Ø f [mm]	n [mm]	m [mm]	Weight [kg/ea.]
PLGW 0.4 T	M8	400	25	45	9	26,5	53	35	15	6	0,22
PLGW 0.5 T	M10	500	25	45	9	26,5	53	35	15	6	0,24
PLGW 0.7 T	M12	700	30	55	11	32	63	43	20	8	0,29
PLGW 1.5 T	M16	1.500	35	64	13	35,5	70	50	25	10	0,45
PLGW 2 T	M20	2.000	40	69	15	40,5	78	54	30	12	0,58
PLGW 3 T	M24	3.000	50	86	17	50	93	69	35	14	1,10
PLGW 4 T	M30	4.000	60	110	23	60	114	90	45	17	2,10
PLGW 7 T	M36	7.000	70	132	31	70	136	108	55	19	3,90
PLGW 9 T	M42	9.000	80	150	32	80	155	125	65	22	5,95
PLGW 12 T	M48	12.000	95	179	42	95	179	148	75	24	8,90

Attention: Subject to technical changes!

Availability on request!

Method of lifting

Number of legs

Angle of inclination

1	1	2	2	2	2	3+4	3+4	2	3+4
0°	90°	0°	90°	0°-45°	45°-60°	0°-45°	45°-60°	asymm.	asymm.

Code	Thread [mm]	Fastening torque [Nm]	Load capacity [kg]									
PLGW 0.4 T	M8	Can be tightened manually	800	300	1,600	600	400	300	600	400	300	300
PLGW 0.5 T	M10		1,100	500	2,200	1.000	700	500	1,000	700	500	500
PLGW 0.7 T	M12		2,000	700	4,000	1.400	1,000	700	1,400	1,000	700	700
PLGW 1.5 T	M16		4,000	1,500	8,000	3.000	2,100	1,500	3,000	2,200	1,500	1,500
PLGW 2 T	M20		5,000	2,000	10,000	4.000	2,800	2,000	4,200	3,000	2,000	2,000
PLGW 3 T	M24		7,000	3,000	14,000	6.000	4,200	3,000	6,200	4,500	3,000	3,000
PLGW 4 T	M30		10,000	4,000	20,000	8.000	5,600	4,000	8,200	6,000	4,000	4,000
PLGW 7 T	M36		15,000	7,000	30,000	14.000	9,800	7,000	14,700	10,500	7,000	7,000
PLGW 9 T	M42		22,000	9,000	44,000	18.000	12,600	9,000	18,900	13,500	9,000	9,000
PLGW 12 T	M48		30,000	12,000	60,000	24.000	16,800	12,000	25,000	18,000	12,000	12,000

Safety factor 4

Attention: Subject to technical changes!

PLBW | Pewag Winner Profilift Beta

The PLBW can rotated a full 360°. The load ring has a 180° adjustable range, and can be positioned at the desired angle due to its replaceable and patented spring (picture 2). The PLBW has been designed for 5-fold safety within the permissible field of operations.

Each lifting point is marked with an individual serial number. The PLBW is available with metric or UNC-thread. The table with the working load limits is a part of the user manual packaged with each lifting point.

The hexagon-special screw is made from grade 10.9 material, is secured against loss, and is also replaceable. The screw is 100% crack-tested, covered with a chromate VI-free finish to protect against corrosion, and marked with WLL and thread size. The screw can be tightened with a hexagon wrench or a spanner wrench.

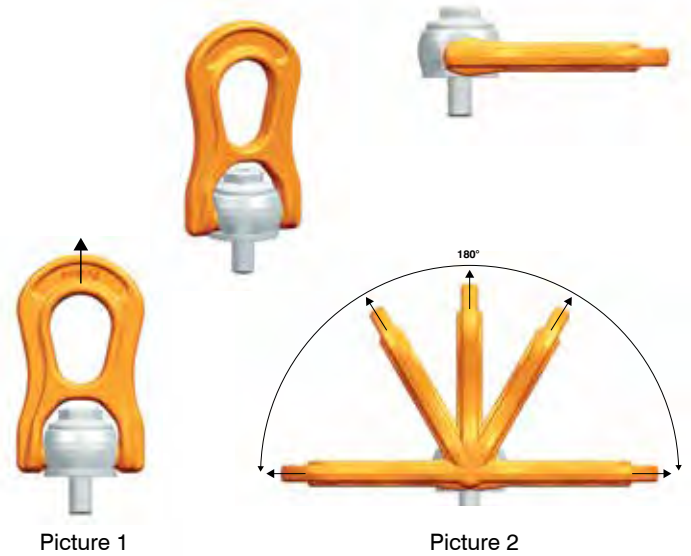

Code	Thread [inch]	WLL [lbs]	a [inch]	b [inch]	c [inch]	e [inch]	f [inch]	g [inch]	h [inch]	n [inch]	n max [inch]	Weight [lb/pc.]	
PLBW-3/8	3/8" - 16	1,300	1.14	2.20	1.18	1.50	0.71	1.06	3.70	0.59	5/16"	5/8"	0.73
PLBW-7/16	7/16" - 14	2,200	1.14	2.20	1.18	1.50	0.71	1.06	3.70	0.67	5/16"	5/8"	0.75
PLBW-9/16	9/16" - 12	3,000	1.69	3.11	1.77	2.17	0.98	1.50	5.43	0.87	5/16"	1"	2.27
PLBW-5/8	5/8" - 11	3,500	1.69	3.11	1.77	2.17	0.98	1.50	5.43	0.95	5/16"	1"	2.29
PLBW-3/4	3/4" - 10	5,500	1.69	3.11	1.77	2.17	0.98	1.50	5.43	1.19	5/16"	1"	2.38
PLBW-7/8	7/8" - 9	8,800	2.52	4.65	2.68	3.35	1.50	2.28	8.23	1.44	9/16"	1 3/8"	7.78
PLBW-1	1" - 8	11,000	2.52	4.65	2.68	3.35	1.50	2.28	8.23	1.59	9/16"	1 3/8"	7.89
PLBW-1/8	1 1/8" - 7	13,500	2.52	4.65	2.68	3.35	1.50	2.28	8.23	1.79	9/16"	1 3/8"	8.07
PLBW-1 1/4	1 1/4" - 7	17,500	4.17	7.40	4.25	5.20	2.36	3.58	13.03	2.13	3/4"	2 3/16"	32.0
PLBW-1 3/8	1 3/8" - 6	22,000	4.17	7.40	4.25	5.20	2.36	3.58	13.03	2.32	3/4"	2 3/16"	32.2
PLBW-1 1/2	1 1/2" - 6	24,000	4.17	7.40	4.25	5.20	2.36	3.58	13.03	2.72	3/4"	2 3/16"	32.8

Method of lifting



Number of legs	1	1	2	2	2	2	3 + 4	3 + 4	2	3 + 4
Angle of inclination	0°	90°	0°	90°	0°-45°	45°-60°	0°-45°	45°-60°	asymm.	asymm.

Code	Thread [inch]	Torque [ft/lb]	WLL [lbs]									
PLBW-3/8	3/8"-16	7.5	2,200	1,300	4,400	2,600	1,800	1,300	2,700	1,300	1,300	1,300
PLBW-7/16	7/16"-14	11	2,800	2,200	5,600	4,400	3,000	2,200	4,600	2,200	2,200	2,200
PLBW-9/16	9/16"-12	22	4,400	3,000	8,800	6,000	4,200	3,000	6,300	3,000	3,000	3,000
PLBW-5/8	5/8"-11	37	5,500	3,500	11,000	7,000	4,900	3,500	7,300	3,500	3,500	3,500
PLBW-3/4	3/4"-10	74	6,600	5,500	13,200	11,000	7,700	5,500	11,500	5,500	5,500	5,500
PLBW-7/8	7/8"-9	118	12,000	8,800	24,000	17,600	12,300	8,800	18,500	8,800	8,800	8,800
PLBW-1	1"-8	148	13,000	11,000	26,000	22,000	15,400	11,000	23,000	11,000	11,000	11,000
PLBW-1/8	1 1/8"-7	185	14,300	13,500	28,600	27,000	18,900	13,500	28,300	13,500	13,500	13,500
PLBW-1 1/4	1 1/4"-7	200	19,800	17,500	39,600	35,000	24,500	17,500	36,700	17,500	17,500	17,500
PLBW-1 3/8	1 3/8"-6	236	24,000	22,000	48,000	44,000	30,800	22,000	46,200	22,000	22,000	22,000
PLBW-1 1/2	1 1/2"-6	295	25,000	24,000	50,000	48,000	33,600	24,000	50,400	24,000	24,000	24,000

Permissible usage

- Only use within permissible areas of pull (pictures 1 & 2)
- Follow appropriate WLL according to the inspection certificate and corresponding angle of inclination

Non permissible usage

Make sure when choosing the assembly that improper load can not arise. e.g.,

- the direction of pull is obstructed
- direction of pull is not in the foreseen area (see picture 3)
- loading ring rests against edges or load (picture 4)

The load ring must be placed in the direction of pull before loading. Do not rotate under load. For more details please have a look into our user manual.

To calculate the necessary thread length (L): $L = H + S + K + X$

H = Material height

S = Thickness of the washer

K = Height of the nut (depending on the thread size of the screw)

X = Excess length of the screw (twofold pitch of the screw)



Picture 3

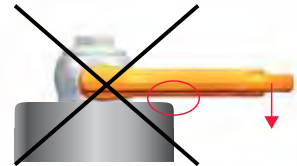

Picture 4

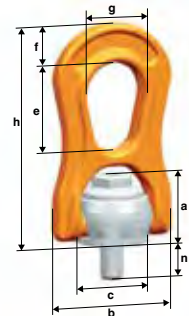
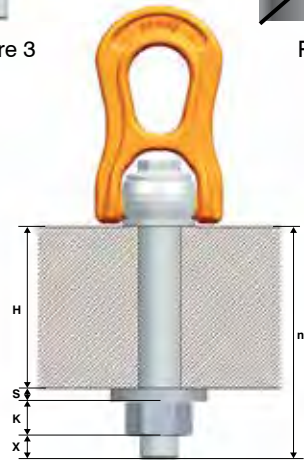

Code	Thread [mm]	WLL [lb]	a [mm]	b [mm]	c [mm]	d [mm]	e [mm]	g [mm]	h [mm]	k [mm]	n [mm]	n max. [mm]	Weight [lb/pc.]
PLBW-M10	M10	1,350	45	67	40	11	41	95	23	55	29	160	1.14
PLBW-M12	M12	2,200	45	67	40	11	41	95	23	55	29	160	1.188
PLBW-M16	M16	3,300	45	67	40	11	41	95	23	55	29	160	1.21
PLBW-M20	M20	5,500	54	81	50	13	55	112	33	67	33	160	2.20
PLBW-M24	M24	8,800	75	115	67	20	68	143	45	100	36	220	5.94
PLBW-M30	M30	13,200	75	115	67	20	68	143	45	100	49	260	6.16
PLBW-M36	M36	17,000	93	147	85	27	87	188	52	120	55	260	13.20

Method of lifting												
Number of legs	1	1	2	2	2	2	3+4	3+4	2	3+4		
Angle of inclination	0°	90°	0°	90°	0°-45°	45°-60°	0°-45°	45°-60°	asymm.	asymm.		

Code	Thread [mm]	Torque [ft/lb]	WLL [lbs]									
PLBW-M10	M10	51.6	1,350	1,350	2,700	2,700	1,800	1,350	2,700	1,900	1,350	1,350
PLBW-M12	M12	88.5	2,200	2,200	4,400	4,400	3,000	2,200	4,400	3,300	2,200	2,200
PLBW-M16	M16	147.5	3,300	3,300	6,600	6,600	4,600	3,300	6,600	4,800	3,300	3,300
PLBW-M20	M20	221.3	5,500	5,500	11,000	11,000	7,700	5,500	11,000	8,200	5,500	5,500
PLBW-M24	M24	295.0	8,800	8,800	17,600	17,600	12,320	8,800	17,600	13,200	8,800	8,800
PLBW-M30	M30	368.8	13,200	13,200	26,400	26,400	18,700	13,200	26,400	19,000	13,200	13,200
PLBW-M36	M36	590.0	17,000	17,000	34,000	34,000	24,000	17,000	34,000	25,500	17,000	17,000

PLE | Pewag Winner Profilift Eta

The pewag winner profilift eta, for welding onto machine parts or vehicle bodies. This high quality lifting point is ideal for hanging of lifting and lashing parts. Due to the integrated spring, the ring will be kept in each requested position. The instructions according to EN 15817 are valid for the welding.

The PLE is manufactured according to EG-Machine Directive 2006/42/EG and tested according to EN 1677-1. The WLL is clearly marked on the welding pad.

Welding may only be carried out by a welding operator with valid qualifications according to EN 287-1. Each lifting point will be packaged individually, and with the user manual and welding instructions.

Permissible usage

Load capacity acc. to the inspection certificate respectively table of WLL in the mentioned directions of pull – see picture 1 and 2.

Non permissible usage

Make sure when choosing the assembly that improper load can not arise. e.g.,

- the direction of pull is obstructed
- direction of pull is not in the foreseen area (see picture 3)
- loading ring rests against edges and load

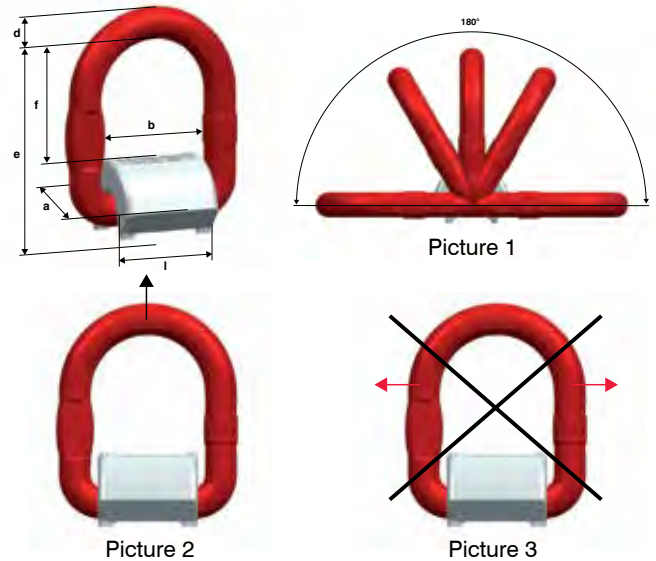

Code	WLL [lbs]	a [inch]	b [inch]	d [inch]	e [inch]	f [inch]	l [inch]	Weight [lb/pc.]
PLE 6	2464	1.42	1.50	0.43	2.64	1.57	1.38	0.62
PLE 8	4400	1.46	1.57	0.51	2.87	1.69	1.46	0.86
PLE 10	6930	1.61	1.69	0.65	3.27	1.85	1.57	1.36
PLE 13	11660	2.24	2.05	0.77	3.82	2.13	1.97	2.64
PLE 16	17600	2.48	2.64	0.91	4.72	2.87	2.52	4.40
PLE 22	33000	3.50	3.66	1.30	6.42	3.62	3.54	12.10

Method of lifting



Number of legs	1	1	2	2	2	2	3 + 4	3 + 4	2	3 + 4
Angle of inclination	0°	90°	0°	90°	0°-45°	45°-60°	0°-45°	45°-60°	asymm.	asymm.

Code	WLL [lbs]									
PLE6	2,464	2,464	4,928	4,928	3,300	2,464	5,060	3,520	2,464	2,464
PLE8	4,400	4,400	8,800	8,800	6,160	4,400	9,240	6,600	4,400	4,400
PLE10	6,930	6,930	13,860	13,860	9,680	6,930	14,520	10,340	6,930	6,930
PLE13	11,660	11,660	23,320	23,320	16,280	11,660	24,640	17,380	11,660	11,660
PLE16	17,600	17,600	35,200	35,200	24,860	17,600	37,180	26,400	17,600	17,600
PLE22	33,000	33,000	66,000	66,000	46,200	33,000	69,960	49,500	33,000	33,000





Other Chains

Chain and Accessories



Stainless Steel Chain

316 L will resist pitting and most kinds of corrosion. Chain has excellent resistance to pitting in phosphoric and acetic solution.



! NOT FOR OVERHEAD LIFTING !

Type	Trade size		Actual Material Dia. In	Norm/Inside Link Size Wd. In.	Norm/Inside Link Size Lg. In.	WLL lb	Weight lb/ft.
	In.	mm					
316 L	5/64"	2	0.079	0.14	0.87	55	0.04
	7/64"	3	0.118	0.21	1.02	132	0.10
	1/8"	4	0.158	0.26	0.94	410	0.19
	3/16"	5	0.200	0.38	0.95	1200	0.32
	9/32"	7	0.276	0.43	0.87	2000	0.73
	5/16"	8	0.315	0.46	0.94	2850	0.96
	3/8"	10	0.393	0.55	1.10	3550	1.53
	1/2"	13	0.512	0.69	1.54	7400	2.49

304 L has good resistance to atmospheric corrosion.



! NOT FOR OVERHEAD LIFTING !

304 L	1/8"	4	0.158	0.26	0.94	410	0.19
	3/16"	5	0.200	0.38	0.95	1200	0.32
	9/32"	7	0.276	0.45	0.86	2000	0.73
	5/16"	8	0.315	0.46	0.94	2450	0.96
	3/8"	10	0.393	0.55	1.10	3550	1.53

Alloy Steel Hoist Chains

Pewag to OEM Crossover Chart

Hoist Brand	Pewag chain #	OEM' Chain #	Chain Description
Lodestar (CM)	19790	85944	G-80 RDS Z/P
Lodestar (CM)	19801	85949	G-80 RDS Z/P
Coffing EC/ELC	2380	JL-19-B	G-80 RD
Coffing EC/ELC	20577	JL-19-1	G-80 RD
Budgit	19790	910126 Z/P 208776-3	G-80 RD Z/P
Budgit	19801	910142 Z/P 209156-3	G-80 RD Z/P
CM (Manual)	63273	85839	G-80 HEO S/C
CM (Manual)	63274	85847	G-80 HEO S/C
Harrington (electric)	64403	LCER010C	G-80 HE RDS S/C
Harrington	32060	KLB5056NP/LCL5010NP	G-100 HEO S/C
Harrington	32072	KLB5071NP/LCL5015NP	G-100 HEO S/C
Harrington	32073	KLB5100NO/LCL5030NP	G-100 HEO S/C

All Square Casehardened Security Chain

All Square Casehardened Security Chain

Chain Diameter		Inch	Stock Number.	Standard Package	Weight 100 ft.	Finish
In.	mm					
9/32	7	0.276	14827	100'	75	EG
3/8	10	0.394	11696	100'	165	EG
1/2	12	0.473	56847	500'	239	EG



WARNING
 NOT FOR OVERHEAD LIFTING !

Security Padlocks for Security Chain

For Chain Diameter		Stock Number.	Description
In.	mm		
9/32	7	4228	Viro Panzer Lock for 9/32 (7mm) Security Chain
3/8	10	4126	Viro Panzer Lock for 3/8" (10mm) Security Chain
3/8	10	4126/KA	Viro Panzer Lock for 3/8" (10mm) Security Chain Keyed Alike
1/2	12	4153	Viro Monolith Lock for 1/2" (12mm) Security Chain



4228



4126



4153

Investing in America

Thanks to the continued support from all of our North American customers, pewag officially opened it's first North American manufacturing plant in Pueblo, Colorado.

Beginning In 2014, pewag will be the first European chain manufacturer to produce chain in the USA, bringing over 500 years of manufacturing experience to America!





Thank you for your business!
Your pewag Team USA