

# GrabiQ

by Gunnebo Lifting

ADVANCED CHAIN & SLING SYSTEMS



A new level of versatility in rigging that provides true strength.

**WESTECH RIGGING SUPPLY**

Call Toll Free: 800-442-7475

Call Us or Visit Our Stores:  
Monday - Friday, 8:00am - 5:30pm Pacific



Distributed By

Visit Us Online at: [www.WestechRigging.com](http://www.WestechRigging.com)

4140 West 11th Avenue  
Eugene, Oregon 97402

2439 McGilchrist St SE  
Salem, Oregon 97302

**GUNNEBO JOHNSON**  
CORPORATION

### A TOTALLY NEW WAY TO FABRICATE CHAIN SLINGS



Fig. 1. The GrabiQ Master Grab combines a master link, master link connectors for two legs of chain, and two shortening hooks into a single fitting. The shortening hook can also be used to create loop legs.

GrabiQ is an exciting new family of alloy chain sling components. Instead of the old “one component does one job” fitting, GrabiQ combines in a single component up to three separate functions. Figure 1 features a GrabiQ Master Grab, which serves as the master link, connecting link for two legs of chain, and shortening hooks for each leg, all in one fitting. Using traditional fittings to construct the same sling (figure 2) would require



Fig. 2. Traditional two leg; fully adjustable sling would require 7 components.

7 top-of-the-sling components, instead of just one. Some of the new GrabiQ fittings are equally well suited for use as top assembly connectors or hooks at the bottom of a sling, adding even more flexibility for riggers.

*GrabiQ is much more versatile and flexible than other chain slings. Each leg of a GrabiQ sling is typically furnished with a chain pocket, which can be used for shortening or creating leg loops. Rigging has never been easier.*

While the specific Working Load Limits vary, depending on size, slings fabricated from grade 100 chain and fittings are about 25% stronger than their grade 80 counterparts. Converting from grade 80 to GrabiQ will especially benefit users who can make use of the

additional WLL without the expense of purchasing larger chain and fittings.

The percentage of strength increase varies depending on the size. The Working Load Limit (WLL) gain for 3/8” is about 24 percent, while the WLL gain for 7/32” is more than 30 percent. All other sizes fall somewhere in between.

### FEWER COMPONENTS MEANS LESS WEIGHT

Most of the time, GrabiQ slings will be lighter than their grade 80 counterparts. *Fewer components means less weight.* Also, because grade 100 has a lifting capacity that is usually 25% higher than its grade 80 counterpart, the ratio of strength-to-weight is greater, offering additional weight savings with GrabiQ.

### A TRUE GRADE 100 ALLOY CHAIN SLING



Fig. 3. Each GrabiQ component is clearly marked with the number 10, designating it as Grade 100.



Fig. 4. Only 3 top-of-the-sling GrabiQ components are needed to fabricate a 4-leg, fully adjustable sling.



Fig. 5. Traditional fabrication requires 15 fittings

## REDUCED COMPONENTS MEANS LESS CLUTTER

Because GrabiQ often reduces the number of components required to assemble a chain sling, rigging is easier. Figure 7 shows a three-leg fully adjustable chain sling with all three legs shortened. The sling still has only three fittings at the top.



Fig. 7. "A three-leg, fully adjustable sling."

## MORE FLEXIBILITY IN CHAIN SLING USES

When each GrabiQ leg is furnished with a chain pocket, the chain sling can be used for a much wider variety of loads, often reducing the amount of rigging required on site. The chain pocket can be used to either shorten a leg or create a leg loop. Some fittings are equally well suited for use at the top or bottom of a chain sling. For example, the GrabiQ C-Grab can be used as a top-of-the-sling connector or as pictured in figure 8, at the bottom of the sling as an adjustable sliding choker.

## CHAIN SLING INSPECTIONS ARE EASIER

Inspecting chain slings is easier and faster because fewer components must be examined for wear or damage.

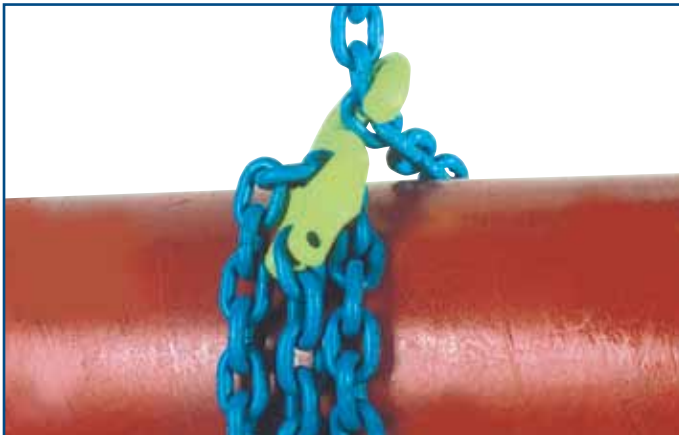

Fig. 8. "A GrabiQ C-Grab used at the bottom of the sling as an adjustable sliding choker."

## I N D E X

<b>COMPONENTS</b> .....	<b>4 - 10</b>
<b>TOP ASSEMBLIES</b> .....	<b>11</b>
<b>TOP GRABS</b> .....	<b>12</b>
<b>BASKETS</b> .....	<b>13 - 14</b>
<b>SPARE PARTS</b> .....	<b>15 - 17</b>
<b>SLINGS</b> .....	<b>18 - 22</b>
<b>TIPS FOR GRABIQ SLING ASSEMBLY</b> . . .	<b>23</b>
<b>WARNING AND USE LIMITATIONS</b> . .	<b>24 - 29</b>

## QUALITY STANDARDS:

Grade 100 GrabiQ alloy steel chain and chain sling components are manufactured and tested in accordance with ASTM A973, A952, and A907 material standards. GrabiQ chain and components meet or exceed the safety standards as prescribed by ASME B30.9 & B30.10, and OSHA alloy steel chain sling regulations.

All chain and every single component is proof-loaded to 2.5 times the Working Load Limit.

The Swedish plants manufacturing GrabiQ products are certified to ISO 9001/ ISO 9002 Quality Standards. Gunnebo Lifting's quality management covers all aspects of production from raw material to delivered product.

Full Test Certification is supplied on request.

## ADDING STRENGTH

### 25% Stronger

With the introduction of the new grade 100, we add as much as 25% extra strength over grade 80. We have greatly increased the Working Load Limits of slings, yet with the same design factor as grade 80.

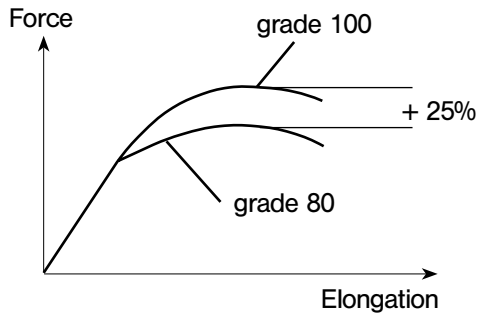

### GrabiQ ...Quality assurance

1. Ultimate force test
2. Proof Force Test
3. Total Ultimate Elongation
4. Dynamic fatigue tests
5. Traceability

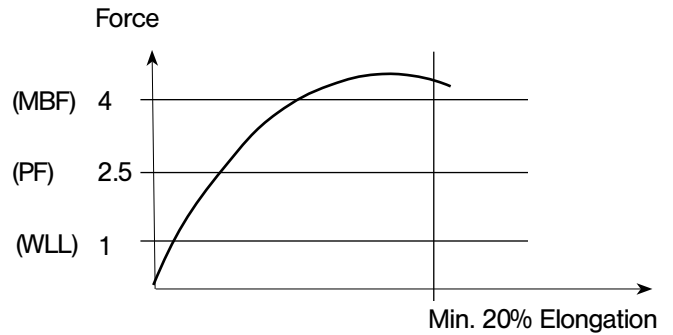
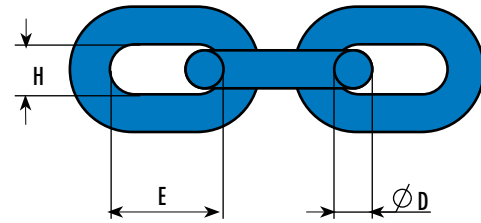

WLL = Working Load Limit  
 PF = Proof Force  
 MBF = Minimum Breaking Force

Chain Size Inches	E (In)	H min (In)	Working Load Limit *(Lbs)	Proof Force (Lbs)	Minimum Breaking Force (Lbs)
5/16"	0.95	0.43	5,700	14,136	22,800
3/8"	1.2	0.53	8,800	21,824	35,200
1/2"	1.5	0.69	15,000	37,200	60,000
5/8"	1.9	0.85	22,600	56,048	90,400





Every link is calibrated & pull tested to 62% of the minimum breaking force.



Minimum of 20% elongation. Fully hardened and tempered alloy steel.

## ALLOY CHAIN

Heat number identification allows full product traceability.



Cradle type integrated chain pockets permit shortening or creating leg loops for each leg with no reduction in working load limit.

## MASTERGRAB MG

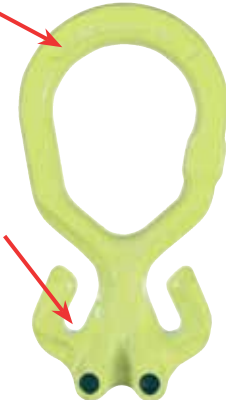

## MASTERGRAB DUAL MGD

### ALLOY CHAIN - GRADE 100

Stock No.	Model	Chain Size Inches	Working Load Limit *(Lbs)	OD	E	H	Weight 100 ft. (Lbs)
590407	KLA-8-10	5/16"	5,700	0.32	0.94	0.45	97
590409	KLA-10-10	3/8"	8,800	0.40	1.2	0.57	151
590411	KLA-13-10	1/2"	15,000	0.52	1.5	0.72	253
590413	KLA-16-10	5/8"	22,600	0.65	1.9	0.91	394

\*Design factor 4

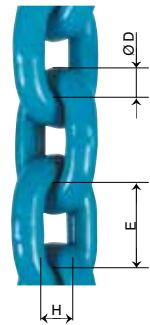

### MASTER GRAB TYPE MG

An all in one fitting, combining master link, connector and shortening function for single leg sling.

Stock No.	Model	Chain Size Inches	Working Load Limit *(Lbs)	L (In)	A	B	H	Weight Each (Lbs)
589406	MG-8-10	5/16"	5,700	6.7	3.6	2.4	0.71	2.0
589407	MG-10-10	3/8"	8,800	8.3	4.4	3.0	0.87	4.0
589408	MG-13-10	1/2"	15,000	10.3	5.4	3.5	1.0	7.7
589409	MG-16-10	5/8"	22,600	12.2	6.2	4.1	1.2	13.4

\*Design factor 4

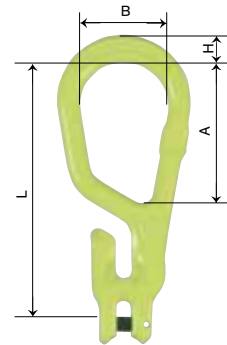

### MASTER GRAB DUAL TYPE MGD

An all in one fitting, combining master link, connector and shortening function for a two leg sling.

Stock No.	Model	Chain Size Inches	Working Load Limit *(Lbs) at 60°	L (In)	A	B	H	Weight Each (Lbs)
589410	MGD-8-10	5/16"	9,900	6.7	3.9	3.0	0.83	2.9
589411	MGD-10-10	3/8"	15,200	8.3	4.9	3.5	0.94	5.1
589412	MGD-13-10	1/2"	26,000	10.3	5.9	4.1	1.2	11.5
589413	MGD-16-10	5/8"	39,100	12.2	6.9	4.7	1.4	17.4

\*Design factor 4

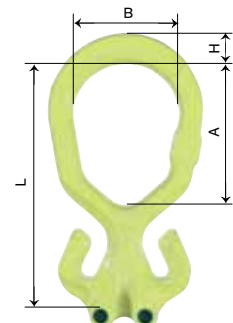

# COMPONENTS

Engineered Flat helps match the master link with the correct GrabiQ connecting links.

Oversized master links designed for use on very large crane hooks.

Heat number identification allows full product traceability.

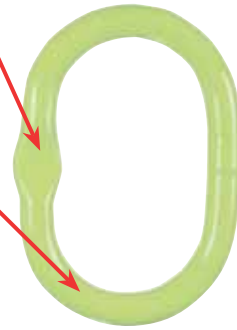
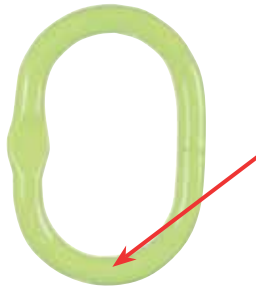

**OBLONG MASTER LINK - MF**

**OVERSIZE MASTER LINK - MFX**

**OVERSIZE MASTER LINK - MFH**

## OBLONG MASTER LINK - MF

For 1, 2, 3, or 4 leg chain slings when used with C-Grab and C-Lok connectors

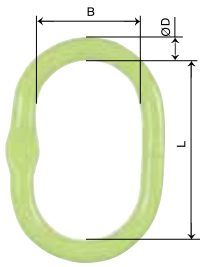

Stock No.	Model	Trade Size Inches	1-Leg 90°	Working Load Limit *(Lbs)	2-Legs 60°	Working Load Limit *(Lbs)	3-4 Legs 60°	Working Load Limit *(Lbs)	L	B	D	Weight Each (Lbs)
589385	MF-86-10	1/2"	5/16"	5,700	-	-	-	-	4.9	2.8	0.55	0.9
589386	MF-108-10	5/8"	3/8"	8,800	5/16"	9,900	-	-	5.5	3.1	0.67	1.8
589387	MF-1310-10	7/8"	1/2"	15,000	3/8"	15,200	5/16"	14,800	6.3	3.7	0.87	3.3
589388	MF-1613-10	1"	5/8"	22,600	1/2"	26,000	3/8"	22,900	7.5	4.3	1.1	4.8
589389	MF-2016-10	1 3/8"	-	-	5/8"	39,100	1/2"	39,000	9.4	5.5	1.3	11.5
589505	MF-2220-10	1 1/2"	-	-	-	-	5/8"	58,700	9.8	5.9	1.6	16.1

\*Design factor 4

## OBLONG MASTER LINK - MFX OVERSIZED FOR LARGE CRANE HOOKS

For 1 or 2 leg chain slings when used with C-Grab and C-Lok connectors

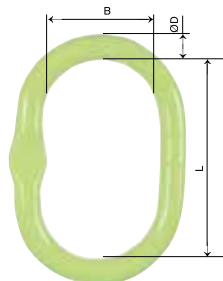

Stock No.	Model	Trade Size Inches	1-Leg 90°	Working Load Limit *(Lbs)	2-Legs 60°	Working Load Limit *(Lbs)	L	B	D	Weight Each (Lbs)
589455	MFX-108-10	1"	5/16"	5,700	-	-	13.4	7.1	1.0	8.2
589455	MFX-108-10	1"	3/8"	8,800	5/16"	9,900	13.4	7.1	1.0	8.2
589456	MFX-1310-10	1 1/8"	1/2"	15,000	3/8"	15,200	13.4	7.1	1.1	10.4
589457	MFX-1613-10	1 3/8"	5/8"	22,600	1/2"	26,000	13.4	7.1	1.3	15.6
590332	MFX-2016-10	1 1/2"	-	-	5/8"	39,100	13.4	7.1	1.5	18.7

\*Design factor 4

## MFH OVERSIZED MASTER LINK DESIGNED FOR USE ON LARGE CRANE HOOKS

For 1, 2, 3, or 4 leg chain slings when used with C-Grab and C-Lok connectors

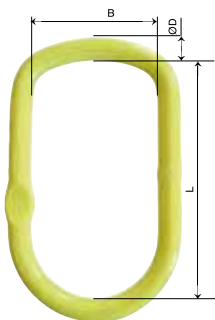

Part Number	Model	Trade Size Inches	1-Leg 90°	Working Load Limit *(lbs.)	2-Leg 60°	Working Load Limit *(lbs.)	3-4 Legs 60°	Working Load Limit *(lbs.)	L	B	D	Weight (Lbs.)
590415	MFH-1310-10	7/8"	5/16"	5,700	-	-	-	-	9.1	4.9	0.9	4.2
590415	MFH-1310-10	7/8"	3/8"	8,800	5/16"	9,900	-	-	9.1	4.9	0.9	4.2
590415	MFH-1310-10	7/8"	1/2"	15,000	3/8"	15,200	5/16"	14,800	9.1	4.9	0.9	4.2
590416	MFH-1613-10	1"	5/8"	22,600	1/2"	26,000	3/8"	22,900	9.8	5.3	1.1	7.1
590417	MFH-2016-10	1 1/4"	-	-	5/8"	39,100	1/2"	39,000	11.0	5.3	1.3	10.1
590418	MFH-2220-10	1 1/2"	-	-	-	-	5/8"	58,700	12.6	6.9	1.6	19.0
590419	MFHW-2220-10	1 1/2"	-	-	-	-	5/8"	58,700	14.0	8.9	1.6	21.8

\* Design Factor 4:1 & Proof Tested To 2 x WLL

NOTE: All MFH master links require fixture for proof testing



SEE WARNINGS AND USE LIMITATIONS ON PAGES 24-29

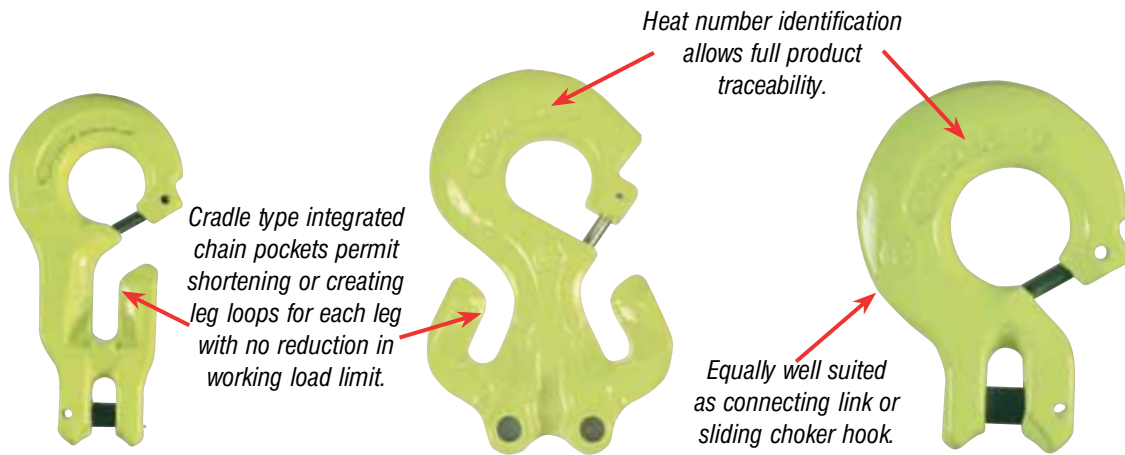

## C-GRAB TYPE CG

## C-GRAB DUAL TYPE CGD

## C-LOK TYPE CL

### C-GRAB TYPE CG

A connecting link used with MF, MFX, or MFH master links to attach one leg of chain. Can also be used as an adjustable sliding choker.

Fitting includes built-in chain pocket for shortening or creating leg loops

Stock No.	Model	Chain Size Inches	Working Load Limit *(Lbs) at 90°	L	B	E	H	Weight Each (Lbs)
589398	CG-8-10	5/16"	5,700	4.2	0.47	1.3	0.9	1.5
589399	CG-10-10	3/8"	8,800	5.3	0.59	1.6	1.1	3.3
589400	CG-13-10	1/2"	15,000	6.8	0.75	2.0	1.5	7.1
589401	CG-16-10	5/8"	22,600	8.5	0.87	2.5	1.9	13.4

\*Design factor 4

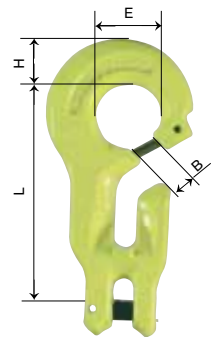

### C-GRAB DUAL TYPE CGD

A connecting link used with MF, MFX, or MFH master links to attach two legs of chain.

Fitting includes built-in chain pockets for shortening or creating leg loops.

Stock No.	Model	Chain Size Inches	Working Load Limit *(Lbs) at 60°	L	B	E	H	Weight Each (Lbs)
589402	CGD-8-10	5/16"	9,900	4.2	0.47	1.3	1.1	2.4
589403	CGD-10-10	3/8"	15,200	5.3	0.59	1.6	1.5	4.8
589404	CGD-13-10	1/2"	26,000	6.8	0.75	1.9	1.9	11.9
589405	CGD-16-10	5/8"	39,100	8.5	0.87	2.5	2.2	20.1

\*Design factor 4

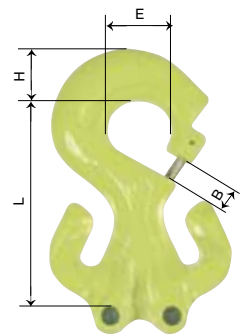

### C-LOK TYPE CL

A connecting link used with MF, MFX, or MFH master links to attach one leg of chain.

The C-Lok can also be used at the bottom of a sling as a sliding choker.

Stock No.	Model	Chain Size Inches	Working Load Limit *(Lbs) at 90°	L	B	E	H	Weight Each (Lbs)
589390	CL-8-10	5/16"	5,700	2.3	0.47	1.3	0.9	1.1
589391	CL-10-10	3/8"	8,800	2.9	0.59	1.6	1.1	2.2
589392	CL-13-10	1/2"	15,000	3.7	0.71	2.0	1.5	4.4
589393	CL-16-10	5/8"	22,600	4.7	0.87	2.5	1.9	8.4

\*Design factor 4

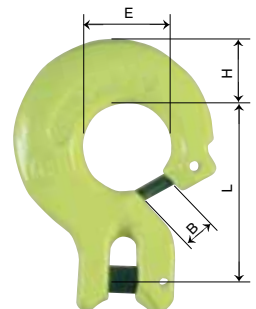

SEE WARNINGS AND USE LIMITATIONS ON PAGES 24-29

Heat number identification allows full product traceability.



**C-Lok Dual Type CLD**

Hook supplied with heavy duty latch.

Clevis prevents mismatched hook & chain.

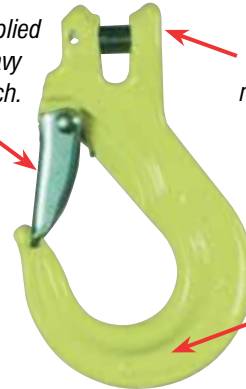

Heat number identification allows full product traceability.

**EGKN Sling Hook**

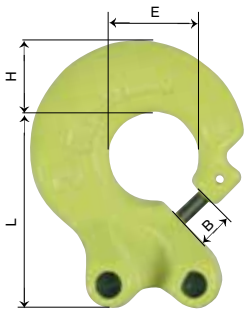

## C-Lok Dual Type CLD

A connecting link used with MF, MFX, or MFH master links to attach two legs

Stock No.	Model	Chain Size Inches	Working Load Limit *(Lbs) at 60°	L	B	E	H	Weight Each (Lbs)
589394	CLD-8-10	5/16"	9,900	2.3	0.47	1.3	1.1	1.3
589395	CLD-10-10	3/8"	15,200	2.9	0.59	1.6	1.5	2.6
589396	CLD-13-10	1/2"	26,000	3.7	0.71	2.0	1.8	6.8
589397	CLD-16-10	5/8"	39,100	4.7	1.0	2.5	2.2	12.1

\*Design factor 4

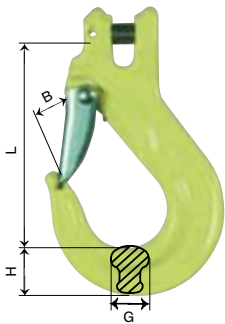

## EGKN Sling Hook

Stock No.	Model	Chain Size Inches	Working Load Limit *(Lbs) at 90°	L	B	G	H	Weight Each (Lbs)
589713	EGKN-8-10	5/16"	5,700	3.7	1.1	0.67	0.87	1.1
589714	EGKN-10-10	3/8"	8,800	4.8	1.4	0.91	1.2	2.2
589715	EGKN-13-10	1/2"	15,000	5.7	1.7	1.1	1.5	5.1
589716	EGKN-16-10	5/8"	22,600	6.7	2.0	1.4	1.8	8.4

\*Design factor 4







Large throat opening make this hook suitable for a wide variety of pick points.

Heat number identification allows full product traceability.

**OKE  
FOUNDRY HOOK**

No reduction of working load limit due to supporting cross bar in saddle of hook.

Heat number identification allows full product traceability.



**GG  
GRAB HOOK**

Heavy duty galvanized retaining collar with square stainless steel locking spring.

Heat number identification allows full product traceability.

**G  
ALLOY COUPLING LINKS**



## OKE FOUNDRY HOOK (EYE TYPE)

Stock No.	Model	Chain Size Inches	Working Load Limit *(Lbs)	L	B	E	F	G	H	Weight Each (Lbs)
589725	OKE-7/8-10	5/16"	5,700	4.8	2.5	1.1	0.45	0.79	1.0	1.5
589727	OKE-10-10	3/8"	8,800	5.9	3.0	1.3	0.59	1.0	1.1	2.9
589728	OKE-13-10	1/2"	15,000	7.2	3.5	1.7	0.75	1.3	1.5	6.2
589729	OKE-16-10	5/8"	22,600	8.5	4.0	2.2	0.91	1.6	1.8	10.8

\*Design factor 4:1

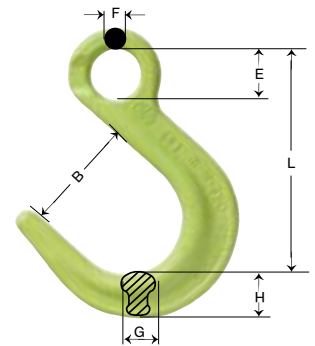

## GG GRAB HOOK (CLEVIS CRADLE TYPE)

Stock No.	Model	Chain Size Inches	Working Load Limit *(Lbs)	L	B	Weight Each (Lbs)
589687	GG-8-10	5/16"	5,700	2.2	0.41	0.88
589688	GG-10-10	3/8"	8,800	3.3	0.47	2.0
589689	GG-13-10	1/2"	15,000	3.8	0.63	4.0
589690	GG-16-10	5/8"	22,600	4.9	0.79	6.8

\*Design factor 4:1

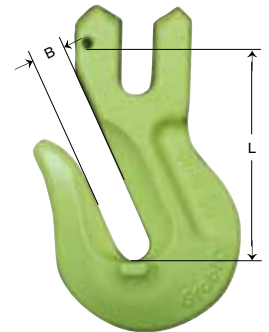

## G ALLOY COUPLING LINKS

Stock No.	Model	Chain Size Inches	Working Load Limit *(Lbs)	L	B	G	E	Weight Each (Lbs)
589674	G-8-10	5/16"	5,700	2.2	0.71	0.35	0.87	0.44
589675	G-10-10	3/8"	8,800	2.7	1.0	0.47	1.0	0.66
589676	G-13-10	1/2"	15,000	3.5	1.1	0.59	1.3	1.5
589677	G-16-10	5/8"	22,600	4.1	1.4	0.75	1.6	2.6

\*Design factor 4:1

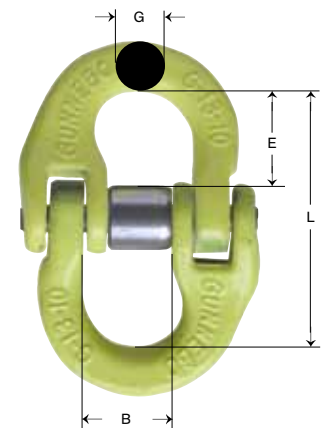

**WARNING**

SEE WARNINGS AND USE LIMITATIONS ON PAGES 24-29

# COMPONENTS

Grip latch locks into point of hook.



Latch is protected and will act as a gauge to signal an unsafe bent hook or latch.

Bushing allows hook to swivel before load is applied.



Release trigger will only operate when hook is unloaded.

Grip latch locks into point of hook.



Ball bearing allows this hook to swivel under load.

**GBK**  
**SELF LOCKING HOOK**

**LBK**  
**SWIVEL EYE GRIP LATCH**

**LKBK**  
**SWIVEL EYE GRIP LATCH**

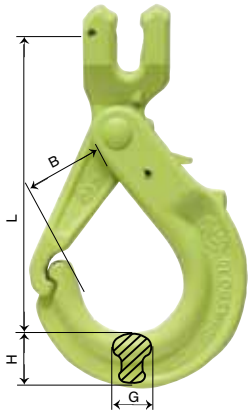

## GBK SELF LOCKING HOOK

Stock No.	Model	Chain Size Inches	Working Load Limit *(Lbs) at 90°	L	B	G	H	Weight Each (Lbs)
589739	GBK-8-10	5/16"	5,700	4.7	1.5	0.79	0.87	1.8
589740	GBK-10-10	3/8"	8,800	5.9	1.9	0.83	1.2	3.1
589741	GBK-13-10	1/2"	15,000	6.8	2.1	1.2	1.5	6.0
589742	GBK-16-10	5/8"	22,600	8.1	2.4	1.5	1.9	9.7

\*Design factor 4

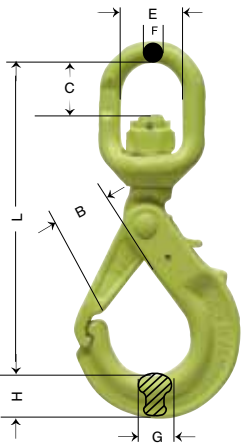

## LBK SWIVEL EYE GRIP LATCH SELF-LOCKING HOOK (WITH BRONZE BUSHING)

Stock No.	Model	Chain Size Inches	Working Load Limit *(Lbs)	L	B	C	E	F	G	H	Weight Each (Lbs)
589751	LBK-7/8-10	5/16"	5,700	6.9	1.5	1.1	1.5	0.47	0.79	0.87	1.8
589753	LBK-10-10	3/8"	8,800	8.4	1.9	1.4	1.7	0.59	0.87	1.1	4.0
589754	LBK-13-10	1/2"	15,000	9.3	2.1	1.9	1.9	0.75	1.1	1.4	8.4
589755	LBK-16-10	5/8"	22,600	12.8	2.7	2.6	2.4	0.91	1.1	1.7	13.2

\*Design factor 4:1

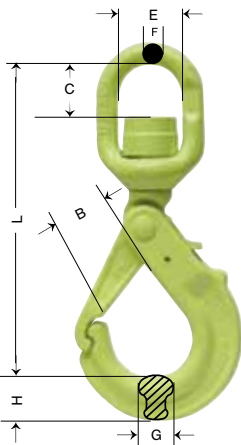

## LKBK SWIVEL EYE GRIP LATCH SELF-LOCKING HOOK (WITH BALL BEARINGS)

Stock No.	Model	Chain Size Inches	Working Load Limit *(Lbs)	L	B	C	E	F	G	H	Weight Each (Lbs)
589963	LKBK-7/8-10	5/16"	5,700	6.9	1.5	1.1	1.5	0.47	0.79	0.87	1.8
589965	LKBK-10-10	3/8"	8,800	8.4	1.9	1.4	1.7	0.59	0.87	1.1	4.0
589966	LKBK-13-10	1/2"	15,000	9.3	2.1	1.9	1.9	0.75	1.1	1.4	8.4
589967	LKBK-16-10	5/8"	22,600	12.6	2.7	2.4	2.4	0.91	1.1	1.7	13.2

\*Design factor 4:1





Instant mounting and positioning on any part of the chain.

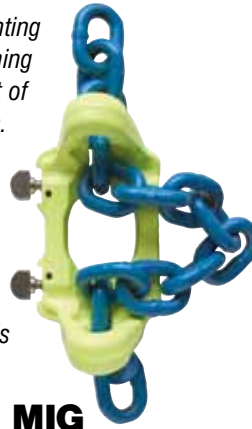

Capacity of shortened leg is not reduced.

Can be set idle on the chain leg when shortening is not required.



## MIG MIDGRAB SHORTENER

### MIG MIDGRAB SHORTENER (REMOVABLE) WITH CLOSE / OPEN DEVICE ON EITHER END

Stock No.	Model	Chain Size Inches**	Working Load Limit *(Lbs)	L	A	B	Weight Each (Lbs)
801036	MIG CC-8-10	5/16"	5,700	3.7	2.0	2.4	1.5
801037	MIG CC-10-10	3/8"	8,800	4.9	2.8	3.0	2.4
801038	MIG CC-13-10	1/2"	15,000	5.9	3.5	3.1	5.7

\*Design factor 4:1 \*\*For use with GrabiQ chain only



### MIG MIDGRAB SHORTENER (NON-REMOVABLE) WITH CLOSE / OPEN DEVICE ON ONE END & LOCKING DEVICE ON OPPOSITE END

Stock No.	Model	Chain Size Inches**	Working Load Limit *(Lbs)	L	A	B	Weight Each (Lbs)
801051	MIG CL-8-10	5/16"	5,700	3.7	2.0	2.4	1.5
801052	MIG CL-10-10	3/8"	8,800	4.9	2.8	3.0	2.4
801053	MIG CL-13-10	1/2"	15,000	5.9	3.5	3.1	5.7

\*Design factor 4:1 \*\*For use with GrabiQ chain only

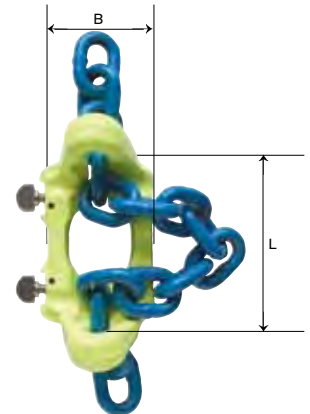

**WARNING**

SEE WARNINGS AND USE LIMITATIONS ON PAGES 24-29

## TOP LOK TYPE TL1

Assembly required for 1-Leg, non-adjustable sling

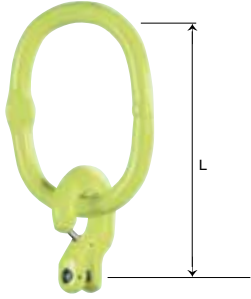

Model	Components Required	Chain Size Inches	Working Load Limit *(Lbs) at 90°	L (In)	Weight Each (Lbs)
TL1-8-10	MF- 86-10 + CL -8-10	5/16"	5,700	7.1	2.0
TL1-10-10	MF- 108-10 + CL-10-10	3/8"	8,800	8.4	3.5
TL1-13-10	MF-1310-10 + CL-13-10	1/2"	15,000	10.1	7.7
TL1-16-10	MF-1613-10 + CL-16-10	5/8"	22,600	12.2	13.2

\*Design factor 4

## TOP LOK TYPE TL2

Assembly required for 2-Leg, non-adjustable sling



Model	Components Required	Chain Size Inches	Working Load Limit *(Lbs) at 60°	L (In)	Weight Each (Lbs)
TL2-8-10	MF- 108-10 + CLD- 8-10	5/16"	9,900	7.8	3.3
TL2-10-10	MF-1310-10 + CLD-10-10	3/8"	15,200	9.1	6.6
TL2-13-10	MF-1613-10 + CLD-13-10	1/2"	26,000	11.2	11.9
TL2-16-10	MF-2016-10 + CLD-16-10	5/8"	39,100	14.0	24.5

\*Design factor 4

## TOP LOK TYPE TL3

Assembly required for 3-Leg, non-adjustable sling

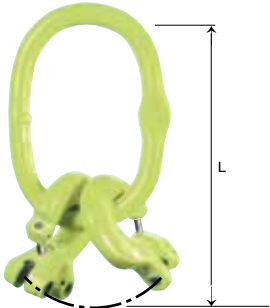

Model	Components Required	Chain Size Inches	Working Load Limit *(Lbs) at 60°	L (In)	Weight Each (Lbs)
TL3-8-10	MF-1310-10 + CLD- 8-10 + CL- 8-10	5/16"	14,800	8.5	6.2
TL3-10-10	MF-1613-10 + CLD-10-10 + CL-10-10	3/8"	22,900	10.3	10.1
TL3-13-10	MF-2016-10 + CLD-13-10 + CL-13-10	1/2"	39,000	13.2	22.7
TL3-16-10	MF-2220-10 + CLD-16-10 + CL-16-10	5/8"	58,700	14.4	37.5

\*Design factor 4

## TOP LOK TYPE TL4

Assembly required for 4-Leg, non-adjustable sling

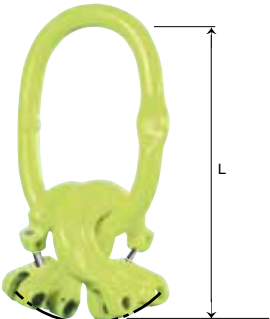

Model	Components Required	Chain Size Inches	Working Load Limit *(Lbs) at 60°	L (In)	Weight Each (Lbs)
TL4-8-10	MF-1310-10 + 2 CLD- 8-10	5/16"	14,800	8.5	6.8
TL4-10-10	MF-1613-10 + 2 CLD-10-10	3/8"	22,900	10.3	11.5
TL4-13-10	MF-2016-10 + 2 CLD-13-10	1/2"	39,000	13.2	25.3
TL4-16-10	MF-2220-10 + 2 CLD-16-10	5/8"	58,700	14.4	42.3

\*Design factor 4

## TOP GRAB TYPE TG1

Assembly required for 1-Leg fully adjustable sling

Model	Components Required	Chain Size Inches	Working Load Limit *(Lbs) at 90°	L (In)	Weight Each (Lbs)
TGI-8-10	MF- 86- 10 + CG- 8-10	5/16"	5,700	8.9	2.6
TGI-10-10	MF- 108-10 + CG-10-10	3/8"	8,800	10.8	4.8
TGI-13-10	MF-1310-10 + CG-13-10	1/2"	15,000	13.1	10.4
TGI-16-10	MF-1613-10 + CG-16-10	5/8"	22,600	16.0	18.3

\*Design factor 4



## TOP GRAB TYPE TG2

Assembly required for 2-Leg fully adjustable sling

Model	Components Required	Chain Size Inches	Working Load Limit *(Lbs) at 60°	L (In)	Weight Each (Lbs)
TG2-8-10	MF-108- 10 + CGD- 8-10	5/16"	9,900	9.7	4.4
TG2-10-10	MF-1310-10 + CGD-10-10	3/8"	15,200	11.5	8.8
TG2-13-10	MF-1613-10 + CGD-13-10	1/2"	26,000	14.3	17.0
TG2-16-10	MF-2016-10 + CGD-16-10	5/8"	39,100	17.9	33.7

\*Design factor 4

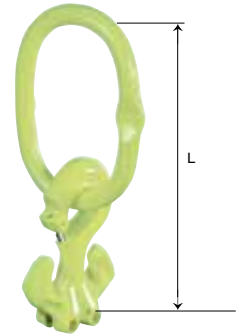

## TOP GRAB TYPE TG3

Assembly required for 3-Leg fully adjustable sling

Model	Components Required	Chain Size Inches	Working Load Limit *(Lbs) at 60°	L (In)	Weight Each (Lbs)
TG3-8-10	MF-1310-10 + CGD- 8-10 + CG- 8-10	5/16"	14,800	10.5	7.9
TG3-10-10	MF-1613-10 + CGD-10-10 + CG-10-10	3/8"	22,900	12.7	13.7
TG3-13-10	MF-2016-10 + CGD-13-10 + CG-13-10	1/2"	39,000	16.3	30.4
TG3-16-10	MF-2220-10 + CGD-16-10 + CG-16-10	5/8"	58,700	18.3	51.8

\*Design factor 4

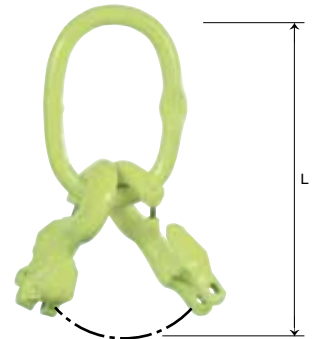

## TOP GRAB TYPE TG4

Assembly required for 4-Leg fully adjustable sling

Model	Components Required	Chain Size Inches	Working Load Limit *(Lbs) at 60°	L (In)	Weight Each (Lbs)
TG4-8-10	MF-1310-10 + 2 CGD- 8-10	5/16"	14,800	10.5	9.0
TG4-10-10	MF-1613-10 + 2 CGD-10-10	3/8"	22,900	12.7	15.9
TG4-13-10	MF-2016-10 + 2 CGD-13-10	1/2"	39,000	16.3	35.5
TG4-16-10	MF-2220-10 + 2 CGD-16-10	5/8"	58,700	18.3	60.8

\*Design factor 4

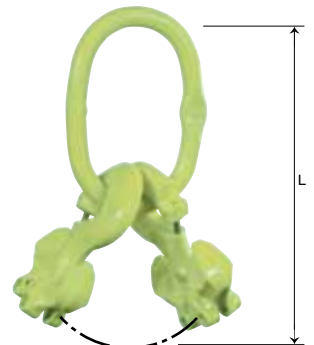

**WARNING**

SEE WARNINGS AND USE LIMITATIONS ON PAGES 24-29





**BS**



**BSG**



**BSGG**

## SINGLE BASKET TYPE BS

Single leg basket sling with fixed length leg. Not adjustable

Model	Components Required	Chain Size Inches	Working Load Limit *(Lbs) at 60°	L (In)	Weight Each (Lbs)
BS-8-10	MF-108- 10 + 2 CL-8- 10	5/16"	9,900	7.8	3.7
BS-10-10	MF-1310-10 + 2 CL-10-10	3/8"	15,200	9.2	7.3
BS-13-10	MF-1613-10 + 2 CL-13-10	1/2"	26,000	11.3	13.7
BS-16-10	MF-2016-10 + 2 CL-16-10	5/8"	39,100	14.1	28.0

\*Design factor 4

L = Effective length of components



## SINGLE BASKET TYPE BSG

Single leg basket sling, adjustable from one side only

Model	Components Required	Chain Size Inches	Working Load Limit *(Lbs) at 60°	L (In)	L <sup>1</sup> (In)	Weight Each (Lbs)
BSG-8-10	MF- 108-10 + CG- 8-10 + CL- 8-10	5/16"	9,900	9.7	7.8	4.4
BSG-10-10	MF-1310-10 + CG-10-10 + CL-10-10	3/8"	15,200	11.6	9.2	8.6
BSG-13-10	MF-1613-10 + CG-13-10 + CL-13-10	1/2"	26,000	14.3	11.3	16.3
BSG-16-10	MF-2016-10 + CG-16-10 + CL-16-10	5/8"	39,100	17.9	14.1	33.1

\*Design factor 4

L = Effective length of MF + CG

L<sup>1</sup> = Effective length of MF + CL



## SINGLE BASKET TYPE BSGG

Single leg basket sling, adjustable from either side

Model	Components Required	Chain Size Inches	Working Load Limit *(Lbs) at 60°	L (In)	Weight Each (Lbs)
BSGG-8-10	MF-108- 10 + 2 CG- 8-10	5/16"	9,900	9.7	5.1
BSGG-10-10	MF-1310-10 + 2 CG-10-10	3/8"	15,200	11.6	9.9
BSGG-13-10	MF-1613-10 + 2 CG-13-10	1/2"	26,000	14.3	12.3
BSGG-16-10	MF-2016-10 + 2 CG-16-10	5/8"	39,100	17.9	38.1

\*Design factor 4

L = Effective length of components



**WARNING**

SEE WARNINGS AND USE LIMITATIONS ON PAGES 24-29



**BD**



**BDG**



**BDGG**

## DOUBLE BASKET TYPE BD

Double leg basket sling, with fixed length for each leg. Not adjustable

Model	Components Required	Chain Size Inches	Working Load Limit *(Lbs)	L (In)	Weight Each (Lbs)
BD-8-10	MF-1310-10 + 2 CLD- 8-10	5/16"	14,800	8.5	6.8
BD-10-10	MF-1613-10 + 2 CLD-10-10	3/8"	22,900	10.3	11.5
BD-13-10	MF-2016-10 + 2 CLD-13-10	1/2"	39,000	13.1	25.3
BD-16-10	MF-2220-10 + 2 CLD-16-10	5/8"	58,700	14.4	42.3

\*Design factor 4

L = Effective length of components



## DOUBLE BASKET TYPE BDG

Double leg basket sling, with either leg adjustable from one side only

Model	Components Required	Chain Size Inches	Working Load Limit *(Lbs)	L (In)	L <sup>1</sup> (In)	Weight Each (Lbs)
BDG-8-10	MF-1310-10 + CGD- 8-10 + CLD- 8-10	5/16"	14,800	10.5	8.5	7.9
BDG-10-10	MF-1613-10 + CGD-10-10 + CLD-10-10	3/8"	22,900	12.7	10.3	13.7
BDG-13-10	MF-2016-10 + CGD-13-10 + CLD-13-10	1/2"	39,000	16.3	13.1	30.4
BDG-16-10	MF-2220-10 + CGD-16-10 + CLD-16-10	5/8"	58,700	18.3	14.4	51.6

\*Design factor 4

L = Effective length of MF + CGD

L<sup>1</sup> = Effective length of MF + CLD



## DOUBLE BASKET TYPE BDGG

Double leg basket sling, with either leg adjustable from both sides

Model	Components Required	Chain Size Inches	Working Load Limit *(Lbs)	L (In)	Weight Each (Lbs)
BDGG-8-10	MF-1310-10 + 2 CGD- 8-10	5/16"	14,800	10.5	9.0
BDGG-10-10	MF-1613-10 + 2 CGD-10-10	3/8"	22,900	12.7	15.9
BDGG-13-10	MF-2016-10 + 2 CGD-13-10	1/2"	39,000	16.3	35.5
BDGG-16-10	MF-2220-10 + 2 CGD-16-10	5/8"	58,700	18.3	60.8

\*Design factor 4

L = Effective length of components



SEE WARNINGS AND USE LIMITATIONS ON PAGES 24-29



**The Clevis Connection Set (CLS) consists of one special alloy steel grade 10 load pin and one spring keeper pin. It is uniform for all GrabiQ components.**

## CLS DISMOUNTABLE CLEVIS LOAD PIN SET

Each set includes one grade 10 load pin and one spring retaining pin.  
Fits: MG, MGD, CG, CGD, CL, CLD, EGK, EGKN, BKG, GBK, GG, & GC

Stock No.	Model	Connector Size	Weight Each (Lbs)
589437	CLS-8-10	5/16"	0.1
589438	CLS-10-10	3/8"	0.2
589439	CLS-13-10	1/2"	0.2
589504	CLS-16-10	5/8"	0.3

## SPARE PARTS FOR GBK, LBK, & LKBK "GRIP LATCH" STYLE HOOKS



Stock No.	Model	Trade Size MM	Trade Size Inch	Weight Each (Lbs)
511811	RD OBK/GBK-7/8	8	5/16"	0.1
511821	RD OBK/GBK-10	10	3/8"	0.1
511831	RD OBK/GBK-13	13	1/2"	0.1
511841	RD OBK/GBK-16	16	5/8"	0.4

## EGKNS LATCH SET

Replacement latch kit for GrabiQ EGKN hook.  
Set includes Latch, Latch Spring, and Rivet

Stock No.	Model	Connector Size	Weight Each (Lbs)
589447	RDEKN-7/8	9/32"	0.1
589448	RDEKN-10	3/8"	0.2
589449	RDEKN-13	1/2"	0.3
589450	RDEKN-16	5/8"	0.4

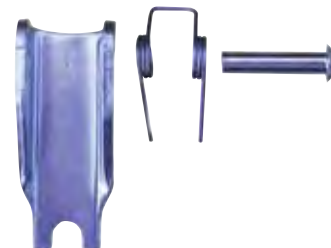

## Warning Tag



547302

Chain sling warning tag from high density, durable plastic

## Metal Chain Sling Tag



547303

Identification tag for alloy chain slings

## Safety Warning Kit



683466

Safety warning kit for alloy chain slings

## COUPLING PIN & LOCK WASHER SET

Stock No.	Model	Trade Size MM	Trade Size Inch	Working Load Limit	Weight Each (Lbs)
589777	SKA- 7/8-10	8	9/32"	5,700	0.04
589779	SKA-10-10	10	3/8"	8,800	0.1
589780	SKA-13-10	13	1/2"	15,000	0.2
589781	SKA-16-10	16	5/8"	22,600	0.3



\*Design factor 4:1

## MIG MIDGRAB LOCKING DEVICE TYPE "L"



Stock No.	Model	Trade Size MM	Trade Size Inch	Weight Each (Lbs)
590052	L-8	8	5/16"	1.4
590053	L-10	10	3/8"	2.4
590054	L-13	13	1/2"	5.7

For fixed mounting on a chain leg. Cannot be removed.

## MIG MIDGRAB OPEN / CLOSE DEVICE TYPE "C"



Stock No.	Model	Trade Size MM	Trade Size Inch	Weight Each (Lbs)
590037	C-8	8	5/16"	1.4
590038	C-10	10	3/8"	2.4
590039	C-13	13	1/2"	5.7

Spring operated lock can be placed either in the open or closed position. Can be removed from chain leg



SEE WARNINGS AND USE LIMITATIONS ON PAGES 24-29

## C-connection – C-Grab/C-lok to MF, MFX, & MTX

### C-CONNECTOR RETAINING PIN SET

Stock No.	Model	Connector Size	Weight Each (Lbs)
589434	CS- 8 -10	5/16"	0.1
589435	CS-10-10	3/8"	0.1
589436	CS-13-10	1/2"	0.2
589503	CS-16-10	5/8"	0.2



**Pin set includes all the components required for dismountable (CS) mounting of C-Grab or C-Lok fittings to MF, MFX and MTX master links. Fits: CG, CGD, CL, and CLD. Kit includes one solid retainer pin and one spring pin keeper.**

### QUICKPIN - RETRACTABLE RETAINER PIN \*



Model	Model	Trade Size MM	Trade Size Inch	Weight Each (Lbs)
589996	Quickpin-8	8	5/16"	0.1
589997	Quickpin-10	10	3/8"	0.1
589998	Quickpin-13	13	1/2"	0.1
589999	Quickpin-16	16	5/8"	0.1

\* Use ONLY as a latch with CL or CG as bottom fittings for choke applications.

Gunnebo Lifting Industrier AB has obtained license rights world-wide for the entire GrabiQ range. In US the following patents and TM apply:

Product type CG - US pat 5,765,891 and 5,851,040  
 Product type CLD - US pat 5,851,040  
 Product type MG - US pat 5,829,810  
 Product type RLP - US pat 5,248,176

Product type MGD - US pat 5,829,810 and UD Des D 453,471 S  
 Product type CGD - US pat 5,829,810  
 Product type CL - US pat 5,851,040

GrabiQ - US reg TM 2,650,184  
 GrabiQ - RH Hook - US pat 5,884,950  
 GrabiQ - MIG Hook - US pat pend.



**MG-BKG**



**MGD-BKG**



**TG3-BKG**



**TG4-BKG**



**TG1-CL**



**TG2-CG**



**TG3-P**

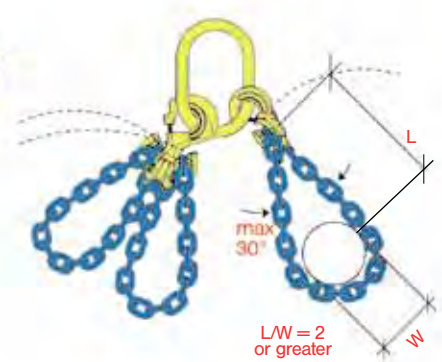

**MG-MG**



**MG-P**



**BDGG**



## GrabiQ Sling Type Naming Code

**The sling type code is: name of component or assembly at top of sling and name of component at bottom of sling.**

*Most popular top assemblies are listed pages 8 - 11. Bottom fitting component codes include MF, CG, CL, EGK, EGKN, BKG, GBK, GG, G, OKE, LBK, LKBK, and P (Plain)*

*(Examples: "MF-MF" is a single leg sling with a master link on each end.*

*"TL3-EGKN" is a triple leg sling with a master link at the top and a sling hook at the bottom.)*

---

### SINGLE LEG

---



**EGKN-EGKN**



**MG-EGKN**



**MG-P**



**MG-BKG**



**MG-CL**



**MG-CG**



**MG-MG**



**MF-MF**

## SINGLE LEG



TGI-EGKN



TGI-BKG



TGI-CL



TGI-CG



TGI-P



TLI-EGKN



TLI-BKG



TLI-CL



TLI-CG

## DOUBLE LEG



MGD-EGKN



MGD-BKG



MGD-CL



MGD-CG



MGD-P



TG2-EGKN



TG2-BKG



TG2-CL



TG2-CG



TG2-P

## DOUBLE LEG



TL2-EGKN



TL2-BKG



TL2-CL



TL2-CG

## TRIPLE LEG



TG3-EGKN



TG3-BKG



TG3-CL



TG3-CG



TG3-P



TL3-EGKN



TL3-BKG



TL3-CL



TL3-CG



## QUADRUPLE LEG



TL4-CG



TL4-CL



TL4-EGKN



TL4-BKG



TG4-CL



TG4-CG



TG4-EGKN



TG4-P



TG4-BKG

## BASKET SLINGS



BS



BSG



BSGG



BD



BDG



BDGG



# TIPS FOR GRABIQ SLING ASSEMBLY

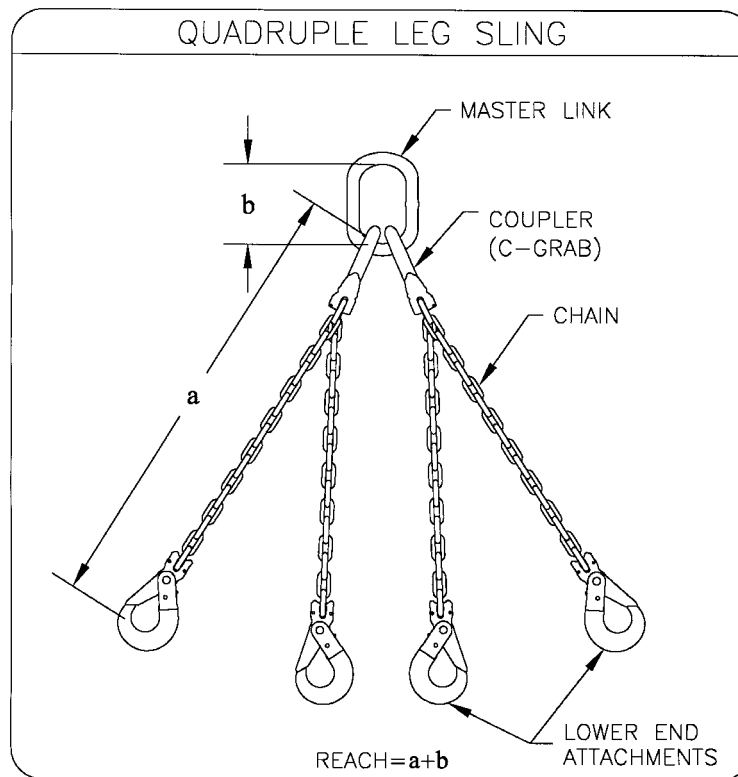

1. It is a common practice, when possible, to keep all hooks in the same plane as the master link. This is easily accomplished on 1, 2, & 4 leg slings. It is not possible with 3-leg GrabiQ slings when single and dual fittings are mixed.
2. It is a common practice, when possible, to attach hooks so that latches point away from the master link.
3. **Mixing GrabiQ fittings:** Adding two additional chain links to the CL & CLD gives the same effective reach as CG & CGD. The MG & MGD have the same effective reach.
4. A metal ID tag must always be attached to a chain sling, showing serial number, size, reach, Working Load Limit at angle of lift and manufacturer.
5. The reach of the sling is the length measured from the load-bearing surface of the master link to the load-bearing surface of the hook or lower terminal (as shown in illustration).
6. Normally, the master link will have a maximum of two connecting links, **CG, CGD, CL, or CLD**. The maximum number of connecting links that can ever be mounted on a single master link is three, when constructing a double leg basket.
7. A GrabiQ sling can never have more than four independent legs or two basket legs.
8. **Attaching CG, CGD, CL, & CLD connectors to MF, MFX, & MTX Master Links:** Insert the connector onto the master link at the engineered flat. C-Connecting links are normally attached to the master link using the *Dismountable Connecting Set type CS* or the *Permanent Connecting Set type CP*. Each C-Connector includes one solid retainer pin, 1 larger rolled spring keeper pin and 1 smaller rolled spring keeper pin. When the dismountable connecting set is used the sling can be disassembled for repair. The permanent connecting set cannot be disassembled for repair.
  - a. CS – 1<sup>st</sup> install the solid retainer pin. 2<sup>nd</sup> Drive the smaller rolled spring keeper pin through the hole provided at a right angle to the solid retainer pin. The fit should be very snug.
  - b. CP – 1<sup>st</sup> install the solid retainer pin. 2<sup>nd</sup> Drive the larger rolled spring keeper pin into the same hole, directly behind solid retainer pin. The fit should be very snug.

# GrabIQ™ Chain Sling Warnings and Use Limitations

This document contains warnings and use limitation information applicable to Gunnebo Lifting's GrabIQ G100 Alloy Steel Chain Slings and components and is furnished with all Gunnebo Johnson Corporation shipments. Component distributors and lift system manufacturers must pass on this information in their warnings and use limitation literature where Gunnebo Lifting G100 chain or components are involved.

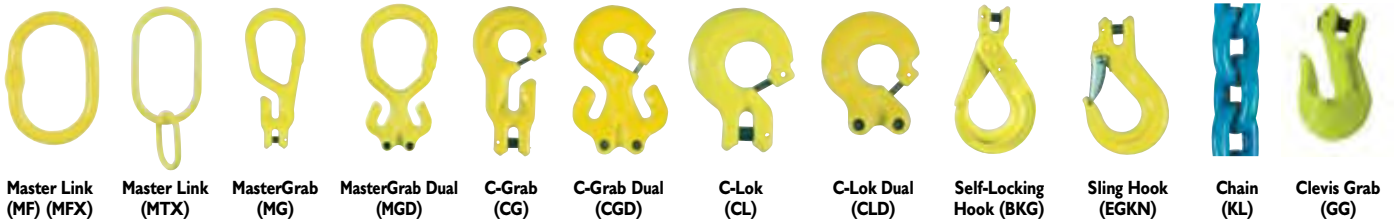



ALLOY STEEL CHAIN SLINGS

**WARNING**

CHAIN SLING FAILURE CAN CAUSE

**DEATH OR INJURY.**

SLING FAILURE RESULTS FROM MISUSE, DAMAGE, AND EXCESSIVE WEAR



**Protect yourself and others:**

- **Never** use a sling without training.
- **Always** inform yourself...Ask your employer for the manufacturer's sling use limitations.
- **Always** comply with applicable Federal and local regulations.
- **Always** know load weight.
- **Never** use a sling without a legible rated load tag.
- **Never** overload a sling.
- **Never** ride on sling or load.
- **Never** use an improper sling configuration.
- **Never** use a worn-out or damaged sling.
- **Never** use a sling in extreme temperatures.
- **Never** use a sling in acidic conditions.

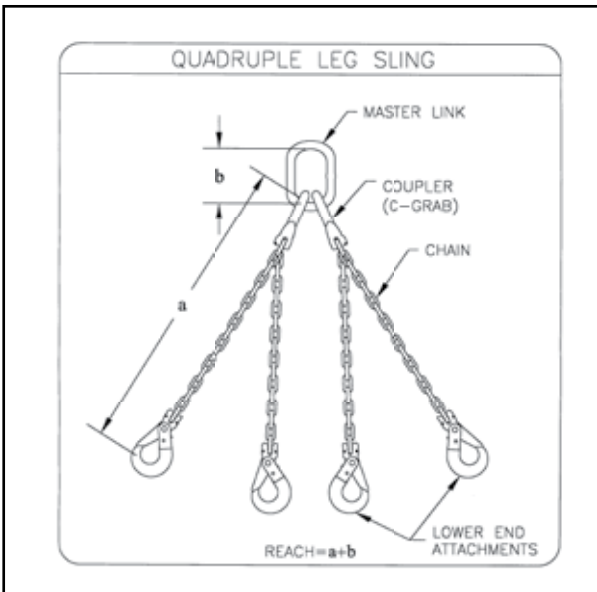

- **Never use a sling without training...** OSHA regulation requires responsible work practice.

"The employer shall permit only those employees qualified by training or experience to operate equipment or machinery" – OSHA 1926.20 (a)(4).

Employee training should include information given in OSHA training literature, ASME B30.9 – 2003 "Slings" and ASME B30.10 – 2005 "Hooks" safety standards and this document.

- **Always inform yourself...** Ask your employer for chain sling safe use instruction.

"The employer shall instruct each employee in the recognition and avoidance of unsafe conditions and the regulations applicable to his work environment to control or eliminate any hazards or other exposure to illness or injury" – OSHA 1926.21 (b)(2).

- **Always comply with applicable Federal and local regulations** ...Federal and local regulations govern worksite activity.

Understand all governing laws and safety standards before use of chain slings. OSHA 1910.184 and 1926.251 regulates chain sling safe operating practices, product identification, inspection requirements, and use limitations. ASME B30.9-2003 "Sling" safety standard provides additional recommendations for chain sling use.

"If a particular standard is specifically applicable to a condition, practice, means, method, operation, or process, it shall prevail over any different general standard..." – OSHA 1910.5(c)(1).

Contact OSHA at (800) 321-6742, or [www.OSHA.gov](http://www.OSHA.gov) and ASME at (800) 843-2763, or [www.ASME.org](http://www.ASME.org) for reference assistance.

- **Always know load weight** ...Avoid sling failure.

"The rated load of the sling shall not be exceeded." – ASME B30.9-1.10.1(c).

Weight of the load to be lifted must be known for determination of proper sling configuration and working load limit.

- **Never use a sling without a legible identification tag...** Sling Identification is required to ensure proper sling application.

“Alloy steel chain slings shall have permanently affixed durable identification stating size, grade, rated capacity, and reach.” - OSHA 1910.184 (e) (1).

“Hooks, rings...or other attachments shall have a rated capacity equal to the alloy steel chain with which they are used or the sling shall not be used in excess of the rated capacity of the weakest component...” - OSHA 1910.184(e)(2)(1).

“Makeshift links or fasteners shall not be used.” - OSHA 1910.184(e)(2)(ii).

GrabiQ components shall be used only with Gunnebo Lifting Grade 100 Alloy Steel Chain.

Product identifier is forged into GrabiQ sling components and is designated as GrabiQ-(Model Designator) - (Trade Size) - (Grade); Example: GrabiQ-MG-13-10.

Gunnebo Johnson Corporation has available a blank identification tag, attached by a cable tie, to be stamped with sling WLL, minimum working range angle, serial number, chain size, grade, reach, type and manufacturer. Order 547303 for replacement.

Grade of component with the lowest breaking strength shall be specified on the identification tag. Nonstandard grades shall be designated by “NS”.

Working Load Limit (WLL) is the maximum working load for a specified working range. Sling working range includes sling leg angles from 90° to a specified minimum. The specified minimum working range angle is given on the identification tag.

Working load is to be applied vertically to a sling assembly having symmetric leg angles. WLL applies to loads lifted vertically and does not include torsional, binding, shock or non-symmetrical load effects.

Gunnebo Lifting's GrabiQ Grade 100 Alloy Steel Chain Sling Working Load Limits for selected working ranges of symmetric sling leg angles are listed in pounds and given in TABLE 1. No chain sling shall be rigged with a leg angle less than 30° from the horizontal.

Double Leg Sling WLL for an alternate working range of symmetric sling leg angles equals (=) 2 × TABLE 1 single leg WLL × sine of the minimum working range angle.

Triple and Quadruple Leg Sling WLL for an alternate working range of symmetric sling leg angles equals (=) 3 × TABLE 1 single leg WLL × sine of the minimum working range angle.

TABLE 2 lists for convenience sine values for selected sling leg angles.

TABLE 2

Angle	Sine	Angle	Sine	Angle	Sine
85	0.9962	70	0.9397	50	0.7660
80	0.9848	65	0.9063	40	0.6482
75	0.9659	55	0.8192	35	0.5736

Multi Leg Sling WLL for non-symmetrical loading can only be determined by engineering analysis of the specific rigging condition. In the absence of an engineering analysis, WLL shall be equal to single leg sling WLL given in TABLE 1.

Choked endless chain sling WLL for selected working ranges of symmetric leg angles are listed in pounds and given in Table 3.

TABLE 3 – CHOKED ENDLESS CHAIN SLING WORKING LOAD LIMITS\* IN POUNDS - DESIGN FACTOR OF 4

	GUNNEBO LIFTING G100		CHOKED		
	CHAIN SIZE		ENDLESS		
	MN	IN	90°	90°-60°	90°-45°
	8	5/16	8500	7400	6100
	10	3/8	13200	11400	9300
	13	1/2	22500	19500	15900
	16	5/8	33900	29300	24000

\*Working Load Limits are valid between temperatures of -40° and 400°F

Choked chain sling WLL is affected by choke and choke angle. Table 4 illustrates choke angle and gives Choked WLLs as a percentage of Table 1 WLL for full range of choke angles.

TABLE 4







	Choke Angle	Percentage of TABLE 1 WLL
	120 - 180	80%
90 - 119	70%	
60 - 89	60%	
30 - 59	50%	
0 - 29	40%	

TABLE 1

## GrabiQ G100 ALLOY STEEL CHAIN SLING WORKING LOAD LIMITS\* IN POUNDS – DESIGN FACTOR OF 4

GUNNEBO LIFTING G100 CHAIN SIZE		SINGLE LEG	DOUBLE LEG			TRIPLE & QUAD LEG		
MM.	IN.							
		90°	90° - 60°	90° - 45°	90° - 30°	90° - 60°	90° - 45°	90° - 30°
8	5/16	5,700	9,900	8,100	5,700	14,800	12,100	8,500
10	3/8	8,800	15,200	12,400	8,800	22,900	18,700	13,200
13	1/2	15,000	26,000	21,200	15,000	39,000	31,800	22,500
16	5/8	22,600	39,100	32,000	22,600	58,700	47,900	33,900

\*Working Load Limits are valid between temperatures of -40° and 400°F

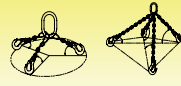
Gunnebo Lifting's GrabiQ Grade 100 "Loop Leg" Sling Working Load Limits for selected working ranges of symmetric sling leg angles are listed in pounds and given in Table 5.

A "Loop Leg" hitch is a type of basket hitch made with a single GrabiQ fitting having an integral chain pocket. The Loop Leg Hitch included angle is limited to a maximum of 30° or a L/W ratio of 2 or greater and shall not be rigged with a leg angle less than 45° from horizontal as illustrated by the figure below. Sling leg angle is defined by the leg of the "Loop" with the smallest angle.

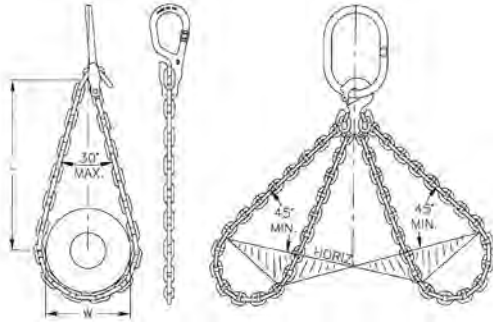

A basket hitch made with both chain ends terminated by a GrabiQ Clevis connection on the same fitting or to a separate fitting is a conventional basket hitch and is illustrated by the figure below.

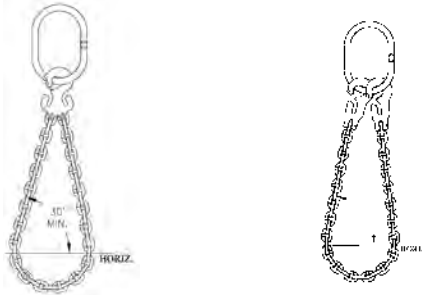

Gunnebo Lifting's GrabiQ Grade 100 Conventional Basket Sling working load limits for selected working ranges of symmetric sling leg angles are listed in pounds and given in Table 1. Conventional basket hitch is limited to single and double leg slings and shall not be rigged with a leg angle less than 30° from the horizontal.

- **Never overload a sling...** Understand Working Load Limits.

"Slings shall not be loaded in excess of their rated capacities." – OSHA 1910.184 (c)(4).

"The design factor for alloy steel chain slings shall be a minimum of 4" – ASME B30.9-1.4.

Standard Gunnebo Lifting Working Load Limits (WLL) are based on a 4 design factor. Lift dynamics, duty cycle and hitch type may require an increased design factor, hence a reduced WLL. Inattention to required design factor can result in sling overload. Contact Gunnebo Johnson Corporation Service Department for assistance at (800) 331-5460.

Sling WLL depends on sling leg angle. The WLL for a sling is reduced as the sling leg angle with the horizontal gets smaller. This fact applies to all multi-leg slings and must not be ignored.

The following diagram illustrates the effect of sling leg angle on the WLL for a 2-leg sling.

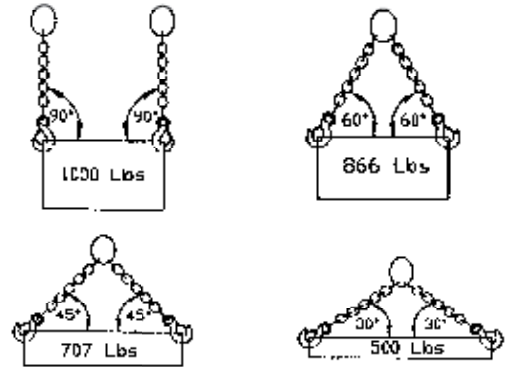

The WLL of a sling with a 30° leg angle is 50% of the WLL for the same sling with a 90° leg angle. Inattention to the effect of sling leg angle can result in sling overload.

Chain sling WLL is to be reduced in accordance with TABLE 6 when chain is rigged over an edge radius (R) less than two (2) × the chain rod diameter (d).

Reduced WLL equals chain sling WLL from identification tag × reduction factor.

TABLE 5

## GrabiQ™ G100 ALLOY STEEL CHAIN "LOOP LEG" SLING WORKING LOAD LIMITS\* IN POUNDS – DESIGN FACTOR OF 4

GUNNEBO LIFTING G100 CHAIN SIZE		SINGLE LEG	DOUBLE LEG		TRIPLE & QUAD LEG	
MM.	IN.	90°	90° - 60°	90° - 45°	90° - 60°	90° - 45°
8	5/16	5,700	9,900	8,100	14,800	12,100
10	3/8	8,800	15,200	12,400	22,900	18,700
13	1/2	15,000	26,000	21,200	39,000	31,800
16	5/8	22,600	39,100	32,000	58,700	47,900

\*Working Load Limits are valid between temperatures of -40° and 400°F



TABLE 6

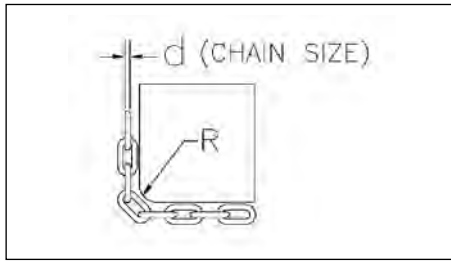

Edge Radius	$R > 2 \times \text{Chain } d$	$R > \text{Chain } d$	$R < \text{Chain } d$
Reduction Factor	1.0	0.7	0.5

• **Never ride on sling or load...**Avoid death or injury.

Sling use regulation requires: "All employees shall be kept clear of loads about to be lifted and of suspended loads." – OSHA 1910.184 (c) (9).

General worksite regulations require "No hoisting, lowering, swinging or traveling shall be done while anyone is on the load or hook assembly." – OSHA 1910.180 (h) (3) (v).

Construction worksite regulation stipulates: "The use of a crane or derrick to hoist employees on a personnel platform is *prohibited*, *except* when the erection, use, and dismantling, of conventional means of reaching the worksite, such as a personnel hoist, ladder, stairway, aerial lift, elevating work platform or scaffold, would be *more hazardous* or is *not possible* because of structural design or worksite conditions." – OSHA 1926.550 (g) (2).

GrabiQ alloy steel chain slings shall not be used to rig personnel platforms.

Self-locking hooks shall not be used in personnel lift systems unless complying with applicable federal or local lift system and fall arrest regulations and TABLE 8A and TABLE 8B.

• **Never rig a sling to a load improperly...**Avoid dropped loads and sling damage.

"Safe operating practices..." – OSHA 1910.184 (c)

"Operating practices..." – ASME B30.5-3.2

"Operating practices..." – ASME B30.9-1.10

"Operating practices..."

- (c) Load shall be centered in the base (bowl/saddle) of the hook to prevent point loading of the hook. (See Figure 1a, 1b, & 1c)
- (d) Hooks shall not be used in such a manner as to place a side load or back load on the hook. (See Figure 2a & 2b)
- (e) When using a device to close the throat opening of the hook, care shall be taken that the load is not carried by the closing device. (See Figure 3a & 3b)
- (f) Hands, fingers, and body shall be kept from between hook and load.

- (i) The use of a hook with a latch does not preclude the inadvertent detachment of a slack sling or a load from the hook. Visual verification of proper hook engagement is required in all cases.
- (j) Self-locking hooks shall be locked during use.
- (k) When a hook is equipped with a latch, the latch should not be restrained from closing during use." – ASME B30.10-1.3.

Hooks shall not be rigged with more than two (2) sling legs in the hook saddle and sling leg angles shall not be greater than 45° from hook centerline. (Figure 1b)

Hooks shall be rigged with a master ring or shackle when three (3) or more sling legs are used or sling leg angles exceed 45° from hook centerline. (Figure 1c)

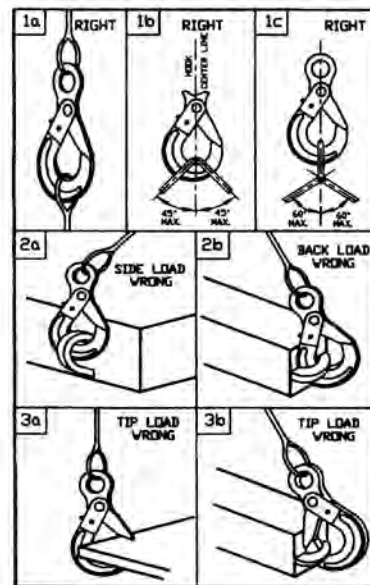

- Sling leg angle shall not be less than 30° from the horizontal.
- Slings shall be shortened with a shortening fitting only and not with knots or bolts or other makeshift devices.
- Sling legs shall not be kinked or twisted.
- Sling hooks shall not be point loaded.
- Sling hook latch may be mandatory by regulation, safety codes, or insurance.
- Slings used in a basket hitch shall have the loads balanced to prevent slipping.
- Slings shall be securely attached to their loads.
- Slings shall be padded or protected from the edges of their loads when the edge radius is less than .5 of the chain rod diameter (d). See TABLE 6.
- Sling shall be rigged to prevent chain from sliding over a load edge while lifting.



The maximum number of GrabiQ fittings to be connected to a master link is three as illustrated in Figure 2.

FIGURE 2

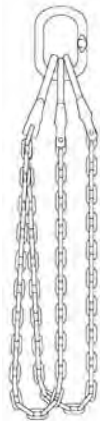

Sling shall not be used unless the GrabiQ coupler of at least one end of each chain leg is secured to the masterlink by one of the retainer and keeper methods illustrated in Figures 3 & 4.

Free end of sling leg when connected to a master link with a GrabiQ coupler does not require a retainer. However, either method illustrated in Figures 3 and 4 may be used when desired.

FIGURE 3

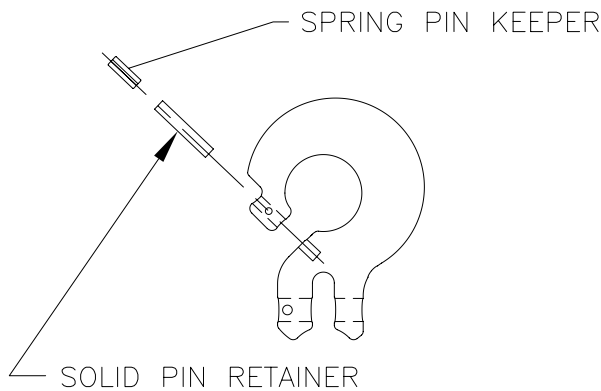
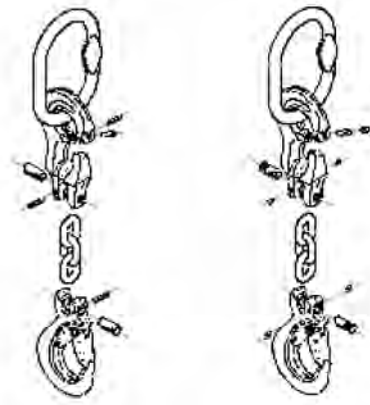
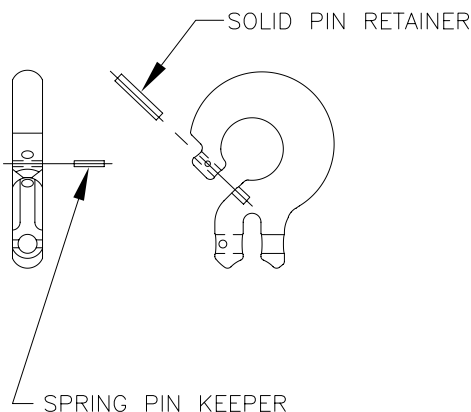

FIGURE 4



DISMOUNTABLE CONNECTIONS

PERMANENT CONNECTIONS

Gunnebo Lifting is now offering dismountable and permanent connections.

- **Never use a worn-out or damaged sling.**

“Each day before being used, the sling and all fastenings and attachments shall be inspected for damage or defects by a competent person designated by the employer. Additional inspections shall be performed during sling use where service conditions warrant. Damaged or defective slings shall be immediately removed from service” - OSHA 1910.184 (d).

“In addition to the inspection required by paragraph 1910.184(d), a thorough periodic inspection shall be made on a regular basis, to be determined on the basis of (A) frequency of sling use; (B) severity of service conditions; (C) nature of lifts being made; and (D) experience gained on the service life of slings used in similar circumstances. Such inspections shall in no event be at intervals greater than once every 12 months.” - OSHA 1910.184(e)(3)(i).

“The thorough inspection of alloy steel chain slings shall be performed by a competent person designated by the employer, and shall include a thorough inspection for wear, defective welds, deformation and increase in length. Where such defects or deterioration are present, the sling shall be immediately removed from service.” – OSHA 1910.184(e)(3)(iii).

“Worn or damaged alloy steel chain slings or attachments shall not be used until repaired.” – OSHA 1910.184(e)(7)(i).

Chain sling with reach longer than given on identification tag shall be immediately removed from service and evaluated for wear and material stretch.

Chain link wear is limited by minimum cross-sectional dimensions given in TABLE 7. Chain worn below the given limits shall be removed from service.

Chain Sling connector or attachment with wear greater than 10 percent of the original dimension for any cross-section shall be removed from service.

TABLE 7

Minimum Cross-Section			
Nominal Chain Size		Dimensional Limit	
mm	in	mm	in
8	5/16	6.9	.272
10	3/8	8.7	.342
13	1/2	11.3	.443
16	5/8	13.9	.546

Chain sling GrabiQ coupler, chain, master ring, sub-link, hook or attachment that is broken, cracked, bent, stretched or twisted shall be removed from service and shall not be repaired.

Chain sling with a GrabiQ coupler, chain, master ring, sub-link, hook or attachment nicked, gouged or lapped shall be removed from service and shall not be returned to service unless properly repaired.

Hook latch, when required, shall be fully functional and properly seated.

Self-locking hook with latch tip opening greater than amount given in Table 8A and 8B shall be removed from service and shall not be returned to service unless properly repaired.

**Table 8A**

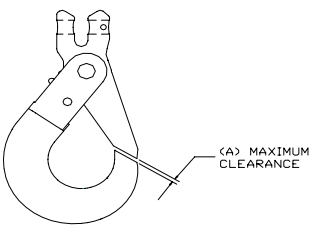

Trade Size		(A) Max. Clearance			
		Material Handling		Personnel Handling	
MM	IN	MM	IN	MM	IN
5/6	7/32	2.2	.09	1.5	.06
7/8	9/32	2.7	.11	1.9	.07
7	9/32	2.7	.11	1.9	.07
8	5/16	2.7	.11	1.9	.07
10	3/8	3.2	.13	2.2	.09
13	1/2	3.7	.15	2.6	.10
16	5/8	4.7	.19	3.2	.13

**Table 8B**

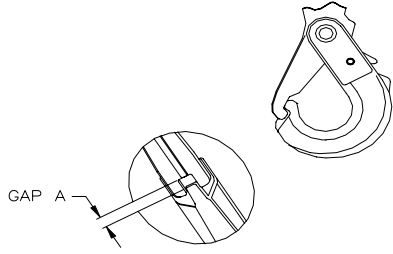

Trade Size		(A) Max. Clearance			
		Material Handling		Personnel Handling	
MM	IN	MM	IN	MM	IN
5/6	7/32	3.2	.13	2.2	.09
7/8	9/32	3.7	.15	2.7	.11
7	9/32	3.7	.15	2.7	.11
8	5/16	3.7	.15	2.7	.11
10	3/8	4.2	.17	3.2	.13
13	1/2	4.7	.19	3.7	.15
16	5/8	5.7	.23	4.7	.19

- **Never use a sling in extreme temperatures.**

"...alloy steel chain slings shall be permanently removed from service if they are heated above 1000°F..." – OSHA 1910.184(e)(6).

Alloy steel chain slings shall not be used while heated above 1000°F or cooled below -40°F.

Alloy steel chain sling Working Load Limits (WLL) given in TABLE 1, 2, 4, and 5 are valid between temperatures of -40°F and 400°F.

Alloy steel chain sling WLL shall be reduced in accordance with TABLE 9 when heated between 400°F and 1000°F.

Permanent WLL reduction shall be made in accordance with TABLE 9 for chain slings heated over 400°F. Identification tag shall be replaced and the new tag shall have the reduced WLL.

TABLE 9

Sling Component Temperature	Percentage of Table 1, 2, 3, 4 and 5 WLL	
	During Exposure	After Exposure
-40°F to 400°F	NONE	NONE
>400°F to 500°F	95%	95%
>500°F to 600°F	90%	90%
>600°F to 700°F	82%	85%
>700°F to 800°F	75%	80%
>800°F to 900°F	65%	75%
>900°F to 1000°F	60%	70%

- **Never use a sling in alkaline or acidic conditions.**

Gunnebo Lifting's GrabiQ Grade 100 (G10) alloy steel chain and components shall not be used in alkaline or acidic conditions. Resulting metal embrittlement and accelerated corrosion can cause sudden sling failure. Hot dip galvanizing and electro-zinc plating of alloy steel chain shall be done only by Gunnebo Lifting.



## GrabIQ™ **ADVANTAGES**

- Never more than 3 fittings at the top of the chain sling
- Built-in shortening pockets available for every leg
- Grade 100 for increased capacity - About 25% more than Grade 80
- Reduced sling weight in most cases
- Reduced fittings to simplify rigging
- More flexibility for riggers
- Quicker inspections
- Distinctive colors to easily determine grade
- Fewer bearing points for reduced wear and increased sling life





**Gunnebo Johnson Corporation, USA**

Tel: +1 918 832 8933  
E-mail: sales@gjcorp.com  
www.gunnebojohnson.com

**Gunnebo Industries Pty Ltd, AUSTRALIA**

Tel: +61 2 97 565 544  
E-mail: general.info@gunneboindustries.com.au  
www.gunneboliftingibc.com.au

**Gunnebo Industries Ltda, BRAZIL**

Tel: +55 11 4055 9800  
E-mail: gunneboindustries@gunneboindustries.com.br  
www.gunneboliftingibc.com

**Gunnebo Industries Co. LTD, P.R. of CHINA**  
(Kunshan)

Tel: +86 512 5525 2200  
E-mail: info@gunnebolifting.cn  
www.gunneboliftingibc.com

**Gunnebo Industries GmbH, GERMANY**

Tel: +49 273 989 720  
E-mail: info@gunneboindustries.de  
www.gunneboindustries.de

**Gunnebo Industries Ltd, IRELAND**

Tel: +353 1 4584 836  
E-mail: Ireland@gunnebolifting.com

**Gunnebo Anja Industrier AS, NORWAY**

Tel: +47 561 933 00  
E-mail: sales@gunneboindustrier.no  
www.gunneboindustrier.no

**Gunnebo Industries Sp.zo.o., POLAND**

Tel: +48 552 422 926  
E-mail: zawiesia@gunneboindustries.pl  
www.gunnebolifting.pl

**Gunnebo Industries (Pty) Ltd, SOUTH AFRICA**

Tel: +27 11 614 6078  
E-mail: info@gunneboindustries.co.za  
www.gunneboliftingibc.com

**Gunnebo Industrier AB, SWEDEN**

Lifting Systems  
Tel: +46 31 76 43 700  
E-mail: gbg@gunnebolifting.com  
www.gunnebolifting.com

**International Sales**

Tel: +46 220 384 00  
E-mail: export@gunnebolifting.com  
www.gunneboindustries.com

**Gunnebo Industries Ltd, UNITED KINGDOM**

Tel: +44 152 752 2560  
E-mail: sales@gunneboindustries.co.uk  
www.gunneboindustries.co.uk

For more information  
**8 0 0 3 3 1 - 5 4 6 0**



**GUNNEBO JOHNSON**  
CORPORATION

Copyright © Gunnebo Industries. All rights reserved.